

Design, Operation and Training Manual for an Intensive Culture Shrimp Hatchery



Granvil D. Treece
© 1970

Granvil D. Treece
Joe M. Fox

TAMU-SG-93-505
\$20.00



Design, Operation and Training Manual for an Intensive Culture Shrimp Hatchery

(with emphasis on *Penaeus monodon* and *Penaeus vannamei*)

Granvil D. Treece
Sea Grant College Program
Texas A&M University

and

Joe M. Fox
Pesca S.A.
Guatemala, C.A.

TAMU-SG-93-505
July 1993

Copyright ©1993 Texas A&M University Sea Grant College Program
All rights reserved.
Printed in the United States of America.

Texas A&M University Sea Grant College Program
Publication TAMU-SG-93-503
ISBN 1-883550-02-5

For more information on Texas A&M Sea Grant publications, contact:
Sea Grant Program
Texas A&M University
2nd Floor, Building 306
4700 Avenue U
Galveston, Texas 77551

TAMU-SG-93-503
1 M July 1993
NA16RG0457-01
A/F-1

Purpose of this Manual

In 1986 there was a perceived need for more written information on intensive shrimp hatchery management, especially with *P. monodon* and *P. vannamei*, and especially for training purposes.

In compiling the information in this manual, the intent has been to survey existing information about intensive penaeid shrimp hatcheries to develop the production procedures needed to maximize the efficiency of the hatchery and minimize the length of time that it takes to train personnel in the procedures. The underlying question is: what is presently known and what needs to be known to operate a commercial hatchery efficiently?

This manual has been organized into three main parts (Design, Operation and Training) within nine chapters. The design part focuses on two hatcheries (one for each species) and gives detailed plans of their construction as well as other options. The operation portion of the manual details the procedures for most efficient operation of a specific hatchery. The training portion of the manual consists of compiled, presently known (background or historical) information thought to be important for training new personnel. Hopefully this compiled material will also serve as reference material if future problems are encountered. Having historical or background material as well as current or "state-of-the-art" technology available makes it easier to solve problems. Each hatchery is unique with its own set of requirements. The next best thing to experience is having a broad-based reference collection or library at hand. It is the intent of this manual to provide a single publication that will cover most of the important steps in intensive larval shrimp culture, will act as a single reference to our present knowledge on the subject and/or will be a source of information.

It is hoped that there is enough detail in this manual to provide the newcomer with an adequate amount of knowledge presented in laymen's terms to run a hatchery and, at the same time, provide details and new technology to assist the experienced hatchery manager.

Acknowledgements

In addition to those acknowledged at the end of each chapter and in the literature citations, the authors would like to thank those “pioneers” in the shrimp aquaculture field who have paved the road to penaeid shrimp larval culture — those people who have spent their lives discovering, testing, publishing and sharing results. These are the people who have discovered and published the information through the years that has been compiled in this manual. It is also their discoveries that were used as a basis for the specific procedures that worked to make the Dian Desa hatchery more efficient. Some of these “pioneers” are Fujinaga, Cook, Murphy, Mock, Motoh, Platon, Kittaka, Liao, Salser, Yang, Shigueno, Shokita, Tabb, and Villaluz, just to name a few.

Some of the more recent workers in this field who also contributed significantly through their work and publications are Johns, McVey, Tseng, Howell, Simon, Wilkenfeld, Lightner, Johnson, Redman, Primavera, Qunitio, Laramore, Tang, and many more.

Special thanks go out to the U.S. Agency for International Development, Development Alternatives Inc., Central JAVA Enterprise Development Project, and the Indonesian Government. Members of these agencies that deserve an extra special thank you are Jim Boomgard, Anton Sudjarwo, Mumuk Soebagiyo and Pa Dibo for their assistance and friendship.

We also would like to thank the SEAFDEC people for their cooperation in releasing copyrights to some of the information presented herein.

Thanks go to Sea Grant for providing a working atmosphere that allowed this manual to be completed, to Cindy Liles, Lynn Propes and Debbie Hermann for processing the manuscript, Amy Broussard, Melissa Hightower and David O'Neal for editing and to Drs. James McVey, Robert Stickney and Bart Baca for reviewing the manuscript and offering valuable suggestions.

Table of Contents

Hatchery Site Selection, Design Criteria, Engineering and Construction	1
Introduction	1
Background	1
Small Hatcheries	2
Big Hatcheries	3
Maturation Facilities.....	3
The Hatchery Cycle	3
The Future	4
Freshwater Availability	5
Electrical Support	5
Market Considerations.....	5
Availability of Skilled Labor	5
Availability of Building Materials.....	5
Availability of Mated Females.....	6
Feed Distributors	6
Extension Assistance	6
Competition with Other Operations	6
Expansion Potential.....	6
Evaluating the Site	6
Hatchery Site Evaluation/Selection	6
Design Criteria, Engineering and Construction	11
Preliminary Considerations	11
Approach to Culture	11
General Layout of the Hatchery	11
Modular Concept for Future Expansion	11
Culture Tanks	12
Sizing the Hatchery	12
Specific Hatchery Background	20
Central American Facility (Hatchery Example)	20
Maturation and Hatching	51
Species Matured in Captivity	51
Maturation	51
Research History	51
Maturation-Hatchery Research Highlights in the United States	52
Important Parameters for Maturation	53
Other Parameters to Consider	54
Additional Considerations for Optimum Maturation	54
Sources of Broodstock	55
Sourcing <i>P. monodon</i> in Indonesia	55
External Characteristics of Adult Penaeid Shrimp	55
General Reproductive Characteristics	55
Male Reproductive System	55
Female Reproductive System.....	58
Size at First Maturity and Mating	59
Ovarian Maturation/Staging Mature Shrimp.....	60
The Shrimp Egg	60
Mating of Open-Thelycum Shrimp	61
Mating of Closed-Thelycum Shrimp	62
Spawning and Rematuration	62
Fecundity	63
Hormonal Control	63
Eyestalk Ablation Background and Research	64
Maturation Feeds.....	64
Broodstock Operations	65
Broodstock Receiving and Shipping	65
Broodstock Holding Ponds	65
Broodstock Distribution and Feeding.....	66
Ablation of Female Broodstock at Dian Desa Hatchery	68

Tank Volume Determination	70
Record Keeping	77
Spawning and Hatching	78
Transferring Nauplii	78
Disinfection Procedures	78
Selected Maturation References	78
Larval Rearing	83
Introduction and Background	83
Daily Larval and Postlarval Rearing Schedule	83
Larval-Rearing Tank Preparation Before Use	84
Other Environmental Conditions of Importance	87
Larval Staging, Feeding and Observations	89
<i>Artemia</i> Enrichment	92
Formula	92
For Use with Hatching <i>Artemia</i>	92
For Use with Hatched Separated <i>Artemia</i> (in seawater)	93
Algae Culture (in Support of Larval Rearing)	93
Growth Medium	93
Commercial Application and Community Method of Algae Production used by Continental Obtaining Cultures	93
Fisheries, Ltd., Panama City, Florida	95
Growth Characteristics	95
Culture Techniques	95
Filtration, Sterilization, Disinfection	96
Comparison of Disinfection Methods	99
Other Disinfection Methods	99
Centrifugation Washing, Antibiotics or other Chemicals	99
Counting Algal Cells and Determining Amount to Feed Larvae	99
Alternate Explanation of Algae Cell Counting and Determining Amount of Feed	100
The Use of the Hemacytometer	100
Preparation of Sample and Hemacytometer	100
How to Calculate Algae Culture Requirements Based on 60,000 Liter Larviculture Capacity	101
Alternate Larval Diets	101
Egg Diet Preparation for Penaeid Larvae (<i>Mysis</i> I or older)	101
Cooking Directions	102
Feeding Directions and Application Rates	102
Microencapsulated Diets	102
Omega Yeast	102
Signs of Larval Stress, Diseases and Treatments at Dian Desa	102
More Detail of Treatments	103
Harvesting Larval-Rearing Tanks at Dian Desa	103
Selected References	103
Postlarval Holding and Rearing in Circular Raceways	107
Raceway Description	107
Raceway Tank Preparation and Operation	107
Raceway Stocking	108
Postlarval Feeding	108
Daily Inspection	109
Diseases and Treatments at Dian Desa	110
Records	110
Identification of Postlarvae and Recognizing Healthy, Desirable or Undesirable Larvae	110
Harvesting Postlarvae	113
Alternate Production Strategies for the Yayasan Dian Desa Hatchery	115
Maturation	115
Larval Rearing	115
Postlarval Rearing	115
Alternate Production Strategies	115
Shrimp Toxicology and Shrimp Diseases	119
Shrimp Toxicology	119
Organic Chemicals Other than Petroleum	119

Industrial Organic Chemicals	119
Polychlorinated Biphenyls	119
Pesticidal Chemicals	121
Organochlorines.....	121
Organophosphates and Carbamates.....	122
Petroleum	122
Heavy Metals	123
Cadmium (Cd)	123
Iron (Fe)	124
Copper (Cu)	124
Mercury (Hg)	124
Zinc (Zn).....	125
Lead (Pb)	125
Nickel (Ni).....	125
Manganese (Mn).....	125
Magnesium (Mg)	125
Aluminum (Al).....	125
Treatment of Heavy Metals	125
Biological Agents	126
Biochemical Agents	126
Infectious Pathological Agents	126
Interactions of Pollutants, Pollutant Mixes and Other Factors in Penaeid Shrimp	127
Pollutant-Salinity Stress Interactions	127
Pollutant-Temperature Stress Interactions	127
Pollutant-Pollutant Interactions	127
Pollutant-Natural Disease Interaction	127
Larval Diseases Overview.....	128
Larval and Juvenile Shrimp Diseases Detail	131
Infectious Diseases.....	131
Bacterial and Fungal Diseases.....	134
Fluorescent Bacteria	136
Luminous Bacteria	136
Fungi	137
Protozoan Parasitic Diseases	138
Noninfectious Diseases	138
Bacterial epicommsals.....	138
Protozoan epicommsals.....	139
Algae	139
Nutritional, Toxic and Environmental Diseases Detail	139
Nutritional Diseases	139
Toxic Diseases	139
Methods for Routine Examination of Larval Shrimp	141
Particular Examinations.....	142
Methods for Routine Examination of Juvenile and Adult Size Shrimp	142
Particular Examinations.....	143
Media and test procedures of special importance in presumptive identification of	
bacteria	143
Virological.....	146
Rickettsia/Chlamidia detection.....	147
Fungal	147
Protozoological	147
Helminthological (Flukes, Acanthocephalans, and Tapeworms)	147
Specific Pathogen Free (SPF) Shrimp.....	148
Acknowledgments	148
Selected Recent Shrimp Toxicology and Disease References	148
Drugs Used in Shrimp Hatcheries as Chemotherapeutants	155
Necessity of Antibiotics (Chamberlain, 1988).....	155
Problems with Antibiotics	155
General Use of Antibiotics.....	155
Common Drugs Used in World Hatcheries as Chemotherapeutants and Applicable	
Dosages	155

Chemotherapeutants in United States Shrimp Hatcheries	156
Oxytetracycline	159
Trifluralin (Treflan)	159
Compounds to be Replaced	159
Needed Chemotherapeutants	160
Results of Larval Rearing and Postlarval Rearing Trial Runs at Yayasan Dian	
Desa Hatchery	161
Other Information about the Raceways	168
Recommendations	168
The Hatchery As A Business	169
Introduction	169
The Manager's Role	169
Planning	169
Sample Annual Business Plan	169
Accounting/Bookkeeping	170
Hatchery Capital Flow	170
The Purpose of Accounting	170
The Monthly Profit and Loss Statement	170
Notes on Operating Expenses	170
The Yearly Profit and Loss Statement	171
The Annual Balance Sheet	171
Marketing	171
Packaging	171
Delivery	173
Customer Relations	173
When To Do Marketing	173
How Much Is Necessary	173
Types of Marketing	173
Summary	173
Hatchery Cash Flow Example	174
Monthly Cash Flow	176
Large U.S. Hatchery Description	179
Large Hatchery Postlarval Disposition	179
Large Hatchery Production Summary	179
Large Hatchery Postlarvae Costs	180
Large Hatchery Postlarvae Production and Disposition by Month (s)	180
Actual and Projected Large Hatchery Operating Costs 1989-1995	181
1990-1991 Equipment Price List for Central American Shrimp Hatchery (in U.S. \$) with a Production Capacity of 10 Million Postlarvae/Month.	182
Aquaculture Equipment Suppliers	186
New Research Developments for 1993	186
Adding Enteromorpha to Broodstock Diet	187

List of Figures

1	Location of Java	21
2	Location of Hatchery on Java	22
3	Dian Desa Hatchery	23
4	Front and Side View with Elevations	24
5	Front and Back View with Elevation	24
6	Hatchery Overview with Detail	25
7a	Original Seawater Systems	26
7b	Final Seawater System	27
8	Artemia Production Area	29
9	Laboratory and Algae Production in Fiberglass Polytanks	29
10	Laboratory Work Bench	30
11	Carboy Stand for Algae Production	30
12	Various Maturation Systems	31
13	Maturation Tank Detail	31
14	Typical Raceway Design (Postlarvae)	32
15	Spawning Tank Detail	32
16	Larval Culture Area	33
17	Larval Rearing Approach #2 (Continuous Feeding)	33
18	Various Larval Rearing Tanks	34
19	Larval Rearing Tank Detail	34
20	Raceway Tank Detail	35
20a	Central American Hatchery Facility	35
20b	Conceptual Drawing of Seawater Intake Central American Facility	36
20c	Central American Hatchery Foundation/Levels	36
20d	Central American Hatchery Rooms and Dimensioning	37
20e	Central American Hatchery Tanks/Location	37
20f	Conceptual Drawing of Central American Hatchery Seawater Treatment	38
20g	Central American Hatchery Seawater Elevated Header Distribution System	38
20h	Central American Hatchery Maturation Facility Seawater Distribution	39
20i	Central American Hatchery Blower Aeration System	39
20j	Central American Maturation Facility Aeration Distribution System	40
20k	Central American Hatchery Drainage System	40
20l	Central American Facility Maturation Tank Design	41
20m	Central American Hatchery Larval Rearing Tank	41
21	Lateral View of Adult Female <i>Penaeus setiferus</i>	56
22	Dorsal View of Adult Shrimp	56
23	Details of Male and Female Reproductive System	57
24	Details of Male Shrimp Reproductive System	57
25	Male Reproductive System	58
26	Details of Male and Female Reproductive System	58
27	Quick Identification of Selected Species	59
28	External Appearance of the Ovaries of <i>P. monodon</i> at Different Stages of Maturity	60
	as Seen Through the Dorsal Exoskeleton	
29	Development of Different Egg Types of <i>Penaeus monodon</i>	61
30	Courtship and Mating of <i>P. monodon</i>	62
31	<i>Penaeus vannamei</i> and <i>monodon</i> Length to Weight Conversion	66
32	Length and Weight Data Sheet	68
33	Feed Rate Determination	69

34	Weekly Schedule of Maturation Activities	72
35	Maturation Tank Log	73
36	Actual Egg-Nauplii Data Log	74
37	Maturation/Hatchery Egg-Nauplii Data Log	75
38	Larval-State of Health	76
39	Larval Rearing Tank Data Log	84
40	Shrimp Larval Stages	86
41	Naupliar Substages	88
42	Zoeal Substages	88
43a	Some Commonly Cultured Microalgae	88
43b	Typical Phytoplankton Culture Growth	88
44	Myses and Postlarval Substages	89
45a	Stages of <i>Artemia</i> Development.....	90
45b	<i>Artemia</i> Hatching Cones	90
46	Counting <i>Artemia</i> When Concentrated and Hensen-Stemple Pipet	91
47	Typical Cycle Used in Algae Culture	92
48	Glass Carboy	96
49	Typical Algae Culture Rack.....	96
50	Recommended Ozone Levels and Formula for Checking Ozone Residual	98
51	Hemocytometer	100
52	Chemical and Antibiotic Treatments Used in Philippine Hatcheries	156
53	Forms Used for the Calculation of Drug and Chemical Requirements for Each Tank, Morning and Evening.....	158

List of Tables

1	Suggested Larval-Culture Sequences and Postlarval Feeding for Yayasan 85 Dian Desa Hatchery, Jepara, Indonesia
2	Classes and Species of Microalgae Presently Under Culture 89
3a	Guillard's F/2 Algal Culture Medium 94
3b	The Philippines Method of Algae Culture 94
3c	Indonesian Method of Algae Culture 94
4	Alternate Postlarval Feeding Guideline/Feed Requirement/Feed Costs per Month 111
5	Postlarval Holding and Rearing Data Log 112
6a	Polychlorinated Biphenyls and Penaeid Shrimp 120
6b	Organochlorine Pesticides and Penaeid Shrimp 120
6c	Petroleum and Penaeid Shrimp 122
7	Diseases Found in the Developmental Stages of Penaeid Larvae and Their Control Methods 129
8	Penaeid Viruses and Their Known Natural and Experimentally Infected Hosts 132
9	Routine Prophylactic Treatments for Shrimp Larvae 156
10	Alternate Method of Larval Culture Sequences, Postlarval Feeding Regime and Disease Preventive Schedule Used by Josh Vilkenfeld, Aquatic Farms, Ltd., 1989 157
11	Actual Larval Rearing Tank Log for Tank Number 1 162
12	Actual Larval Rearing Tank Data for Tank Number 2 164
13	Actual Postlarval Rearing Tank Log for Raceway Number 7 166
14	Actual Postlarval Holding and Rearing Data for Raceway Number 8 167

Photograph Legend

1. Seasonal harvest of wild postlarvae with scissor nets from the Pacific beach in Bahia, Ecuador
2. Example of large hatchery in Ecuador
3. Generators
4. Bamboo Fishing Platforms Offshore (nets are lowered at night with light above to attract catch)
5. Palm Leaf Barrier ("pound net" arrangement) with fisherman's platform at end where net is raised
6. Fishing Village located next to hatchery
7. Proud fishermen who bring in Broodstock Shrimp when yellow flag is flying and hatchery is in need of new stock
8. Yayasan Dian Desa front entrance
9. Dian Desa Hatchery side view
10. Maturation room (Unit II)-lower left, Generator Building, center; Seawater settling-lower right
11. Air blower for Unit I Hatchery (high volume, low pressure), later moved inside
12. Close up of air blower and filtered intake
13. Two, Schedule 80, three-inch PVC Intake Pipelines (one intake in shallow water and one in deeper water)
14. Concrete holds intake pipes in place visible at low tides
15. Seawater pumps work on a demand system and use is rotated (only one runs at a time)
16. "Home-made" sand filters used in 1986, but were replaced by slow sand filter in 1987 (#13)
17. Cement settling tank and cement slow sand filters, primary reservoirs and overflows
18. primary reservoir: Note organic matter floating and finished product (clear water)
19. Close up of primary, settling, slow sand, and clean water in overflow
20. Elevated reservoir (50 MT) acts as a constant head device for Unit I and Unit II (U.V. treatment takes place in head device reservoir. Pumps and D.E. filters are housed in structure below elevated reservoir)
21. Unit I, (right) outside postlarval holding and rearing tanks, under construction. Elevated Reservoir, staff housing (left)
22. Diatomaceous Earth filters housed inside elevated reservoir structure
23. Algae production in 300 liter fiberglass tanks
24. Algae production in 19 liter or 5 gallon, clear plastic bottles (these are safer to handle and transport than the glass but are more difficult to clean)
25. Rectangular Larval Rearing and PostLarval Rearing and holding tanks in use at nearby hatchery
26. Hatchery effluent flow returning to ocean "downstream" of intake
27. Maturation room (note low light level)
28. Maturation tank (400 cms. in diameter constructed of Ferro cement, painted black on inside)
29. Acclimating Broodshrimp for temperature and salinity before placing in maturation tank
30. Measuring Broodshrimp to get a length to weight conversion for tank biomass estimate. This female was 355 mm long and weighed 450 grams (one pound!)
31. Squid, purchased from local fishermen, are kept frozen until fed as maturation food (Squid makes up 50-75% of the diet)
32. Small shrimp are also purchased locally and kept frozen until needed to supplement the maturation diet (they are thawed and fed whole)
33. Maturation food is weighed so that over-feeding does not begin to degrade oceanic quality water (an inexpensive plastic scale is used)
34. All of the maturation food is spread evenly around the tank at 4 different feeding intervals during a 24-hour period
35. Excess food and debris is siphoned from maturation tanks twice a day to maintain oceanic quality water

36. Broodshrimp settling in and eating squid; some are more stressed than others upon arrival and appeared red in color and swim at the surface until they too settle in
37. Healthy Broodshrimp about one week after stocking; ready for ablation and to be placed in production
38. Demonstrating proper ablation technique (holding 450 gram female Broodstock just under water surface with one hand and removing contents of one eye with the other hand. Contents have been removed in the right eye)
39. A soft nylon net is used to capture brood from ablation or just for inspection
40. Constant water level maintained in maturation tank by this dual standpipe (water being drawn from the bottom of the tank at this point, but by removing the outer standpipe water can be "skimmed" from the upper surface in case there is excess food floating)
41. Effluent flow rate is checked daily at the maturation tank in order to maintain a constant, stable environment
42. Fresh molt on the bottom of maturation tank
- 43.. Salinity readings are taken routinely once a week unless during the rainy season (then refractometer readings may be required more often)
44. Molts are removed after they are no longer a good food source (usually within 24 hours and they have turned yellow-gold)
45. Using inexpensive underwater light (attached to PVC pole) to locate late stage female shrimp
46. Flashlight can be placed such that light beams shows through exoskeleton and stage of developing female is determined
47. Records are kept for the day on a formica board hung near each tank
48. The daily records from the formica boards are kept on a clipboard for easy reference in the event there is a problem
49. Late stage females are placed individually in a series of 800 liter spawning tanks, each equipped with water inflow and screen standpipe
50. Counting egg and nauplii out of a 100 ml beaker subsample taken from the spawning tank (note inflow and effluent screen with air collar)
51. Larval rearing tank approximately one-half full (1 micron filter cartridge on inflow; central, screen standpipe with air collar and 100,000 cells/ml algae)
52. Larval rearing area (Series of larval rearing tanks; some covered with plastic during evening hours to keep temperature up)
53. 4,000 liter Larval rearing tank filled to capacity
54. Siphoning off freshly hatched *Artemia* nauplii after settling (note the stratified layers; the bright orange layer is nauplii)
55. Laboratory work bench with balance and chemical storage
56. Algae lab behind closed doors in air-conditioned room
57. Algae production in small flasks
58. Algae production in glass jars (wide mouth allows easy access for cleaning jar)
59. Figure 50, typical algae room arrangement
60. Figure 50, typical algae room arrangement
61. Postlarval rearing and holding area
62. Postlarval holding and rearing tank (15ft.-dia., ferro cement, circular, holding approximately 12 tons, airlifts and screen habitats)
63. Feeding postlarvae a finely ground pellet
64. Siphon used to clean PL holding tank when necessary
65. Postlarval rearing and holding data board (formica board located near the tank)
66. 1,000 liter plastic containers used to transport postlarvae
67. Example of a fiberglass postlarval transport tank

Glossary of Selected Terms

ablation	Extripation, removal or otherwise damaging the eye in some manner to promote maturation.
<i>Artemia</i>	Brine shrimp.
aseptic	Sterile.
axenic	Free from other living organisms.
bacteria	One-celled organisms that can only be seen with a microscope. Compared to protozoans they are of less complex organization and are much smaller in size.
broodstock	Larger animals that are sourced and expected to produce offspring in the maturation facility.
carboy	Glass bottle.
cysts	Eggs of <i>Artemia</i> that are in a dormant stage.
decapsulation	Removal of the thick outer layer on <i>Artemia</i> cysts.
disinfection	Reduction of bacterial numbers to a "safe" or "acceptable" level.
exoskeleton	Shell of the shrimp.
grooves	There are numerous grooves on a shrimp. Some are used as an aid in identifying the species. Examples: The "thumbnail" grooves on the last abdominal segment of tropical Atlantic brown shrimp distinguish them from similar white shrimp; The length of the rostral groove is shorter in <i>P. monodon</i> than in <i>P. semisulcatus</i> and can be used as one way to distinguish the two similar species. Other distinguishing characteristics can be seen in Figure 27.
hemacytometer	Device used for counting algae cells (Figure 51).
hemolymph	Blood.
Hensen-Stemple pipet	Pipet used to take an objective water sample (Figure 46).
hepatopancreas	Digestive gland.
larvae	Plural of larva and the stage in the development of a shrimp's life cycle between the egg and the juvenile.
maturation	The act of maturing (In the case of white shrimp, egg development, mating and then spawning; with brown shrimp, mating, egg development and spawning).
media	Plural of medium and in this case refers to saltwater and nutrients or food added to promote proper growth either of algae, larvae, etc.
molt	For shrimp, shedding of the exoskeleton.
nauplii	Plural of nauplius and the first of three major larval stages. It is a non-feeding stage and is the best stage to transport the animals until they reach the postlarval stage.
penaeid	The family, superfamily and an infraorder of shrimp distinguished from the caridean shrimp by the shape of the second segment of the abdomen. The sides of the penaeid shrimp shell (known as the pleura) overlap each segment that is behind it. In the caridean shrimp the pleurum of the second segment overlaps both the first segment and the third, making the second segment look very large. There are 109 species of penaeid shrimp listed by the Food and Agriculture Organization of the United Nations (F.A.O.).
petasma	Male shrimp reproductive structure.
prawn	According to Dore and Frimodt (1987), different people use this name to mean and to apply to quite different species. Examples: U.K.: larger than shrimp. U.S.: restaurants use it to mean large shrimp and other places mean small shrimp or freshwater shrimp Norway: producers promote the northern shrimp <i>Pandalus</i> as a prawn, and the "Dublin Bay prawn" is even used to describe <i>Nephrops</i> , which is a langoustine or Norway lobster.

The Oxford Dictionary defines prawn as "larger than shrimp" whereas Webster's Dictionary describes it as "a small, edible crustacean of the shrimp family."

South Africa: larger animals are prawns; smaller animals are shrimp.

F.A.O. attempted to introduce a clear-cut definition as early as 1967. At the World Conference on the biology and culture of shrimps and prawns held in Mexico City, it was agreed that the term "prawn" was to be reserved for freshwater creatures only, while their marine/brackish water relatives were to be called "shrimps." Unfortunately, despite all of their efforts, the confusion continues. The only point on which everyone can surely agree is that the use of "prawn" in the English language is confusing and unclear, and should be avoided.

protozoa

New world term of zoea or the second major larval stage of penaeid shrimp.

raceway

A small pond or tank that is usually rectangular with a center divider or circular tank with a water flow that "races" around the tank.

rostrum

The pointed prow that extends from the head of most shrimp.

setae

Hair-like structures that appear to branch off of appendages or legs.

sourcing

Obtaining animals to be used for brood stock.

spore

A small cell that can develop into a new individual.

spp. or sp.

Plural and singular abbreviations for species, respectively.

sterilization

Total inactivation of all microbial life.

thelycum

Female shrimp reproductive structure.

Hatchery Site Selection, Design Criteria, Engineering and Construction

Introduction

There is a perceived need for more written information on intensive shrimp hatchery management, especially with *P. monodon* and *P. vannamei*, and especially for training purposes.

In compiling this manual, existing information on intensive penaeid shrimp hatcheries has been surveyed to develop efficient production procedures and minimize personnel training time. The underlying question is what is presently known and what needs to be known to operate a commercial hatchery efficiently?

The manual is organized into three main parts — design, operation and training — in nine chapters. Design focuses on two hatcheries (one for each species) and gives detailed plans for construction as well as selected equipment options. The operation portion details the most efficient procedures for a specific hatchery, and the training portion consists of compilations of background or historical information thought to be important in training new personnel.

Hopefully, this material will also provide a reference if future problems are encountered, since having historical or background material as well as current or “state-of-the-art” technology available makes it easier to solve problems. Each hatchery is unique with its own set of requirements. The next best thing to experience is having a broad-based reference collection or library at hand. It is the intent of this manual to provide a single publication that covers most of the important steps in intensive larval shrimp culture, acts as a single reference to our present knowledge on the subject and/or is a source of information. It is hoped that there is enough detail in this manual to provide the newcomer with adequate knowledge in laymen’s terms to operate a hatchery and, at the same time, provide details and new technology to assist the experienced hatchery manager.

Background

Shrimp of the family Penaeidae form the basis for one of the most valuable fisheries in the world. The highly esteemed quality and edibility of these shrimp, their relatively large size and their worldwide distribution have elicited a large investment of manpower and funds in the shrimp industry. Worldwide, the penaeid shrimp fishery is an annual multibillion dollar enterprise. According to Rosenberry (1992) the fishery is a 2 million metric ton (MT⁺) market of which 28 percent (or 700,000 MT⁺) were farm-raised in 1992.



Photo 1. Seasonal harvest of wild postlarvae with scissor nets from the Pacific beach of Bahía, Ecuador.

In the 1990s there will be thousands of shrimp hatcheries of all sizes operating worldwide, helping to supply “seed” or postlarvae to one of the most valuable industries in the world. In 1992, over 700,000 MTs of farm-raised shrimp were harvested (150,000 MTs from Thailand alone). Shrimp farmers now produce at least 28 percent of the 2.6 million metric tons of shrimp placed on world markets today, and this percentage has risen steadily since 1981.

These shrimp hatcheries help provide a more reliable supply of postlarvae for pond culture, especially since wild populations fluctuate unpredictably and are presently being harvested at or beyond their maximum sustainable yields. As a result of this exploitation of wild populations, many countries have placed restrictions on the collection of wild shrimp populations (see harvesting wild postlarvae, Photo 1). Shrimp hatcheries are helping to fill the demand for postlarvae and to relieve some of the pressures placed on the wild stocks. Undoubtedly, the lack of a reliable supply of postlarvae was once among the biggest sources of uncertainty, inefficiency and economic losses facing shrimp farmers worldwide. As time passed and we have become more familiar with the technology involved in shrimp reproduction and growout in captivity, these uncertainties do not seem so monumental. We still have a long way to go before we are totally independent of natural stocks, but the gap is closing quickly with the rapid technological advances that have occurred in shrimp hatcheries since 1985.

To solve the major limiting factor of insufficient availability of postlarvae, mass production in hatcheries has received much attention from researchers. The techniques

are now well known, although the results are not always satisfactory. The following three main methods are used:

- The Japanese method is characterized by low density of around ten larvae per liter, large tanks up to 200 m³, a need for numerous wild-caught gravid females, direct water fertilization by inorganic nutrients to promote algal bloom, and production of 20 to 30 day-old postlarvae. This method is well adapted to temperate conditions when it is necessary to produce the seed in a short period of time. But these large-volume tanks are difficult to control in tropical conditions and results are dependent on variations of water quality and light. If disease occurs, a curative treatment is almost impossible with such large volumes.
- In contrast, the intensive method is characterized by high density (100/l), small tanks between 1 to 10 m³, few gravid females, phytoplankton or *Artemia* production in separate culture systems and production of one to five day-old postlarvae (can be modified to produce older larvae if necessary). It allows accurate control of rearing for water quality, food quantity and quality, and diseases by preventive and curative treatment.
- The intermediate method is a combination of the first two methods with mean density (30/l), medium-size tanks (30 to 50 m³), and use of fertilization in the tanks to bloom an algal inoculum cultured separately.

These three methods differ mainly in degree of control and, when practiced by experienced personnel, give good results. However, it must be mentioned that many existing hatcheries suffer from a lack of reliability in results due to site conditions, inadequate control of algal quality and lack of knowledge of the necessary sanitary procedures such as regular dry-out to eliminate the resistant pathogenic bacterial strain problem that is always the most limiting factor in a hatchery operating year round in tropical conditions. In recently established hatcheries, these results have prompted physical separation of the different steps of the system in rooms that have independent water pipes and nets, that can be closed and dried regularly. At the commercial level, the result has been the development of large-capacity production hatcheries (10 to 20 million PL/month) in Japan, Ecuador and Panama as well as in small-scale hatcheries in Taiwan, Thailand and the Philippines. The present challenge is not to be able to produce postlarvae, but to optimize the techniques.

To reach the necessary reliability level and decrease production costs, research priorities have been focused on the following:

- Characterization of algal quality according to culture techniques
- Replacement of algae and *Artemia* by inert feeds (microparticles, microcapsules)
- Optimization and automation of the procedures (recirculation systems)
- Development of strict sanitary procedures like those routinely used for pig husbandry
- Cryopreservation of sperm, eggs and nauplii to be able to run the hatcheries by sequential period.

Shrimp-hatchery techniques are far from their optimum efficiency at a time when commercial operations are



Photo 2. Example of a large hatchery in Ecuador.

already profitable in some parts of the world under different socio-economic conditions. We can also look forward to major improvements that will lead to increased productivity with a parallel decrease in costs, which, in turn, will broaden the market.

It is important to analyze the reasons not only for success but also for failure. Technology can succeed only if applied under the right conditions. Many failures have been due to introduction of technology inadequate for specific site constraints and logistic availability.

The management of production units is also essential. Too often investors have focused their attention on biological and technological problems, forgetting the importance of routine decisions and procedures necessary for any business. Success depends on good management and technological advancements.

Shrimp hatchery activity is just emerging from its infancy. The success of the broiler industry was achieved only after more than 20 years of intensive scientific and commercial effort, and the shrimp industry will undoubtedly follow the same path. The rate of development will depend on how closely researchers will work with producers to identify the constraints and to integrate available techniques according to the socio-economic conditions of each country.

The accompanying schematic represents the different feeding regimes used worldwide for the developmental stages of penaeid shrimp and related culture parameters:

Hatcheries sell two products: nauplii (tiny, newly hatched larvae) and postlarvae (juveniles that have passed through three larval stages). Postlarvae are stocked in nursery ponds or directly into growout ponds. Nauplii are sold to specialists who grow them to the postlarvae stage or to farmers who stock them in nursery ponds at high densities and later transfer them to growout ponds at lower densities. Hatcheries come in two sizes—big and small.

Small Hatcheries

Small hatcheries are usually operated by a family group on a small plot of land. Called "mom-and-pop" or "backyard" hatcheries, they adopt a green thumb, non-technical approach. Their chief advantages are low construction and operating costs and their ability to open and close, depending on the season and the supply of wild

Larval Rearing Techniques of Penaeids

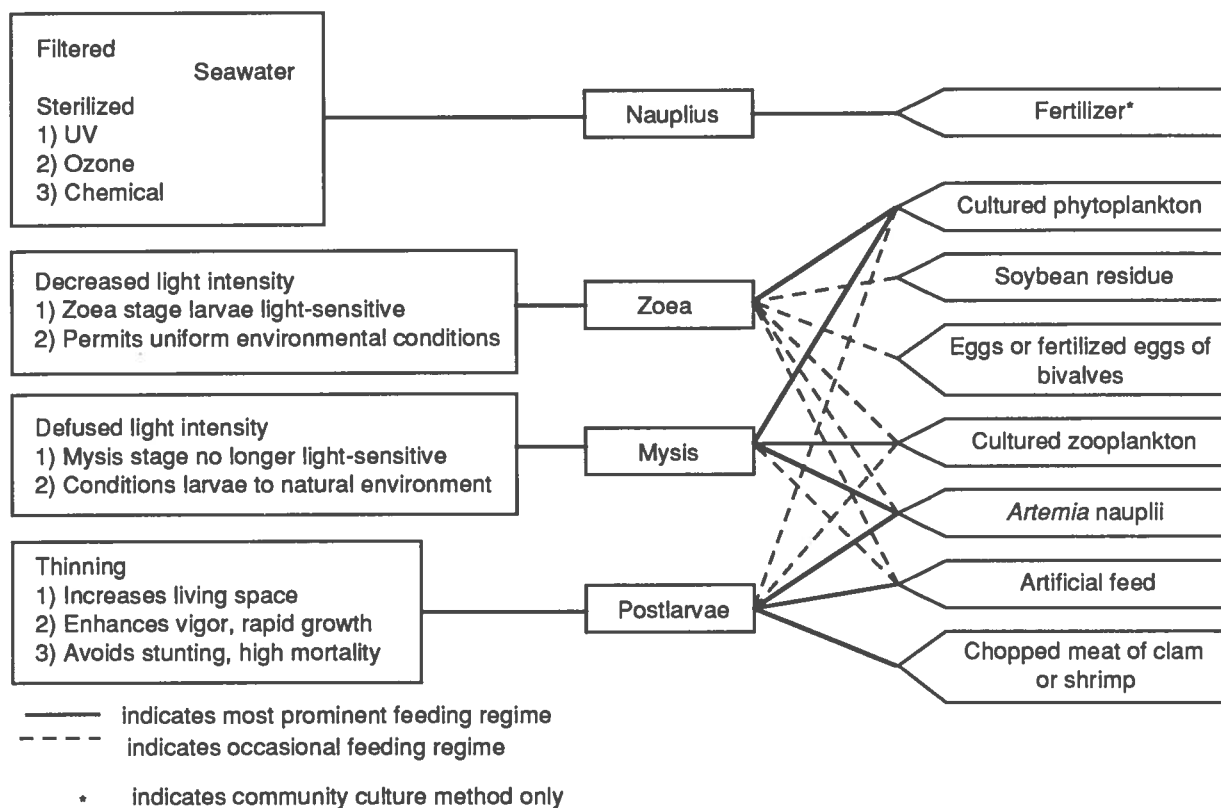

seed. They usually concentrate on just one phase of production, such as nauplii or postlarvae production. They use low densities and untreated water. Diseases and water quality problems often knock them out of production, but they can quickly disinfect and restart operations. Small hatcheries have achieved great success in Southeast Asia, particularly in Thailand, Taiwan and the Philippines.

Big Hatcheries

Big hatcheries are multi million dollar, high-tech facilities that produce large quantities of seedstock in a controlled environment. Requiring high-paid technicians and scientists, they work with high densities and clean water, attempting to take advantage of the economies of scale by producing seedstock throughout the year. When wild females and juveniles are readily available, big hatcheries have a difficult time competing with small hatcheries and fishermen who supply freshly spawned nauplii or wild postlarvae to farms. In Ecuador, farmers consider wild postlarvae the "Cadillac" of seedstock. Big hatcheries have problems with disease and water quality, and it takes them a long time to recover from production failures. In the western hemisphere, particularly in Ecuador, big hatcheries are the trend. Big hatcheries also supply most of China's seedstock, and big hatcheries are established in most of the major shrimp-farming countries (see example of large hatchery in Ecuador, Photo 2).

Maturation Facilities

Maturation facilities are big hatcheries that maintain captive broodstock to produce seedstock. They represent the future of the industry but, thus far, have been only

marginally successful. Some species are very difficult to mature in captivity. Other species, such as the western white shrimp, will mature in captivity, but it is a tricky, expensive proposition. The Chinese white shrimp, on the other hand, seems to be especially well suited to maturation facilities. Viral and bacterial diseases limit the development of successful maturation facilities.

The Hatchery Cycle

Whether pregnant shrimp are captured in the wild or matured in a hatchery, they invariably spawn at night. Depending on a number of variables (temperature, species, size, wild/captive and number of times previously spawned), they produce between 100,000 and 1,000,000 eggs. The next day, the eggs hatch into nauplii, the first larval stage. Nauplii, looking more like tiny aquatic spiders than shrimp, feed on their yoke sac for a couple of days. Then they metamorphose into zoeae, which have feathery appendages and elongated bodies but few adult shrimp characteristics. Zoeae feed on algae for about five days and then metamorphose into mysids. Mysids, the last larval stage, have many of the characteristics of adult shrimp, such as segmented bodies, bulging eyes and a shrimp-like tail. They feed on algae and zooplankton. This stage lasts another three days and then the mysids metamorphose into postlarvae. Postlarvae, looking almost like adult shrimp, feed on zooplankton, detritus and commercial feeds. After one to four weeks and almost daily molts, the postlarvae are stocked in nursery or growout ponds. The larval period lasts about two weeks and the postlarvae period four weeks, so from spawning to stocking in growout ponds takes about six weeks.

The Future

Hatcheries remain the weak link in the production cycle. Feeding the various life stages of developing shrimp takes a major effort. Hatcheries are plagued with management, disease and water-quality problems, yet they are constantly improving and constantly increasing production. Hundreds of researchers in a dozen countries work on unraveling the mysteries of hatchery production, and thousands of hatcherymen in all the shrimp farming countries work with new techniques, designs and ideas to improve hatchery production. When hatcheries become more reliable, the production of farm-raised shrimp will take another leap forward (Bob Rosenberry, *Aquaculture Digest*).

The system described in this manual is called the intensive culture system and can be conducted in either small or large hatcheries. The advantages of this system include the following:

- Low initial investment
- Only a small number of spawners required for one operation
- Larvae can be reared at high densities
- Easier to control diseases

This manual presents information on the intensive method — first by introducing hatchery site selection and design criteria, engineering and construction of two very similar hatcheries (one for *P. monodon* and one for *P. vannamei*) to show the similarities of procedures and design criteria as well as the subtle differences. Maturation, hatching, larval rearing, postlarval holding and rearing, diseases, chemotherapeutants, and the hatchery as a business is also discussed. The technologies discussed in this manual also can be modified slightly to include intensive culture of all penaeid species.

The hatchery site selection, design criteria, engineering and construction plans that follow are from two intensive hatcheries (one *P. monodon* hatchery in Indonesia and one *P. vannamei* hatchery in Central America).

Site Selection

Because the shrimp hatchery is concerned with the production of living animals that would otherwise be found in a marine or brackish-water situation, special consideration must be given toward selection of its location. The primary concern in situating a hatchery is water quality. Since shrimp spawn in the open ocean and larvae remain there until they become postlarvae, hatcheries should be able to access oceanic-quality seawater directly and have a year-round, constant salinity. Proper site selection also means proximity to the local market (farmers, middlemen, buyers, etc.), access to support industries and utilities, simplified engineering and construction, and integration with growout ponds. Another major consideration for hatchery site location is access to a disease-free broodstock supply. The following are important site selection criteria.

Distance from Ocean

As mentioned previously, hatcheries should be located on the coast adjacent to a large body of oceanic-

quality seawater. Most successful hatcheries obtain their seawater directly from this body of water with the understanding that the ocean is a fairly stable water source. The further a hatchery is located from the ocean, the more likely the facility is to experience difficulties in terms of pumping, water quality and access to broodstock.

Distance from Ponds/Access

There is no optimum distance between the hatchery and the pond market it supports; however, an optimum situation could be described as a hatchery centrally located among the ponds it supplies with postlarvae (PLs). This helps to reduce PL transport costs and transport mortality, and generally helps public relations with buyers. In Indonesia, hatcheries have been known to sell PLs to ponds more than 1,000 km from the hatchery, which requires air transport. This is also complicated by inter-island licensing procedures. A more practical situation would involve the majority of ponds being less than two to three hours, by car, from the hatchery. If road conditions are favorable (paved, well-maintained, low traffic, etc.), the maximum distance is primarily dependent upon quality of packaging. Some hatcheries in Ecuador transport PLs from the hatchery to the ponds by boat, but many are sent by air freight using direct runways near the pond sites.

Elevation and Topography

The chosen site should be flat and elevated above the maximum high tide mark but within reasonable pumping distance. A good rule of thumb is hatchery floor elevation of less than 3 to 4 meters above the maximum high tide mark and an overall pumping head (height) of less than 6 meters. Pumping cost versus elevation appears to be a fairly linear relationship up to a certain point. At times, the pumping requirement for even a small hatchery is in excess of 600 to 700 liters per minute, if operated properly. If the land is not flat, the expenditure on site development will increase due to increased excavation or filling. The site should be on fairly solid ground. A coral or stone base may be difficult to level, but will eventually mean a reduction in overall concrete required for the foundation. In some cases, concrete may not even be required. A foundation that uses a sand base will have a tendency to settle and will require additional concrete support.

Water Quality

The primary water quality considerations are pollution and fluctuations in seawater components within an optimum range. Very few bodies of water are pollution free and caution should be exercised when reading reports that make this claim. In choosing a hatchery site, locations adjacent to or within 30 km of a major river system should be avoided unless careful analysis of the watershed has been performed. This involves surveying all potential sources of industrial, municipal and agricultural pollution that impact that particular river. Nearby factory or plant personnel, farmers, etc., should be interviewed to identify possible pollutants. Most hydrocarbon, pesticide or heavy metal pollution is quite serious and should be avoided at all costs. The extent to which organic pollution (e.g. sewage outfalls) has affected a waterway is

somewhat more difficult to assess due to the inherent ability of the waterway to absorb nutrient offloading. A useful index of organic pollution is biochemical oxygen demand (BOD), which is an indicator of the biomass being supported by a body of water and how much oxygen it requires over a given period of time. High nutrient loads will support a high biomass (primary productivity, macrospecies, etc.) as long as oxygen is available. If this nutrient load is released into the ocean near the hatchery, it could result in blooms of disease-causing microbial species and place an excessive load on filtration equipment. Therefore, it is recommended that water chemistry sampling take place not only in waterways impacting the hatchery's near-shore environment, but also in the area around the potential hatchery intake. This sampling should occur during the rainy season, since runoff is greatest during this time of the year. Water chemistry sampling should be continued on a monthly basis once the hatchery is in operation.

Although water salinity is fairly easy to determine, it is one of the major problems encountered as a result of poor hatchery site selection. As a rule-of-thumb, all hatcheries should use water taken directly from the ocean, and prospective sites should not be located within 30 km of a major river-mouth. Hatcheries in Indonesia are often situated near rivermouths and, as a result, experience tremendous seasonal fluctuations in salinity. The optimum range in salinity for hatchery culture of penaeid shrimp is about 26 to 32 parts per thousand (ppt). Mature adult and postlarval shrimp are naturally found in the ocean, where the salinity is approximately 35 ppt (35 grams of salt per liter of water).

Water pH is seldom a problem in hatcheries that obtain their water directly from the ocean. The pH of seawater should fluctuate around 8.0 or slightly higher unless the body of water used as a source is polluted or is receiving a large amount of freshwater runoff. Occasionally, algal culture will be modified by enrichment with carbon dioxide resulting in lower pH, but this is not a characteristic required of the water source.

A very thorough water analysis for a potential hatchery site in South Texas can be seen in Appendix A, B and C of the Hatchery Site Evaluation/Selection section of this chapter.

Freshwater Availability

Freshwater must be available at the hatchery site both for cleaning and for the workers. Also, many nutrient-enrichment medias require preparation in fresh or distilled water. Often hatcheries are located in areas with very little or no ground water, or with water that is not potable and may fluctuate in its concentration of dissolved solids. The extent of the water table must be known before a well can be considered. It is too expensive to truck water to a site for this to be considered a viable alternative.

Electrical Support

Continuity is the most important criterion for electrical support. Electricity is used to power aeration devices, seawater pumps, algal culture lights and heaters (should they be required). Rural electricity is certainly a bonus, but should not be relied upon as the only source of power. A

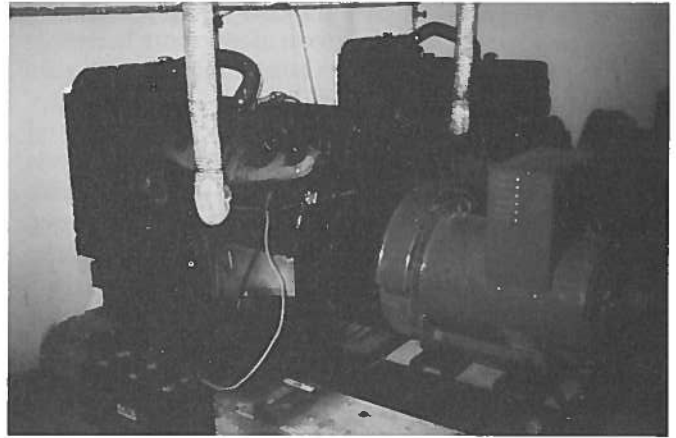

Photo 3. Generators

generator set large enough to run the entire hatchery is also recommended. If no rural electricity is available, two generator sets should be purchased. Rural electric power can be distributed more easily and can accommodate a larger demand than generator power, but it often can be more costly to run lines from the main power pole to the hatchery than to purchase two generators (Photo 3).

Market Considerations

Hatcheries often are built without consideration of demand or markets. If the hatchery is owned by a company that also owns growout ponds, the market is fairly secure (most of the fry will be stocked in company-owned ponds). If not, the best possible approach is to estimate the number of ponds in the local area that would be willing to buy PLs from a hatchery. This can be accomplished by visiting the local fisheries representatives or by talking with local pond farmers. Many times the market demand is based on a seasonal stocking strategy. There also could be some reluctance on the part of the pond farmers to buy PLs that have been produced in a hatchery. These factors must be determined prior to site selection.

Availability of Skilled Labor

Since it is usually quite expensive to import labor from outside the pond site area, and sometimes socially unacceptable, most hatchery developers turn to the local labor force for hatchery personnel. It is highly unlikely that a hatchery manager can be found in most rural areas, but a substantial proportion of the remaining personnel can be hired locally. It helps if this local group has at least some familiarity with hatchery concepts. Otherwise, extensive training is necessary, which increases hatchery start-up time and overall start-up costs.

Availability of Building Materials

Availability of suitable building materials (concrete, sand, gravel, wood, roofing material, paint, piping, etc.) at reasonable costs is another important consideration. Many times hatcheries are built in areas that possess excellent water quality yet are so far from material outlets that construction costs double. Sometimes contractors request specific materials in order to achieve a certain design but neglect to determine whether these materials can be bought locally. The further one locates a hatchery from a large

metropolitan area, the higher the cost of the material (if locally bought) or the higher the cost of transport. In remote areas, the quality of material can often suffer. Poor storage conditions can leave the contractor with little to choose from. An example is the use of volcanic sand in foundation and tank construction. This sand, if purchased in Indonesia (Yogyakarta area) would cost about Rp. 4,000 per cubic meter (U.S. \$4.68). In building a hatchery near Semarang, Indonesia, the contractor required roughly 1,000 cubic meters of this sand. Instead of paying the Rp. 4 million (U.S. \$4,680) he expected to pay, he eventually spent Rp. 14 million (U.S. \$16,380). The more remote areas of the world where hatchery site locations and water quality may be more desirable may also cost the owner double to build. This must be considered during the planning stage.

Availability of Mated Females

Some potential hatchery sites are located adjacent to large spawning grounds and can easily obtain a year-round supply of mated females (for production of eggs/larvae). This enables such hatcheries to reduce their operational overhead since they do not need to support a large maturation facility. This is also advantageous for site investigators since it reduces capital outlay on construction (smaller maturation facility containing only spawning tanks). Information on availability can best be obtained by visiting the local fisheries department representative and/or a local fishing village. Since offshore mating is seasonal in nature one should also ascertain the extent of the spawning/fishing seasons and to what extent access to these grounds is limited by the monsoon (or rainy season), which usually affects the mating season in some manner. A source of broodstock should be found within 100 km of the proposed hatchery site, if possible, and the stock should be disease free.

Feed Distributors

The availability of feed refers primarily to inert/formulated feed and *Artemia*. The cost of these feed items will increase in relation to transport distance. Some hatcheries bypass higher prices by buying *Artemia* direct from the United States while pelleted feeds are purchased from large importers in the local area. However, should a local feed distributor stock the particular brand of *Artemia* or feed to be used, that is only to the advantage of the hatchery owner. However, because of poor stocking strategies and supply, local distributors are sometimes found to be without quality feeds. Thus, it is recommended that before choosing a hatchery site some idea of feed availability from local distributors should be obtained. The more conscientious hatcheries choose to buy direct from importers or manufacturers. This is not so much an attempt to save money but an ensurance of availability.

Extension Assistance

Hatcheries are intensive culture systems. Being such, they are often plagued by various diseases of a nutritional and/or endemic nature. Furthermore, hatchery operators located in remote facilities sometimes feel that they are losing touch with current developments in the industry (new innovations, enhanced availability of previously limited supplies, government regulations, etc.). In order

to receive some assistance in circumventing disease (i.e. identification, prevention, treatment) it would certainly be advantageous to have some research institution in the vicinity. Identifying a local fisheries department representative in the area could help the hatchery owner/operator keep abreast of industry or fisheries development.

Competition with Other Operations

If the local market for postlarvae is quite large, then a little competition could be quite healthy in terms of the development of a shrimp hatchery. Often one hatchery may encounter unfamiliar problems that an adjacent hatchery has already solved. If these two hatcheries have a history of information exchange, both will benefit. Interaction is something that could be beneficial for the entire industry. A clandestine approach to assistance could prove detrimental later.

Should the local PL market be so small that it can support only one hatchery, it may be best to go elsewhere if such a hatchery already exists.

Expansion Potential

One aspect of site selection that is seldom considered is expansion potential should the market demand increase. Sometimes the site itself will not allow for expansion due to physical constraints or the area available for development.

Evaluating The Site (weighted ranking system)

- Most evaluations use this method
- Assigns relative weight of importance to criteria
- Assigns a score to each measurement or observation
- Result is weighted score versus ideal

Hatchery Site Evaluation/Selection

Site Evaluation

Range of Scores (%)	Scoring	Evaluation
100-80		Excellent site
79-60		Good to Fair
59-40		Marginal
Less than 40		Avoid site

Site selection is perhaps the most critical step in the development of a successful hatchery business. Selection of a suitable site can have a significant impact on the profitability of the business. Many unsuccessful hatcheries were troubled by site-related problems that were too difficult or expensive to correct. The ideal site for a hatchery probably does not exist anywhere in the world if all site selection criteria are considered. The decision to locate a shrimp hatchery at a specific site is usually based on whether the biological requirements of the shrimp can be fulfilled at a reasonable cost. Political stability and safety of the investment, as well as potential difficulties in recouping profits, must also be considered before the site selection decision is made. Five to ten acres (two to four hectares) is generally sufficient land to build a hatchery and accommodate future expansion.

A list of both general and detailed information needed for proper evaluation of a site follows.

General Information on Site

1. Location: _____

2. Map: _____

3. Access: _____

4. Wave Action: _____
5. Water Salinity: _____
6. Water pH: _____

7. Elevation Above Seawater Source: _____
8. Land Topography: _____
9. Benthic Topography/Description: _____
10. Seawater Inlet Distance From Site: _____
11. Type of Inlet Prescribed: _____
12. Water Depth at Inlet Site: _____
13. Pollution Potential: _____
14. Organics in Water?: _____
15. Turbidity: _____

16. Nearest River: _____
17. Source of Broodstock/Price/Conditions: _____

18. Electrical Power: _____
19. Freshwater Source: _____
20. Aquaculture Distributor: _____
21. Source of Trained Workers: _____
22. Potential for Well: _____

Detailed Information on Site

Land Details

1. Total Land Available _____
Expansion Potential? _____
2. Current or Previous Use _____
3. Owner _____
4. Cost of Land _____
5. Lease Terms Available? _____
6. Topography _____

Soil Details (for construction purposes)

1. Soil Samples Taken (by location)
Map of Sample Area

Location 1: Depths

Location 2: Depths

Location 3: Depths

2. Site Stability (determined by soil type) _____

Seawater Quality Details at Site

1. Potential Source _____
2. Distance from Site _____
3. Color of Water _____
4. Wave Action _____
5. Storm Potential _____
6. Beach Appearance _____
7. Erosion _____
8. Accretion _____
9. Freshwater Plume _____
10. Proximity of River _____
11. Salinity _____
12. Tidal Flux _____
13. Type of Tide: Diurnal/Semi-Diurnal _____
14. Navigation Traffic _____
15. Industrial Activity On or Near Source? _____
16. Describe Nearest Port _____

17. Potential for Pollution _____

18. Bottom Topography Near Inlet _____
19. Water Depth Near Potential Inlet _____

Freshwater Details at Site

1. Nearest River _____
2. Size of River _____
3. Other Sources of Freshwater _____

4. Rainy Season River Depth/Width _____
5. Dry Season River Depth/Width _____
6. Estimated Hydraulic Flow During Seasons _____

7. Potential for Flooding _____
8. Last Major Flood/Damage _____

9. Distance of Freshwater Source from Site _____
10. Potential for Well, Pipeline or Canal _____
11. Tidal Influence/Flux _____

12. Salinity at Potential Intakes (Low Tide) _____
13. Salinity at Potential Intakes (High Tide) _____
14. Potential Sources of Effluent _____

15. Pollution Potential _____

16. Agricultural/Farming Pollution _____

Meteorological Data at Site

1. Dry Season _____
2. Rainy Season _____
3. Temperature Variance: Wet Season _____ Dry Season _____

Flora and Fauna at Site

1. Describe the Marine Fisheries/Obtain Any Relevant Data _____

2. Distance to Broodstock Fishing Grounds _____
3. Typical Fishing Vessels _____

4. Nearest Fishing Port _____

Utilities/Resources at Site

1. Electrical Supply _____

2. Nearest Transformer _____
3. Type of Current _____
4. Capacity _____
5. Cost of Electricity _____
6. Potential for Power Shortages _____
7. Petroleum, Oil, Lubricant Availability _____

8. Building Materials _____

9. Equipment _____
- Laboratory _____
- Heavy Construction _____
- Computers _____

Socio/Economic Data at Site

1. Nearest City _____
2. Industries _____
3. Labor Force _____
4. Construction Contractors _____
5. Engineers _____
6. Aquaculturists _____
7. University/Research Backup _____
8. Business Education _____
9. Nearest Village/Town _____
10. Local Industries _____
11. Local Government _____
12. Political Peace and Tranquility/Unrest (in non-U.S. locales) _____
13. Other Aquaculture Projects (Hatcheries or Farms) in Area _____

14. Extent of Government Assistance _____

Design Criteria, Engineering and Construction

If one were to travel around the world examining and analyzing various hatchery operations, one of the first observations would be that all hatcheries are basically the same, in that there are certain areas within the overall complex that serve specific functions. The functions, when coordinated, constitute a production system that operates similarly to any factory. However, when hatcheries are compared at a more detailed level, they become very dissimilar. Design can be influenced by local tradition, the availability of certain building materials, desired production level, differences in culture of the species targeted for production, a particular approach to strategy and/or the physical site. In this section, some general statements are made about design that can be incorporated into developing any shrimp hatchery.

Preliminary Considerations

Selecting a suitable hatchery design should be one of the first steps in hatchery development and, for this reason, is closely tied to site selection.

The first question that usually comes up after site selection is how much capital outlay will be required for the project; however, this question cannot be answered unless some level of production has been identified. (In some cases the order is reversed, but let us assume that investment will be applied as needed.) For example, most hatcheries in Indonesia want to produce about one to two million postlarvae (PL15-20) per month. This is a relatively small hatchery compared to other hatcheries around the world, but nonetheless will serve as our subsequent model.

There are basically two hatchery designs currently used in Indonesia — a high stocking density model (intensive-type) and a low stocking density model (extensive-type). The high stocking density model is characterized by the following:

- Optimization of space
- Environmental control
- Dynamic water exchange
- System integration
- A continuous and coordinated production strategy
- High level filtration
- A higher level of automation

The basic intensive hatchery design modeled after the "ladder system," (Liao, 1984) was used for the Yayasan Dian Desa hatchery located in Jepara, Central Java. A quick glance at the design will show that all production facilities are contained within the same building.

The low stocking density design, however, is most common in Indonesia and reflects the following characteristics:

- Larger relative surface area based on lower stocking densities
- No accommodations made for environmental control
- Low or intermittent water exchange in culture tanks
- Batch production that is not necessarily coordinated with other systems
- Simple, low-level filtration
- Low-level of automation

Approach to Culture

Another factor impacting hatchery design relates to

the type of culture and culture techniques that will be used to produce nauplii, larval and postlarval shrimp, algae, *Artemia*, etc. For example, some hatchery operators prefer to add water to their larval-rearing tanks on a continuous basis. This implies the use of large outdoor or indoor algae culture tanks, an extensive distribution network of pipes, precision valves, a mixing manifold, etc. (Figure 17). The engineering is somewhat simpler for batch larval culture (Figure 16). In some areas of the world where the diurnal temperature variation can be quite extreme, the maturation facility must resort to the use of a heat exchanger or must recirculate its water through a large biological filtration system.

These are just some of the many examples of how a certain approach to culture can influence the engineering of a hatchery. Other examples are summarized below.

- Propagation of algal cultures as food within the larval rearing tank can determine roof design and length-to-width orientation of the hatchery itself.
- Use of microencapsulated diets can mean less space made available for algal and *Artemia* culture areas.
- The duration that shrimp stay in the hatchery can determine whether or not raceway tanks are used (some hatcheries keep postlarvae only until PL3-5 and, once harvested, they are transferred either directly to the growout pond or to a nursery pond).
- If algal species with a wide temperature tolerance are not used to feed larval shrimp, it may not be practical to include a large outdoor algae culture area.

These are only a few examples and may only be relevant to specific situations.

General Layout of the Hatchery

Most hatcheries are contained within one building or perhaps two (the nursery section sometimes is segregated to a separate building). Hatchery designs usually attempt to integrate all systems under one roof with the basic understanding that efficient use of space will lower the overall cost of the hatchery. Most designs centralize one important aspect of larval culture and orient other systems around this point. The most common strategy is to locate the larval culture area centrally and have supporting systems (algae culture, *Artemia* culture, feed preparation, maturation and postlarval culture, etc.) surrounding it. Noisy areas or supporting areas that need substantial interaction with the rest of the operation are situated as far as possible from the larviculture area (i.e., the generator room would not be located adjacent to the maturation area, the algae culture area would not be located between the larval rearing area and the postlarval rearing area, etc.). This approach attempts to eliminate the potential for cross-contamination, reduce unnecessary work, and maintain quiet in areas demanding quiet. The hatchery overview (Figure 6) is that of the Yayasan Dian Desa Hatchery (YDD)(Unit 1) in Jepara, Indonesia; Figure 20E shows the layout of a Central American hatchery. Both figures illustrate these points.

Modular Concept for Future Expansion

Many times hatcheries are designed to accommodate eventual expansion. Modular designs are helpful should a larger market for fry develop. They also lend themselves

to seasonal/traditional fluctuation in the market. The YDD hatchery typically experienced fluctuation in fry demand at the onset of the monsoon stocking season when production demand doubled. Hatcheries in the United States would experience similar demands during the spring and early summer months and demand would decrease during winter.

Culture Tanks

The size of the tanks used in hatcheries is determined by several factors. Many hatcheries size their tanks according to the single-spawn principal—that is, the larval-rearing tank can hold one average spawn of nauplii. The postlarval-rearing tank, in turn, can hold the average number of postlarvae surviving from that spawn. For example, if the average spawn from the maturation facility contains 400,000 viable nauplii (typical for *P. monodon*). If stocking is at a rate of 100 nauplii per liter in the larval rearing tank, this tank should contain 4,000 liters of water. If you usually experience 60 percent survival to the postlarval transfer stage, this means that 240,000 PL3 to PL5 will be transferred to the postlarval holding and rearing tank. Some postlarval-rearing tanks have been stocked to densities in excess of 5,000 PL3 to PL5 per square meter using habitats or screened barriers. A safer level would be somewhere around 2,000 per square meter, depending primarily on how long they will be kept before transfer to the pond and the ability to maintain proper water quality. If this stocking density is used, the postlarval-rearing tank needs a surface area of about 120 square meters. Again, this will vary according to expectations of survival, ability to stock at high densities, water exchange rate and quality of feed. A round

tank with a surface area of 120 square meters has a diameter of about 12.4 meters. A stocking rate of 4,000 per square meter requires a tank diameter of 6.2 meters.

The number of tanks used directly depends on the number of postlarvae to be produced each month. A project goal of 2 million postlarvae PL20 per month means only 4.5 million nauplii are required each month (75 percent survival from PL3 to PL20, 60 percent survival from N6 to PL2). This number of nauplii (4.5 million) means stocking about 11 larval-rearing tanks each month (400,000 per tank). Larval-rearing tanks should be started every two to three days. However, this does not mean 11 tanks are actually needed. With an average time of 13 days to PL3 and with a staggered approach to stocking, only six to seven larval-rearing tanks are required. More postlarval tanks are needed since they will be holding postlarvae for 17 days rather than 13 days (*P. monodon* sell at PL18 or 18-day-old PLs).

The variety of shapes and sizes of culture tanks, as well as materials used in construction, is extensive. It is necessary to classify them according to their function. The list below summarizes the variety of tank types and shapes currently used in hatcheries.

Sizing the Hatchery

Once a production level has been determined, the next step in design calls for proper sizing of tanks, estimating the number of tanks to be built, and the overall layout/dimensions of the building itself. According to Boucher (unpublished data, 1987), these determinations can and should be made with consideration given to a certain level of detail. A checklist of these criteria, as well as design calculations, are shown on worksheets 1 through 11.

List of Various Tanks Used in Hatchery Culture of Shrimp

Type	Material	Shape	Volume, MT or (sq. m)
Maturation	Ferrocement	Round	12
	Concrete	Round	12
	Plastic	Round	6
	Wood/plastic	Round	12
	Fiberglass	Round	9-12
	Concrete	Square	40
Spawning	Plastic trash can	Round	0.2
	Ferrocement	Round (Cylindro-conical)	0.7
	Fiberglass	Round	0.5
	Fiberglass	Square	0.5
	Asbestos	Rectangular	1.0
Larval (Figure 18)	Concrete	Cylindro-conical	2-20+
	Fiberglass	Cylindro-conical	2-5
	Ferrocement	Cylindro-conical	2-5
	Fiberglass	Half-barrel	5-15
	Ferrocement	Half-barrel	5-15
	Concrete	Rectangular	2-20
	Wooden, plastic	Rectangular	2-5
Postlarval	Fiberglass	Oval raceway	(15-100)
	Ferrocement	Round	(15-30)
	Buried, plastic	Rectangular	(50-100)
	Concrete greenhouse	Rectangular	(>200)
	Wooden, plastic	Square	(4-5)

Worksheet 1 - Postlarval (PL) Section Design

PostLarval Section Design Assumptions

Number of PLs required per month	= _____	PL/month
Proposed PL delivery schedule	= _____	days/tank
Initial stage of PLs when stocked	= _____	days
Final stage of PLs when delivered	= _____	days
Maximum density in PL tanks	= _____	PL/liter
Estimated PL survival rate	= _____	%
Average water depth in PL tanks	= _____	meters
Minimum freeboard in PL tanks	= _____	meters
Distance between individual PL tanks	= _____	meters
Distance between PL tank and exterior wall	= _____	meters

PostLarval Section Design Calculations

Duration in PL tanks	= _____	days
Minimum total PL tank volume	= _____	m ³
Minimum number of PLs tanks used	= _____	PL tanks
Actual number of PLs tanks used	= _____	PL tanks
Minimum diameter of individual PL tank	= _____	meters
Actual diameter of PL tank used	= _____	meters
Actual volume of individual PL tank	= _____	m ³ tank

Worksheet 2 - Larviculture (LC) Section Design

Larviculture Section Design Assumptions:

Duration of nauplii stocking period	= _____	days
Duration from nauplii to PL1 stage	= _____	days
Number of LC tanks to stock one PL tank	= _____	tanks/tank
Maximum density in LC tanks	= _____	PL/liter
Estimated LC survival rate	= _____	% PL/naup
Average water depth in LC tanks	= _____	meters
Minimum freeboard in LC tanks	= _____	meters
Distance between adjacent LC tanks	= _____	meters
Distance between LC tank and exterior wall	= _____	meters
Width of central walkway in LC section	= _____	meters

Larviculture Selection Design Calculations:

Duration in LC tanks	= _____	days
Number of nauplii required per day	= _____	naup/day
Minimum volume of individual LC tank	= _____	m ³
Minimum diameter of individual LC tank	= _____	meters
Actual diameter of LC tank used	= _____	meters
Actual volume of individual LC tank used	= _____	m ³
Minimum number of LC tanks	= _____	LC tanks
Actual number of LC tanks used	= _____	LC tanks

Worksheet 3 - Maturation (MT) Section Design

Maturation Section Design Assumptions:

Broodstock stocking density	= _____	adult/m ²
Females as a percentage of broodstock	= _____	% fem/adult
Expected nauplii production rate	= _____	naup/fem/mo
Diameter of one maturation tank	= _____	meter
Average water depth of maturation tank	= _____	meter
Expected duration of broodstock viability	= _____	weeks
Diameter of one spawning tank	= _____	meters
Average water depth of one SP tank	= _____	meters
Number of females per spawning (SP) tank	= _____	fem/tank
Distance between adjacent MT tanks	= _____	meters
Distance between MT tank and exterior wall	= _____	meters
Width of central walkway in MT section	= _____	meters

Maturation Section Design Calculations:

Total number of broodstock required	= _____	adults
Number of female broodstock	= _____	females
Number of male broodstock	= _____	males
Minimum number of MT tanks required	= _____	MT tanks
Actual number of MT tanks used	= _____	MT tanks
Volume of one MT tank	= _____	m ³
Broodstock replacement rate	= _____	adults/week
Volume of one spawning tank	= _____	m ³
Minimum number of SP tanks required	= _____	SP tanks
Actual number of SP tanks used	= _____	SP tanks

Worksheet 4 - Building Design

Building Design Assumptions:

Height of exterior walls	= _____	meters
Spacing of columns/trusses	= _____	meters
Thickness of floor slab	= _____	centimeters
Cross-sectional area of columns	= _____	m ²

Building Design Calculations:

Minimum length of larviculture section (next higher multiple of column spacing)	= _____	meters
Minimum length of maturation section (next higher multiple of column spacing)	= _____	meters
Length of center area	= _____	meters
Total length of main hatchery building	= _____	meters
Minimum width of larviculture section	= _____	meters
Width of main hatchery building (next higher multiple of column spacing)	= _____	meters
Width of postlarval shed	= _____	meters
Number of columns	= _____	columns
Total exterior wall area	= _____	m ²
Total interior wall area	= _____	m ²

Worksheet 5 - Pipe Sizing

Pipe Sizing Design Assumptions:

Water exchange rate in PL tanks	= _____	%/day
Water exchange rate in LC tanks	= _____	%/day
Water exchange rate in MT tanks	= _____	%/day
Desired filling time for PL tanks	= _____	hours
Desired filling time for LC tanks	= _____	hours
Number of secondary PL feeder pipes	= _____	pipes
Number of secondary LC feeder pipes	= _____	pipes
Number of secondary MT feeder pipes	= _____	pipes
Maximum velocity in pipes	= _____	test/sec
Estimated friction factor	= _____	
Equivalent length of PL supply pipe, fittings and gate valve	= _____	feet
Equivalent length of LC supply pipe, fittings and gate valve	= _____	feet
Equivalent length of MT supply pipe, fittings and gate valve	= _____	feet

Pipe Sizing Design Calculations:

Maximum flow rate to one PL tank	= _____	liters/sec
Average flow rate to one PL tank	= _____	f3/sec
Maximum flow rate to one LC tank	= _____	liters/sec
Average flow rate to one LC tank	= _____	f3/sec
Maximum flow rate to one MT tank	= _____	liters/sec
Average flow rate to one MT tank	= _____	f3/sec
Minimum diameter of each PL supply pipe	= _____	inches
Next larger pipe size	= _____	inches
Minimum diameter of each LC supply pipe	= _____	inches
Next larger pipe size	= _____	inches
Minimum diameter of each MT supply pipe	= _____	inches
Next larger pipe size	= _____	inches
Maximum flow rate of PL feeder pipes	= _____	liters/sec
Minimum flow rate of PL feeder pipes	= _____	f3/sec
Next larger pipe size	= _____	inches
Maximum flow rate of LC feeder pipes	= _____	liters/sec
	= _____	f3/sec
Total length of LC supply pipe	= _____	meters
Total length of LC feeder pipe	= _____	meters
Total length of LC mainline	= _____	meters
Total length of MT supply pipe	= _____	meters
Total length of MT feeder pipe	= _____	meters
Total length of MT mainline	= _____	meters

Worksheet 6 - Header Tank Sizing

Header Tank Design Assumptions:

Minimum detention time in header tank = _____ minutes

Minimum pressure of pipe at discharge = _____ psi

Header Tank Design Calculations:

Flow rate for PL tank water exchange = _____ m³/min

Flow rate for PL tank filling = _____ m³/min

Flow rate for LC tank water exchange = _____ m³/min

Flow rate for MT tank water exchange = _____ m³/min

Maximum total hatchery flowrate = _____ m³/min

Minimum volume of header tank = _____ m³

Actual volume of header tank used = _____ m³

Minimum elevation of header tank standpipe above hatchery floor = _____ feet

= _____ meters

NOTE: If it is desired to reduce the elevation of the header tank, try selectively using larger pipe sizes in one or more of the above applications.

Worksheet 7 - Seawater Reservoir (SR) Tank Sizing

Seawater Reservoir Design Assumptions:

Miscellaneous seawater usage = _____ m³/day

Average water depth on SR tank = _____ meters

Minimum freeboard in SR tank = _____ meters

Seawater Reservoir Design Calculations:

Water exchange requirements for PL tanks = _____ m³/day

Average number of PL tanks filled per day = _____ tanks/day

(rounded to next highest number) = _____ tanks/day

Filling requirements for PL tanks = _____ m³/day

Water exchange requirements for LC tanks = _____ m³/day

Average number of LC tanks filled per day = _____ tanks/day

(rounded to next highest number) = _____ tanks/day

Filling requirements for LC tanks = _____ m³/day

Water exchange requirements for MT tanks = _____ m³/day

Total volume of seawater reservoir = _____ m³/day

Worksheet 8 - Algae Culture

Algae Culture Design Assumptions:

Water exchange rate in LC tanks	= _____	%/day
Algae feeding density in LC tanks	= _____	cells/ml
Estimated ratio or larval algae consumption to natural algae production in LC tanks	= _____	cells/cell
Volume of algae mass-culture (AMC) tank	= _____	liters
Harvest cell density in AMC tanks	= _____	cells/cell
Minimum detention time in AMC tanks	= _____	days
No. of AMC tanks stocked/harvested per day	= _____	tanks/day
Volume of algae intermediate-culture (AIC) tank	= _____	liters
Harvest cell density in AIC tanks	= _____	cells/ml
Minimum detention time in AIC tanks	= _____	days
No. of AIC tanks stocked/harvested per day	= _____	tanks/day
Volume of algae carboy-culture (ACC) tank	= _____	liters
Harvest cell density in ACC tanks	= _____	cells/ml
Minimum detention time in ACC tanks	= _____	days
No. of ACC tanks stocked/harvested per day	= _____	tanks/day
Volume of algae flask-culture (AFC) tanks	= _____	liters
Harvest cell density in AFC tanks	= _____	cells/ml
Minimum detention time in AFC tanks	= _____	days
No. of AFC tanks stocked/harvested per day	= _____	tanks/day
Maximum water depth in algal culture area	= _____	meters

Algae Culture Design Calculations:

Total volume of AMC required	= _____	liters
Number of AMC tanks required	= _____	AMC tanks
Stocking cell density in AMC tanks	= _____	cells/ml
Total volume of AIC required	= _____	liters
Number of AIC tanks required	= _____	tanks
Stocking cell density in AIC tanks	= _____	cells/ml
Total volume of AIC required	= _____	liters
Number of AIC tanks required	= _____	AIC tanks
Stocking cell density in AIC tanks	= _____	cells/ml
Total volume of ACC required	= _____	liters
Number of ACC tanks required	= _____	ACC tanks
Stocked cell density in ACC tanks	= _____	cells/ml
Total volume of AFC required	= _____	liters
Number of AFC tanks required	= _____	AFC tanks

Worksheet 9 - *Artemia* Culture**Artemia Culture Design Assumptions:**

Duration from M1 to M2	= _____	days
Feeding density from M1 to M2	= _____	<i>Artemia</i> /ml
Duration from M3 to PL2	= _____	days
Feeding density from M3 to PL2	= _____	<i>Artemia</i> /ml
Duration from PL3 to harvest	= _____	days
Feeding density from PL3 to harvest	= _____	<i>Artemia</i> /ml
Expected hatching rate of <i>Artemia</i> cysts	= _____	<i>Artemia</i> /gm
Hydration density of <i>Artemia</i> cysts	= _____	gm/liter
Duration of hydration period	= _____	hours
Volume of <i>Artemi</i> hatching tank (AHT)	= _____	liters

Artemia Culture Design Calculations:

Expected number of LC tanks to be at M1-M2 stage on any given day	= _____	LC tanks
Number of <i>Artemia</i> needed from M1-M2	= _____	<i>Artemia</i> /day
Expected number of LC tanks to be at M3-PL2 stages on any given day	= _____	LC tanks
Number of <i>Artemia</i> needed from M3-PL2	= _____	<i>Artemia</i> /day
Expected number of LC tanks to be at PL3-harvest stage on any given day	= _____	LC tanks
Number of <i>Artemia</i> needed from PL-3-harvest	= _____	<i>Artemia</i> /day
Maximum number of <i>Artemia</i> needed per day	= _____	<i>Artemia</i> /day
Minimum amount of <i>Artemia</i> cysts to be hydrated per day	= _____	grams/day
Total volume of AHT required	= _____	liters
Minimum number of AHT tanks required	= _____	AHT tanks

Worksheet 10 - Aeration System

Aeration System Design Assumptions:

Aeration requirements for PL tanks	= _____	f ³ /min/m ³
Aeration requirements for LC tanks	= _____	f ³ /min/m ³
Aeration requirements for MT tanks	= _____	f ³ /min/m ³
Aeration requirements for SP tanks	= _____	f ³ /min/m ³
Aeration requirements for algal culture	= _____	f ³ /min/m ³
Aeration requirements for SR tank	= _____	f ³ /min/m ³
Number of diffusers per PL tank	= _____	dif/tank
Number of diffusers per LC tank	= _____	dif/tank
Number of diffusers per MT tank	= _____	dif/tank
Number of diffusers per SP tank	= _____	dif/tank
Number of diffusers for algal culture	= _____	diffusers
Pressure loss through diffuser	= _____	psi
Minimum air pressure at discharge	= _____	psi
Number of backup blowers per application	= _____	blowers

Aeration System Design Calculations:

Total airflow to PL section	= _____	f ³ /m
Total airflow to LC section	= _____	f ³ /m
Total airflow to MT section	= _____	f ³ /m
Total airflow to spawning tanks	= _____	f ³ /m
Total airflow to algal culture area	= _____	f ³ /m
Total pressure head in PL section	= _____	psi
Total pressure head in LC section	= _____	psi
Total pressure head in MT section	= _____	psi
Total pressure head to SP tanks	= _____	psi
Total pressure head to algal culture area	= _____	psi
Capacity of main hatchery blower	= _____	f ³ /m
Maximum pressure head of main hatchery blower	= _____	psi
Capacity of seawater reservoir blower	= _____	f ³ /m
Maximum pressure head of SR blower	= _____	psi
Total number of diffusers	= _____	diffusers
Length of air supply pipe/tubing	= _____	meters
Length of 3" pvc feeder pipe	= _____	meters
Length of 6" pvc air mainline	= _____	meters

Worksheet 11 - Shrimp Hatchery Design - Construction Cost Estimate

Item	Units	Quantity	Cost per Unit	Total
Clear and grade	m ²	_____	_____	_____
Excavation	m ³	_____	_____	_____
Rough grading	m ²	_____	_____	_____
Landscaping	m ²	_____	_____	_____
Footings	m ³	_____	_____	_____
Columns	m ³	_____	_____	_____
Concrete block wall	m ²	_____	_____	_____
Bond beam	m ³	_____	_____	_____
Top plate	LM	_____	_____	_____
Prefabricated trusses	EA	_____	_____	_____
Purlins	LM	_____	_____	_____
Corrugated roofing	m ²	_____	_____	_____
Exterior doors	EA	_____	_____	_____
Interior doors	EA	_____	_____	_____
Overhead doors	EA	_____	_____	_____
Postlarval tanks	EA	_____	_____	_____
Larviculture tanks	EA	_____	_____	_____
Maturation tanks	EA	_____	_____	_____
Spawning tanks	EA	_____	_____	_____
AMC tanks	EA	_____	_____	_____
AIC tanks	EA	_____	_____	_____
ACC tanks	EA	_____	_____	_____
AHT tanks	EA	_____	_____	_____
Header tanks	EA	_____	_____	_____
Seawater reservoir tanks	EA	_____	_____	_____
1" PVC pipe	LM	_____	_____	_____
1.5" PVC pipe	LM	_____	_____	_____
2" PVC pipe	LM	_____	_____	_____
3" PVC pipe	LM	_____	_____	_____
4" PVC pipe	LM	_____	_____	_____
6" PVC pipe	LM	_____	_____	_____
1" gate valves	EA	_____	_____	_____
1.5" gate valves	EA	_____	_____	_____
2" gate valves	EA	_____	_____	_____
3" gate valves	EA	_____	_____	_____
4" gate valves	EA	_____	_____	_____
5" gate valves	EA	_____	_____	_____
Concrete drainage channel	LM	_____	_____	_____
G.I. grating	SM	_____	_____	_____
Main seawater intake pumps	EA	_____	_____	_____
Secondary lift pumps	EA	_____	_____	_____
Main hatchery blowers	EA	_____	_____	_____
Seawater reservoir blowers	EA	_____	_____	_____
Water heating system	LS	_____	_____	_____
Electrical system	LS	_____	_____	_____
Lab supplies and equipment	LS	_____	_____	_____
Misc. supplies and equipment	LS	_____	_____	_____
SUBTOTAL		_____	_____	_____
15% Contingency		_____	_____	_____
TOTAL		_____	_____	_____

Note:

LM = Length in meters, EA = each, LS = Lump sum

Specific Hatchery Background

The following abstract appeared in the Journal of the World Aquaculture Society, Aquaculture Communiques (Volume 18, Number 1, page 20A, Communique number 72, 1987).

72. The Establishment of a Successful *Penaeus monodon* Hatchery in Jepara, Java.

TREECE, GRANVIL D., Texas Marine Advisory Service, Texas A&M University Sea Grant College Program, College Station, Texas 77843; FOX, JOE M., Central Java Enterprise Development Project, Gedung BAPPEDA, J1. Pemuda 127, Semarang, Indonesia.

A short-term technical assistance and information transfer subcontract between Development Alternatives, Inc., Washington, D.C., the United States Agency for International Development, the Central Java Enterprise Development Project and the Texas Agricultural Extension Service-Sea Grant Advisory Program resulted in the establishment of a successful *Penaeus monodon* hatchery in Jepara, Java. The hatchery is now operating as a "model" training facility for the country and is also producing an average of one million nauplii per day with only two maturation tanks in use.

Shortly after construction of the state-of-the-art hatchery was completed, an intensive technical information transfer was initiated. Broodstock was purchased from local fishermen, female shrimp were ablated and production began in less than one week. Twenty million nauplii were produced in the first 15 days and some of the broodstock had spawned three times in two weeks. After a production strategy was initiated, which took into consideration the hatchery's larval production needs, and a continuous scheme of production was established, the hatchery staff members were trained using techniques to sustain production. Three training sessions were conducted with neighboring hatcheries invited. Hatchery procedures were incorporated into a training program for future trainees by documenting activities specifically needed at that hatchery. The procedures were compiled into a training-operating manual, which can be used as a guide or tool in future training programs.

The successful establishment of this model hatchery should go a long way in assisting the development of a private sector hatchery capability in Java, using both formal and informal technology transfer methods.

The following two paragraphs are from the May 16, 1988, report of Development Alternatives, Inc., Yayasan Dian Desa, and the Central Java Enterprise Development Project.

Indonesian Hatchery Development Program

In Bandengan Jepara, there are two hatchery units referred to as Unit I and Unit II. Unit I is a model hatchery whose construction was partially funded by USAID and which has received most of the CJEDP program support for hatchery development. Unit II is also operated by Yayasan Dian Desa (YDD) and was built without USAID support, based on the design of Unit I. YDD thereby doubled its operational capacity and also doubled its facilities dedicated to the research and development of appropriate hatchery technology.

In general, both Unit I and Unit II have been performing as expected during the past quarter. Unit I was restarted after being temporarily shut down for cleaning. If the water quality holds into next quarter, it is hoped that the hatchery will achieve a combined output of 4 million postlarvae per month.

Unit I was constructed in 1986 by Yayasan Dian Desa for approximately \$90,000 (U.S.), and had an estimated production capacity of 3 million postlarvae per month. The hatchery is located on the island of Java in the Republic of Indonesia (see Figure 1). A recent NASA satellite survey has shown that Indonesia, also referred to as The East Indies, Malay Archipelago or The Spice Islands, is made up of nearly 20,000 tropical isles instead of the 13,677 isles which it was once thought to have. In the words of one writer, these isles "gird the Equator like a string of emeralds," and they comprise the most extraordinary collection of places, peoples, sights, tastes and natural wonders on earth. The model hatchery project of Yayasan Dian Desa is more specifically located on the north shore of Java near Bandengan Jepara (see Figure 2).

The basic layout and design of the hatchery was modeled after the "ladder system" described by Liao (1984), taking advantage of water levels and gravity. Even with "state-of-the-art" design, and a good location, success depends on good management practices. Management is the key to a successful hatchery operation, and it should be stressed that each hatchery will have its own procedures for optimum production.

Figures 3 through 20 give details of the hatchery, its seawater system, tanks and production areas, as well as tanks and systems used in other hatcheries.

Central American Facility (Hatchery Example)

Figures 20A through 20M depict a Central American hatchery that was designed to produce 10 million *P. vannamei* postlarvae per month.

There are many similarities between this hatchery design and the Indonesian one (Figures 1-20). The present day (1991) costs are given in Chapter 9, and represent half the costs of a fancier hatchery in Ecuador, which is also designed to produce 10 million PLs per month. The Indonesian hatchery, on the other hand, was built for half the cost of the Central American hatchery (approximately \$90,000.00 U. S.).

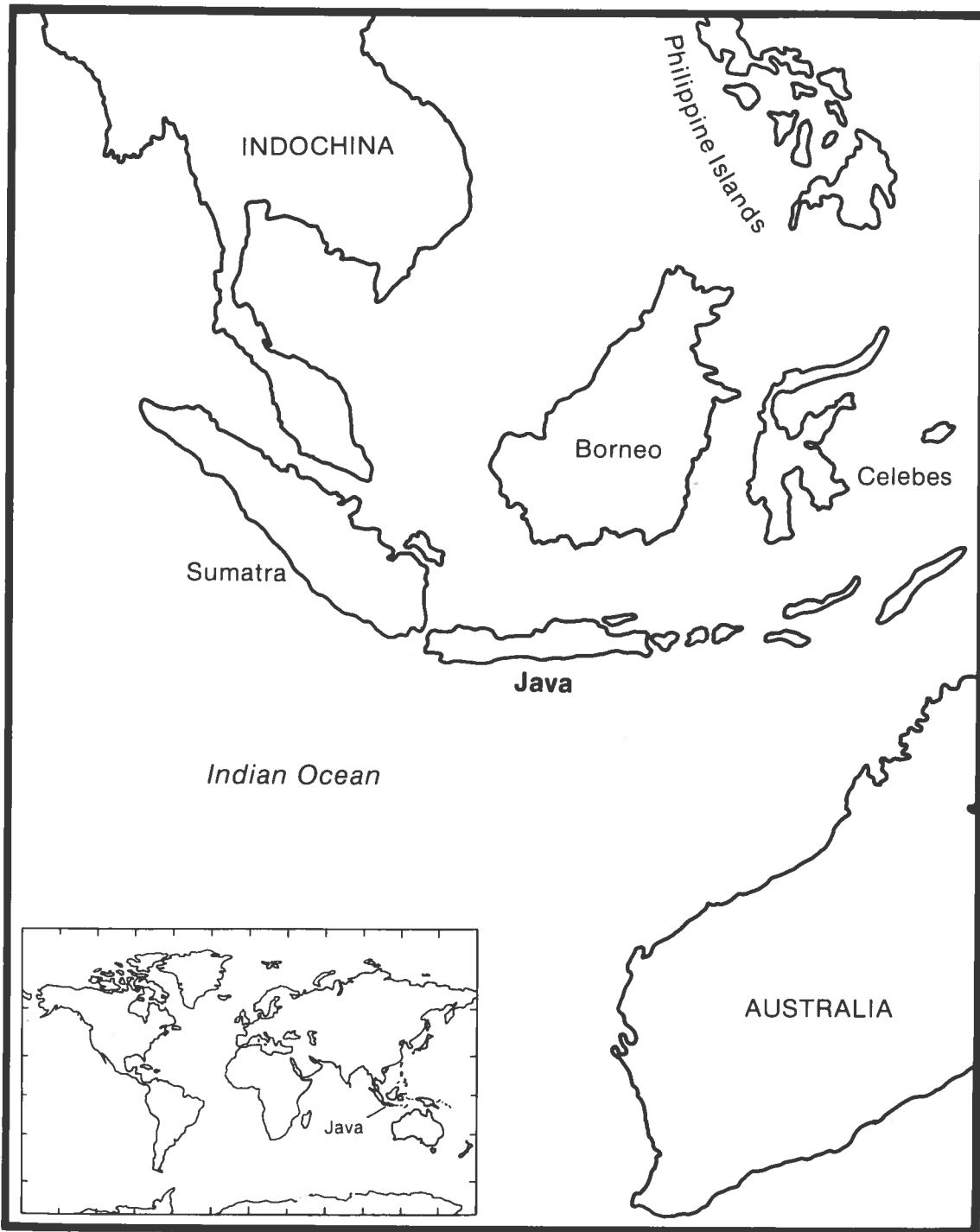

Figure 1. Location of Java

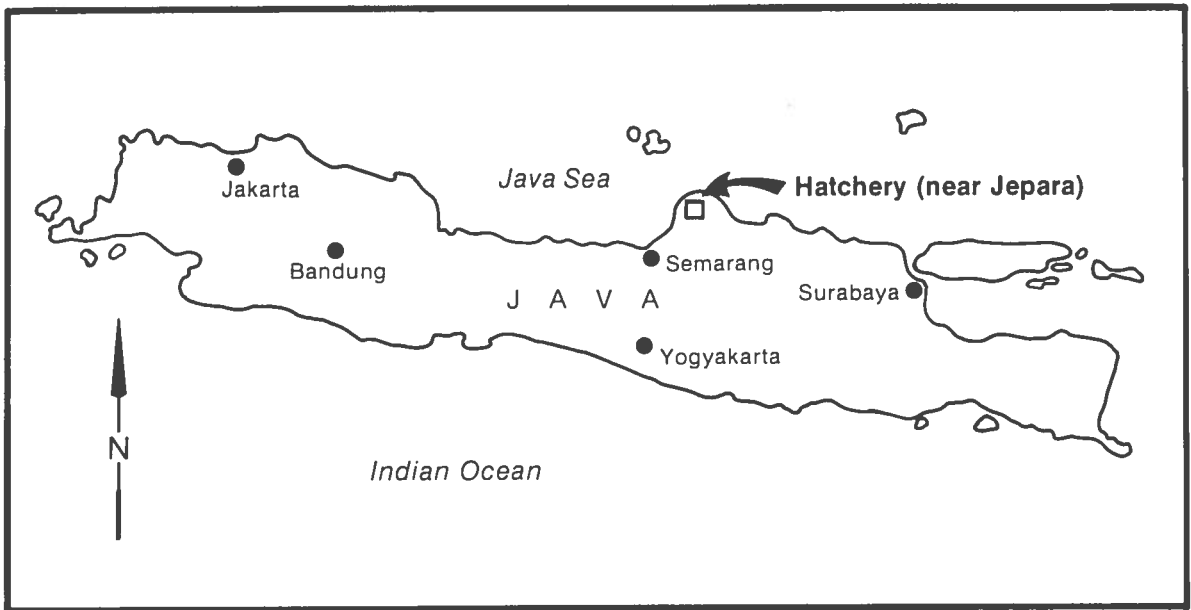

Figure 2. Location of Hatchery on Java

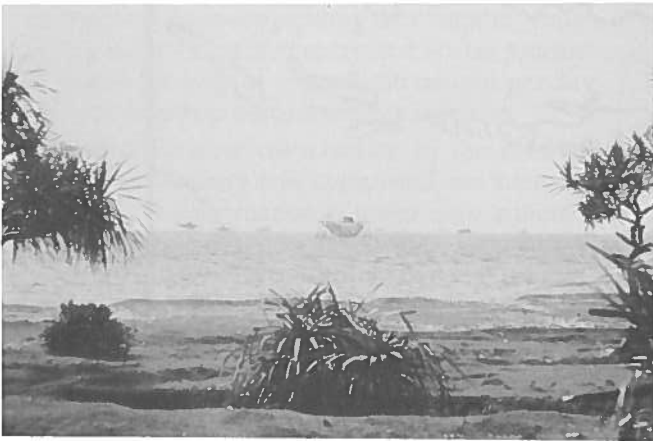

Photo 4. Bamboo fishing platforms offshore (nets are lowered at night with light above to attract catch).



Photo 5. Palm leaf barrier ("pound net" arrangement) with fisherman's platform at end where net is raised.



Photo 6. Fishing village located next to hatchery.



Photo 7. Proud fishermen who bring in broodstock shrimp when yellow flag is flying and hatchery is in need of new stock.

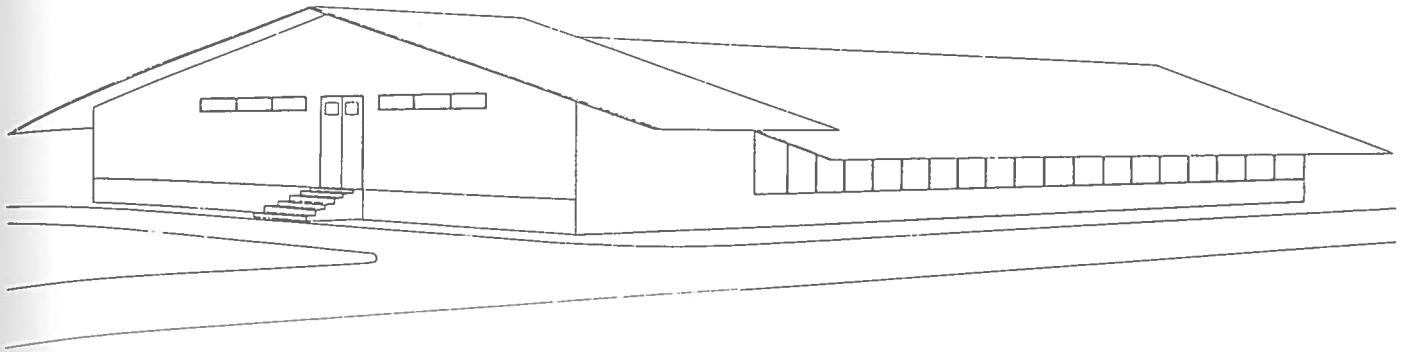

Figure 3. Dian Desa Hatchery



Photo 8. Dian Desa Hatchery front entrance..



Photo 9. Dian Desa Hatchery side view.



Photo 10. Maturation room (Unit II), lower left, generation or building, center; seawater settling, lower right.

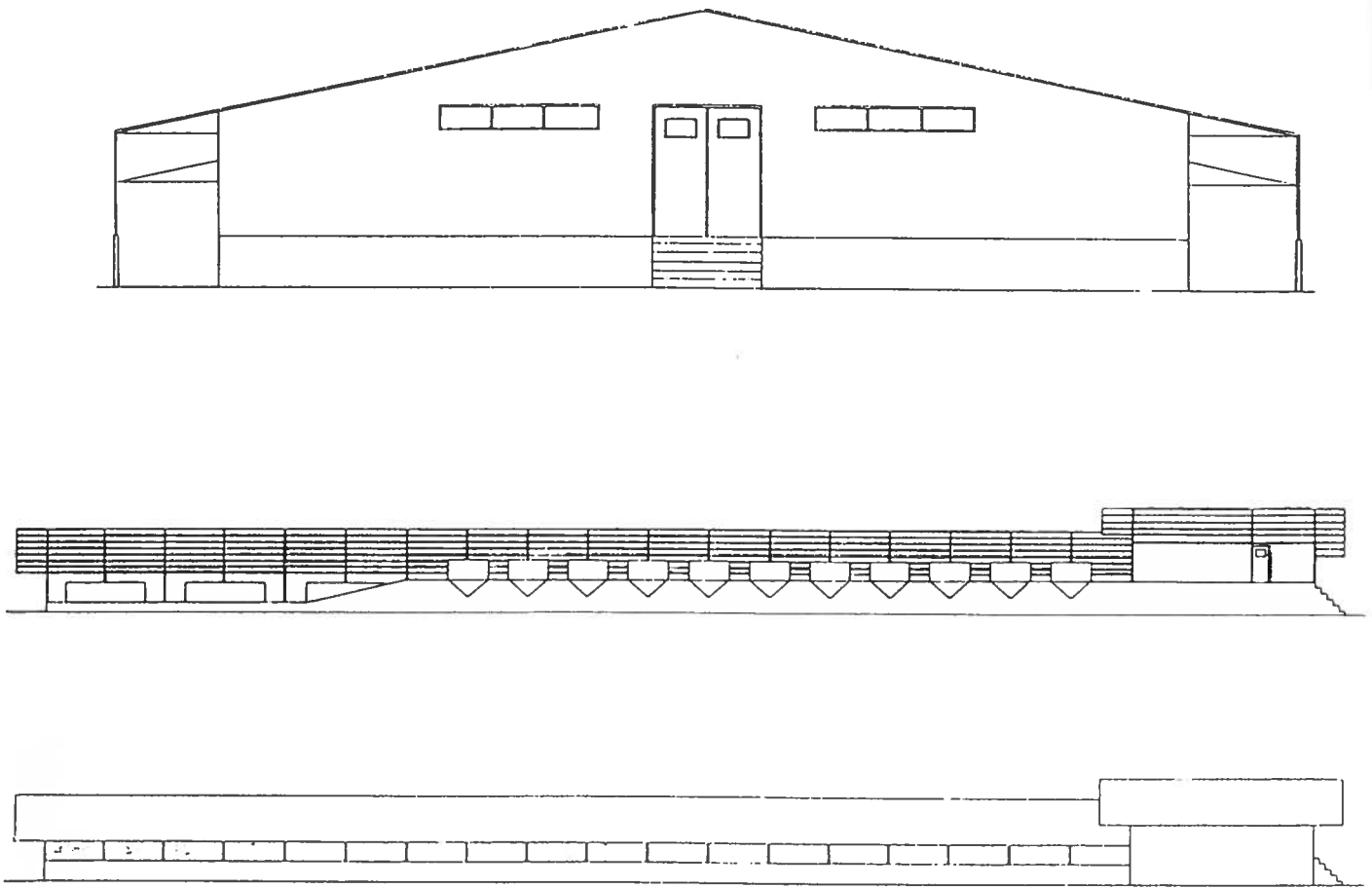

Figure 4. Front and Side View with Elevations

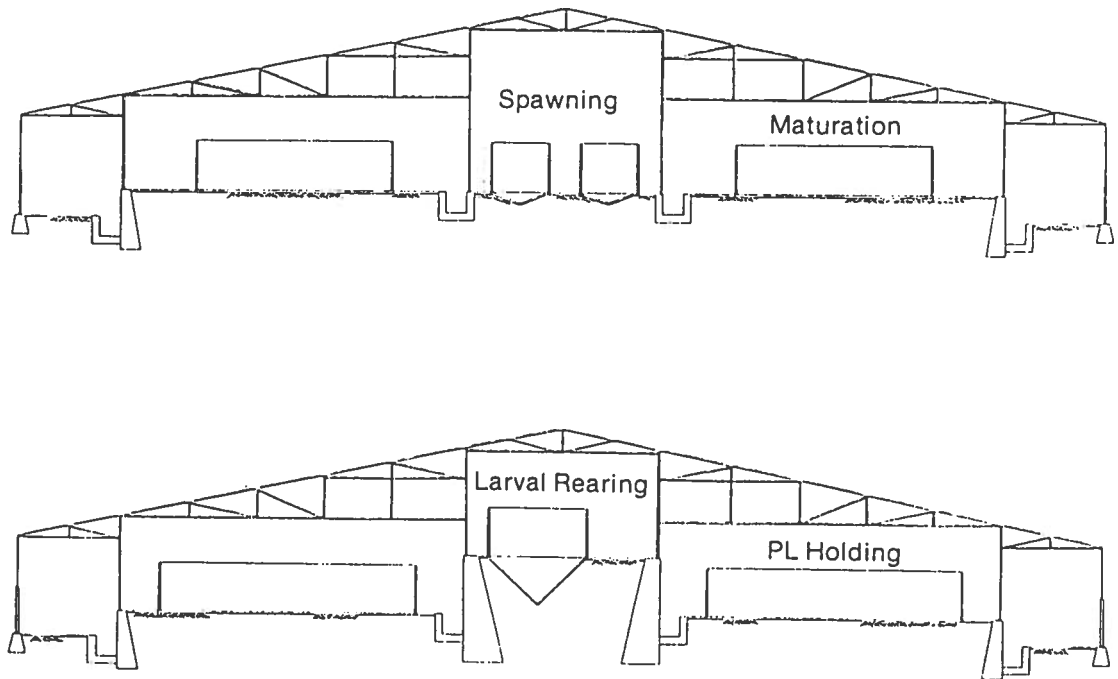

Figure 5. Front and Back View with Elevation

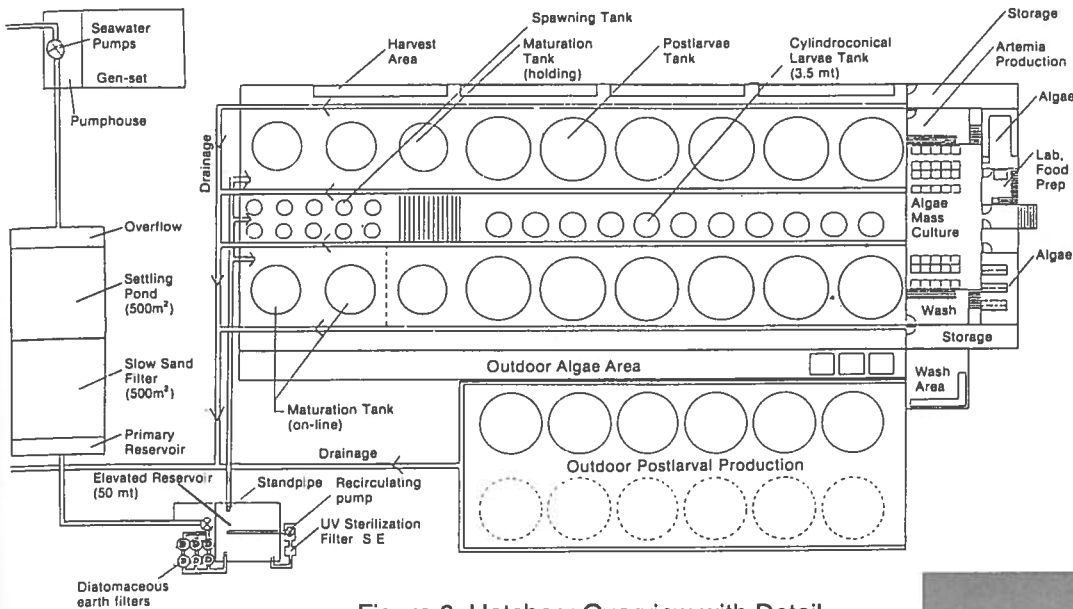

Figure 6. Hatchery Overview with Detail

Functional Areas within the Hatchery

System/Area	Description
Algae Culture (Figures 9 and 11)	Provides feed (algae) to the larval rearing tanks (LRTs). Shrimp larvae consume algae in their early stages.
Algae Laboratory (Figures 9 and 10)	Serves as a multi-purpose room for culture of small volumes of algae; counting; microscopic work; storage and weighing of chemicals, <i>Artemia</i> , artificial diets; washing of glassware.
Artemia Culture (Figure 8)	Provides <i>Artemia</i> nauplii for feeding to larvae in the LRTs. (Shrimp larvae consume <i>Artemia</i> in their latter stages.)
Larval Rearing (Figures 16-19)	Contains elevated conical tanks used for the culture of larvae. Postlarvae from here are transferred to postlarval rearing tanks or "raceways."
Postlarval Rearing (Figures 14 and 20)	Contains shallow cylindrical tanks used for production of postlarvae. From here PL 18 stage shrimp are transferred to growout ponds.
Maturation (Figures 12, 13 and 15)	Contains tanks used for maturing male and female shrimp so that they will mate in captivity. Mated females are transferred into spawning tanks where they release fertilized eggs (spawn). These eggs are allowed to hatch and the nauplii transferred to the LRTs.
Harvesting	Designed for harvesting postlarvae being transferred to pond for grow-out.
Aeration (Photos 11 and 12)	Used to provide air to the various production areas.
Seawater (Figures 7a and 7b)	Provides filtered seawater to all production areas.
Electrical (Photo 3)	Provides electricity for operation of pumps, air blowers, light banks, room lighting and air conditioning.



Photo 11. Air blower for Unit I Hatchery (high volume low pressure), later moved inside.

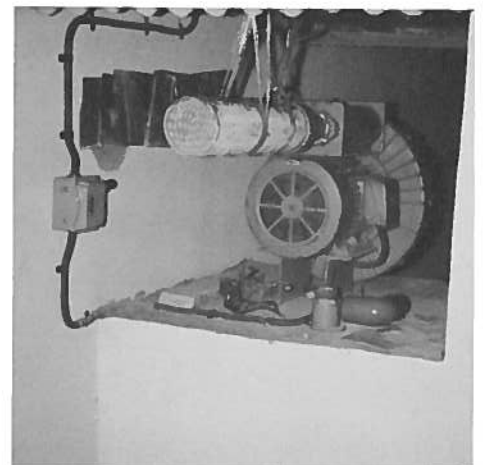

Photo 12. Close up of air blower and filtered intake.



Photo 13. Two Schedule 80 3-inch PVC Intake Pipelines (one intake in shallow water and one in deeper water).



Photo 14. Concrete holds Intake Pipes in place, visible at low tide.

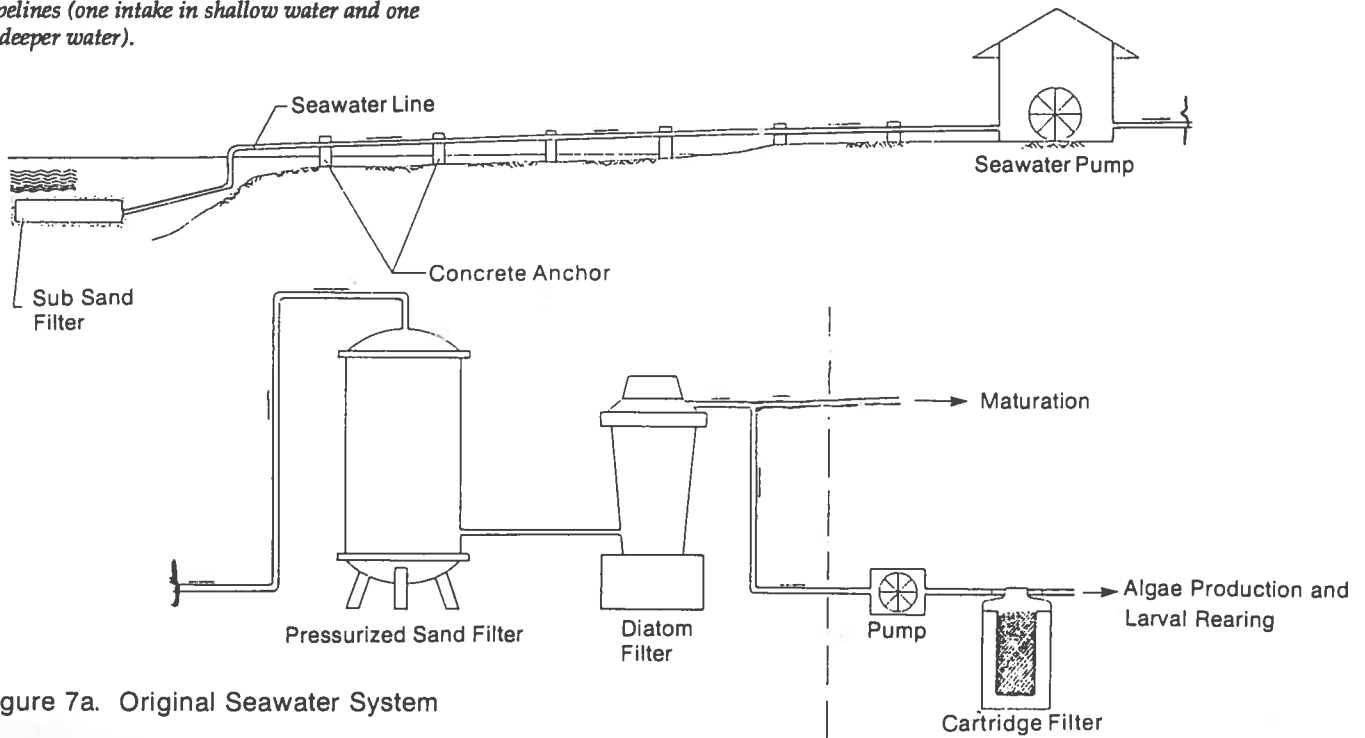

Figure 7a. Original Seawater System



Photo 15. Seawater pumps work on a demand system and use is rotated (only one runs at a time).

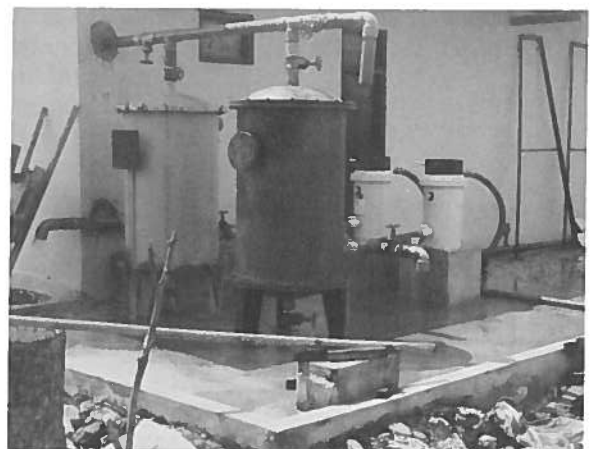

Photo 16. "Home-made" sand filters used in 1986, which were replaced by slow sand filters in 1987 (Photo 29).



Photo 17. Cement settling tank and cement slow sand filters, primary reservoirs and overflows.

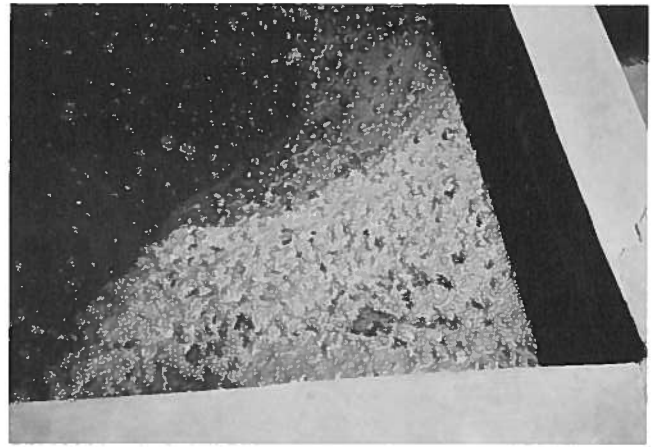

Photo 18. Primary Reservoir: Note organic matter floating and finished product (clear water).

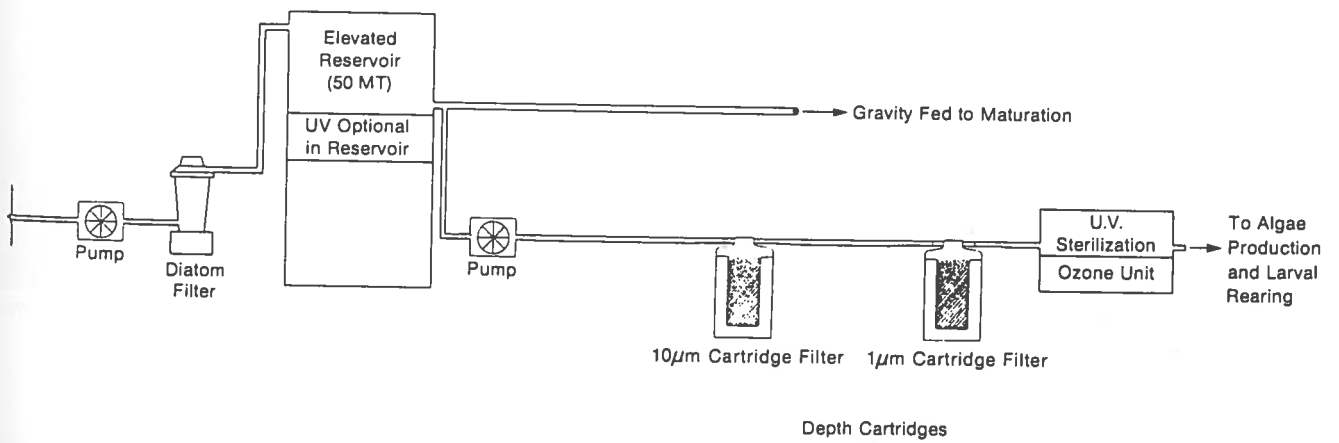
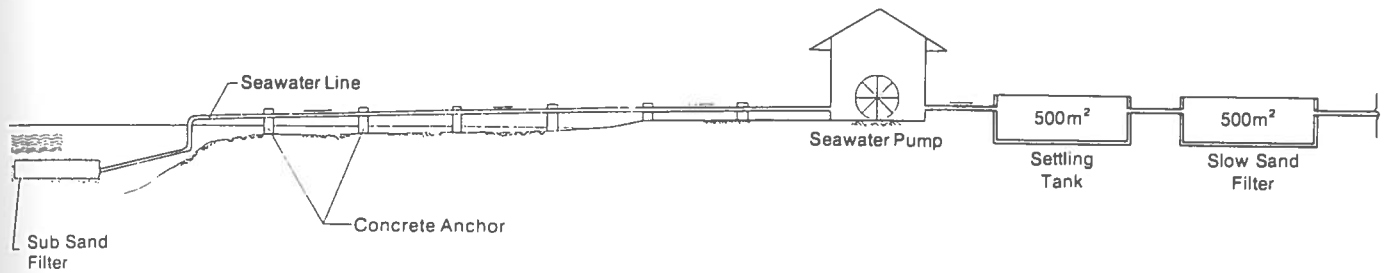

Figure 7b. Final Seawater System



Photo 19. Close up of primary, settling, slow sand and clean water in overflow.



Photo 20. Elevated reservoir (50 MT) acts as a constant head device for Unit I and Unit II (U.V. treatment takes place in head device reservoir and pumps, and D.E. filters are housed in structure below elevated reservoir).



Photo 21. Unit I, outside postlarval holding and rearing tanks, elevated reservoir.



Photo 22. Diatomaceous earth filters housed inside elevated reservoir structure.

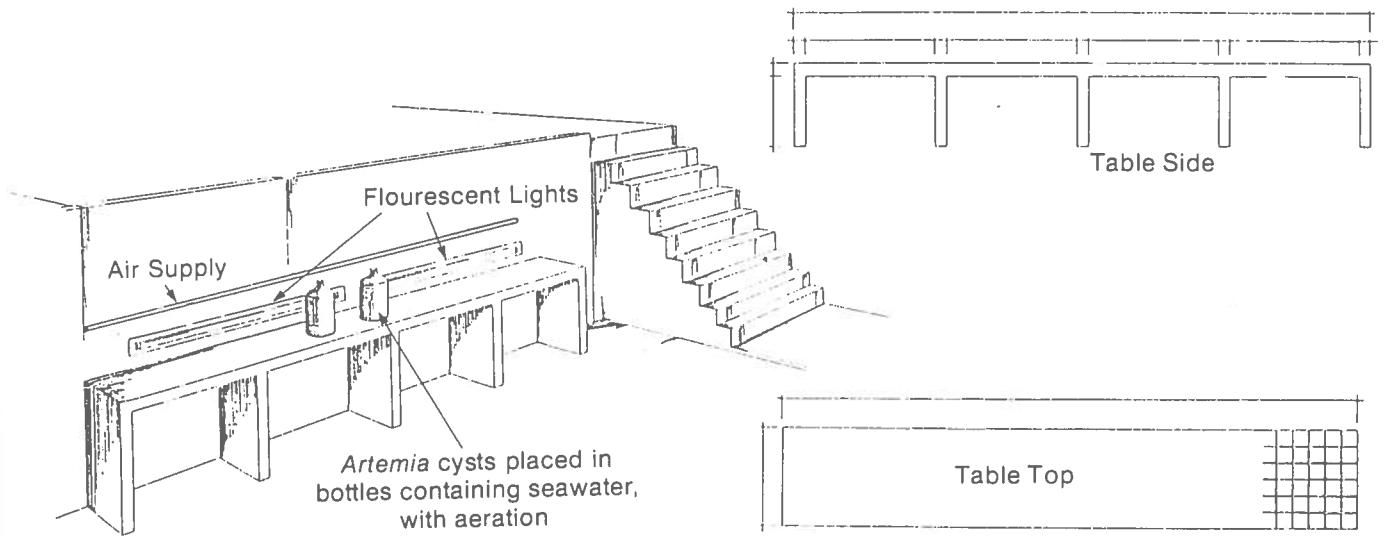

Figure 8. Artemia Production Area

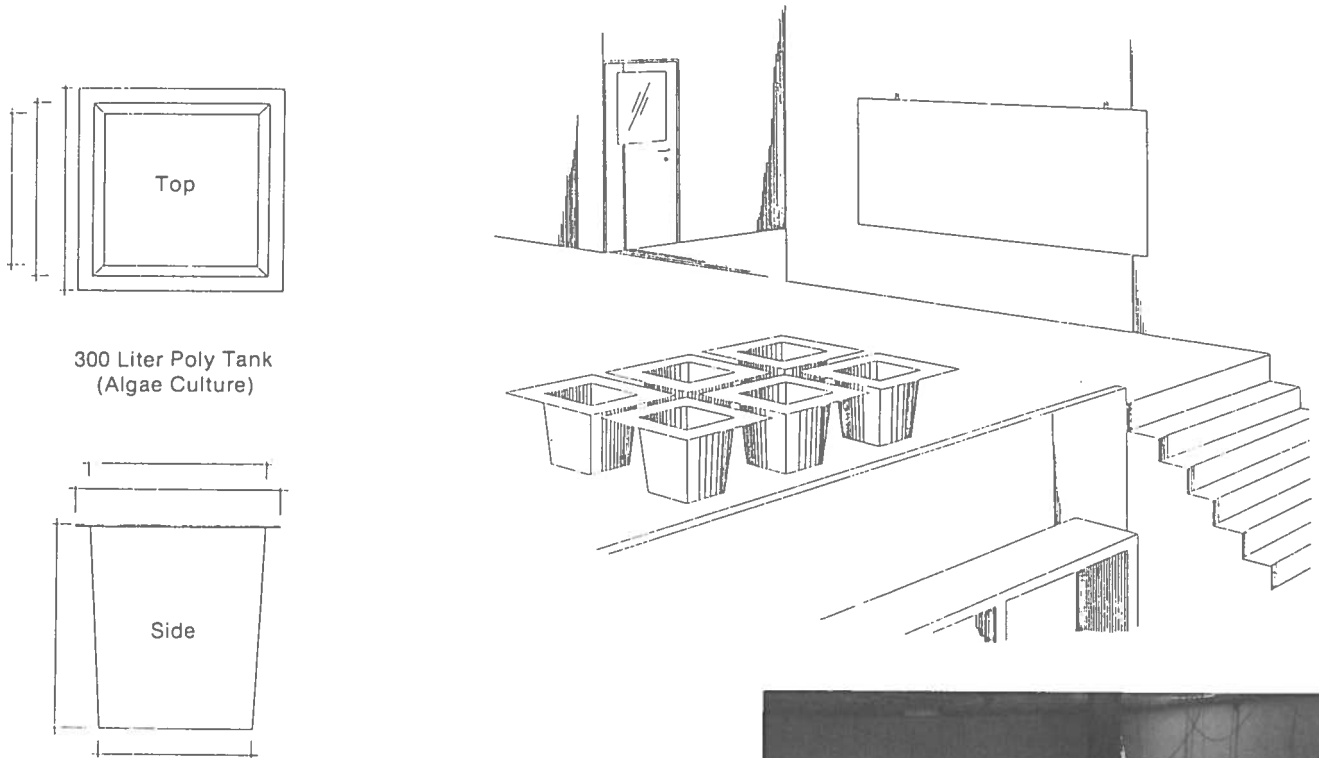

Figure 9. Laboratory and Algae Production in Fiberglass Polytanks



Photo 23. Algae production in 300-liter fiberglass tanks.

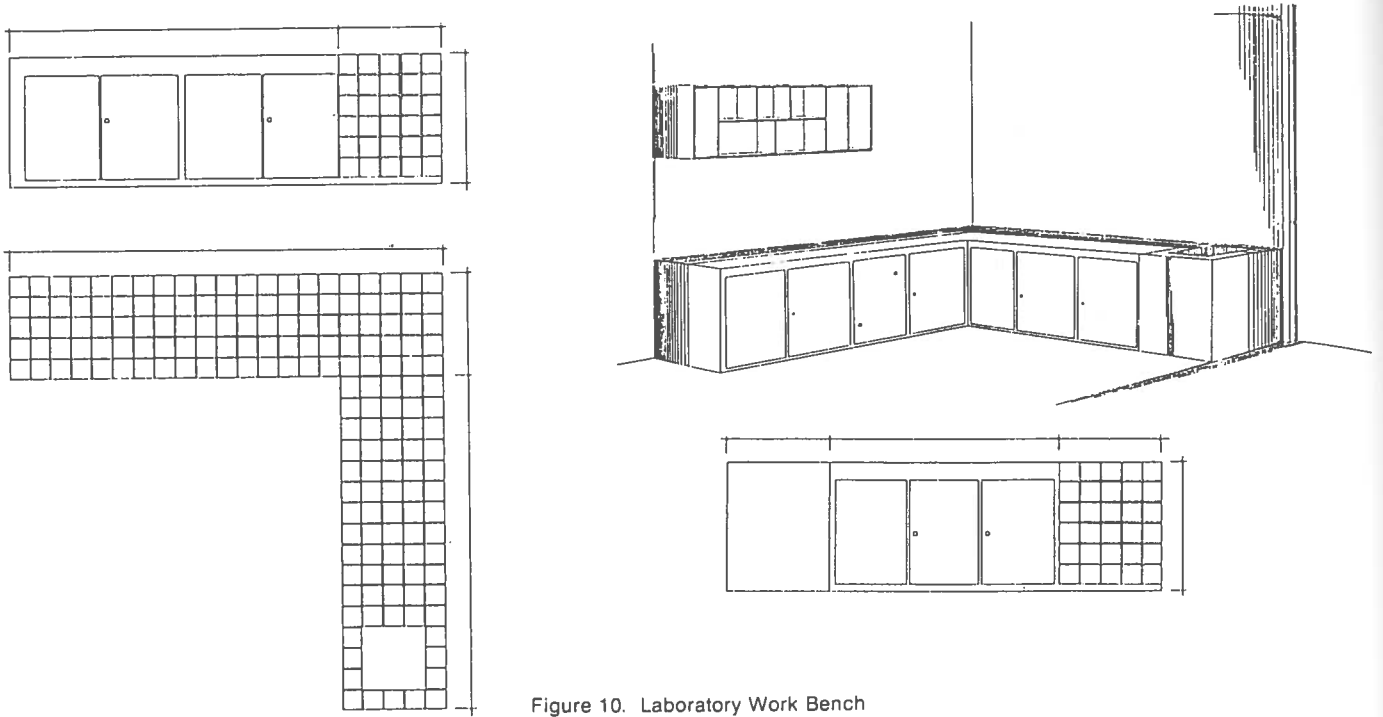

Figure 10. Laboratory Work Bench

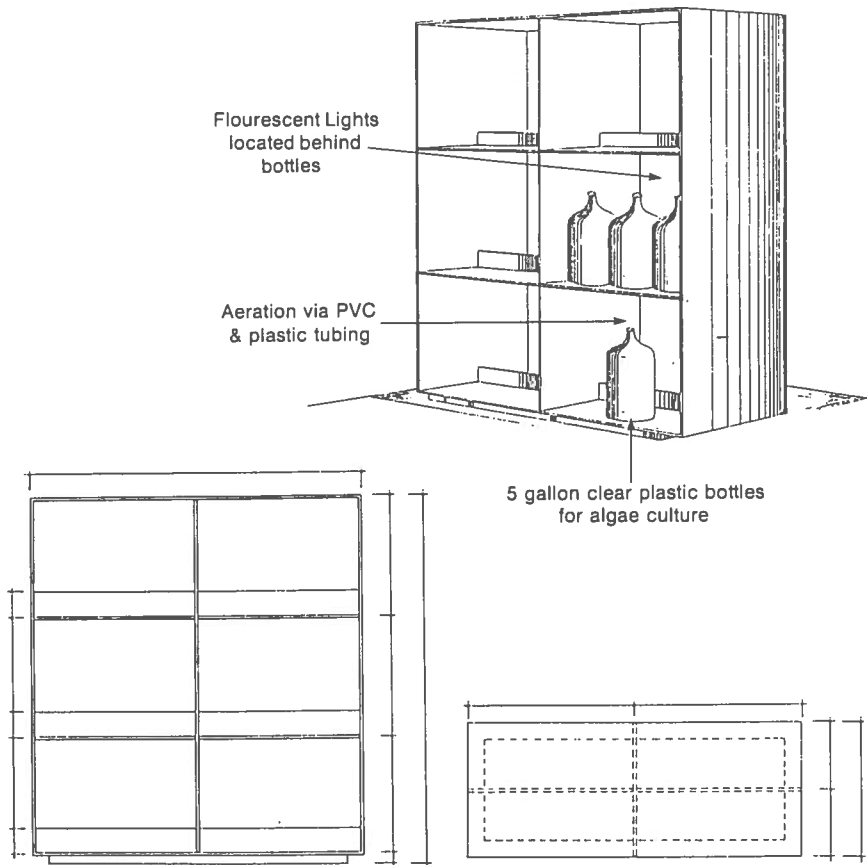
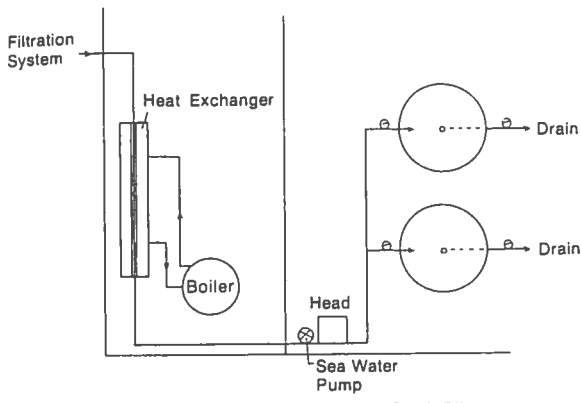

Figure 11. Carboy Stand for Algae Production



Photo 24. Algae production in 19-liter, or 5-gallon, clear plastic bottles (these are safer to handle and transport than the glass but are more difficult to clean).



Alternative 1: Open, Warm/Cool Climate

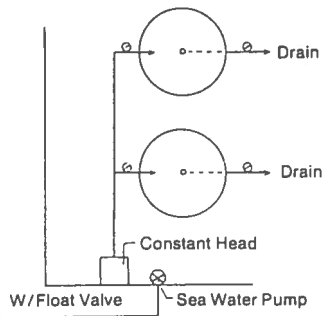

Alternative 3: Open, Warm Climate

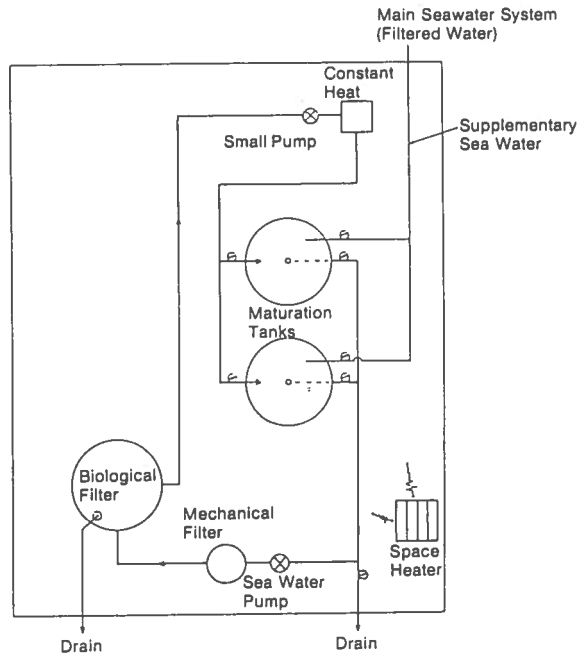

Alternative 2: Recirculating System

Figure 12. Various Maturation Systems (not drawn to scale)

⊗ - Valve

Figure 13. Maturation Tank Detail

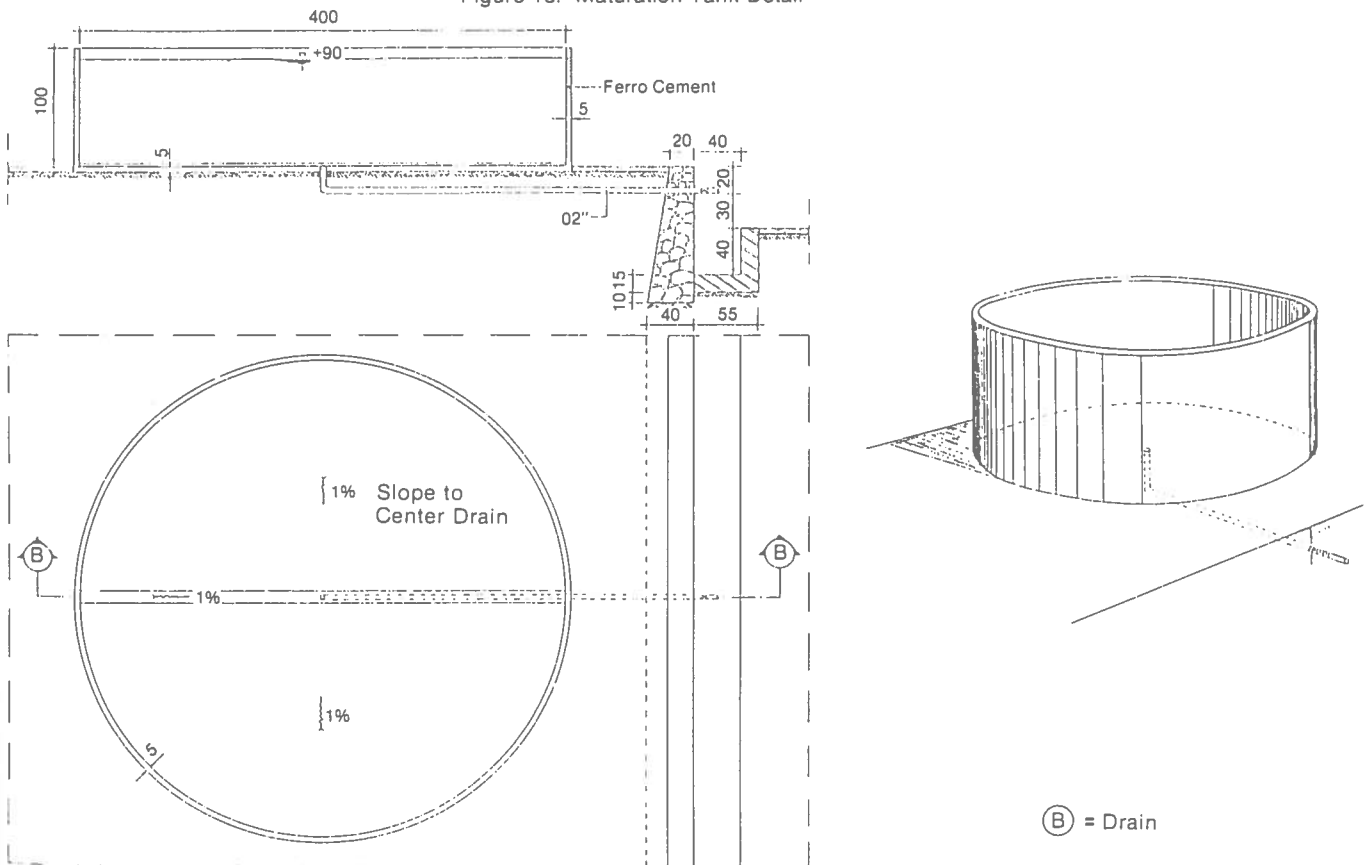

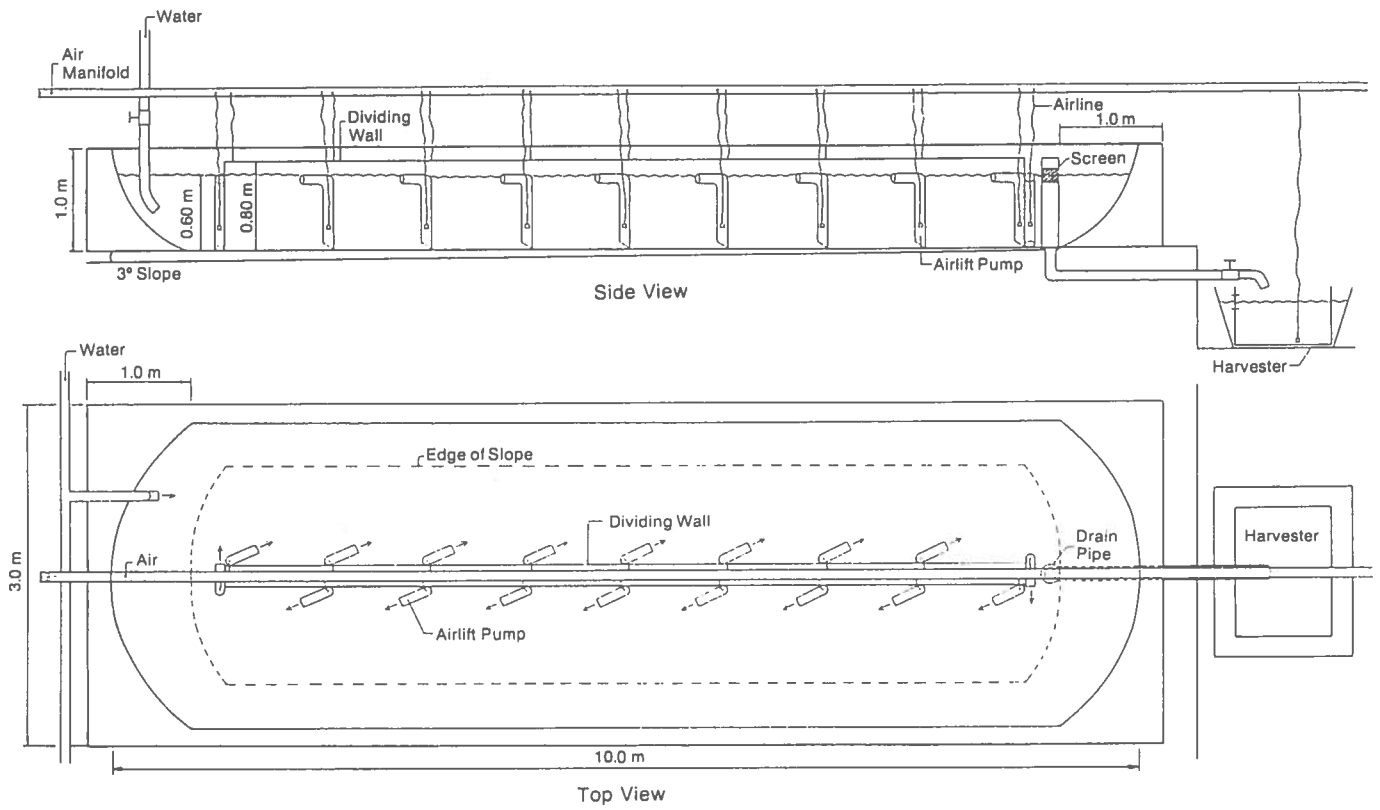

Figure 14. Typical Raceway Design (postlarvae)

Figure 15. Spawning Tank Detail

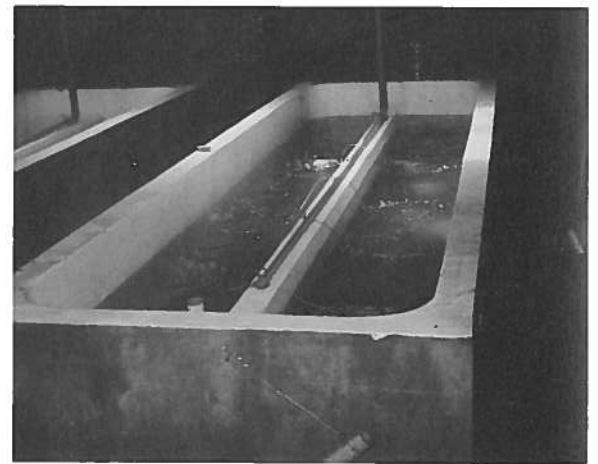
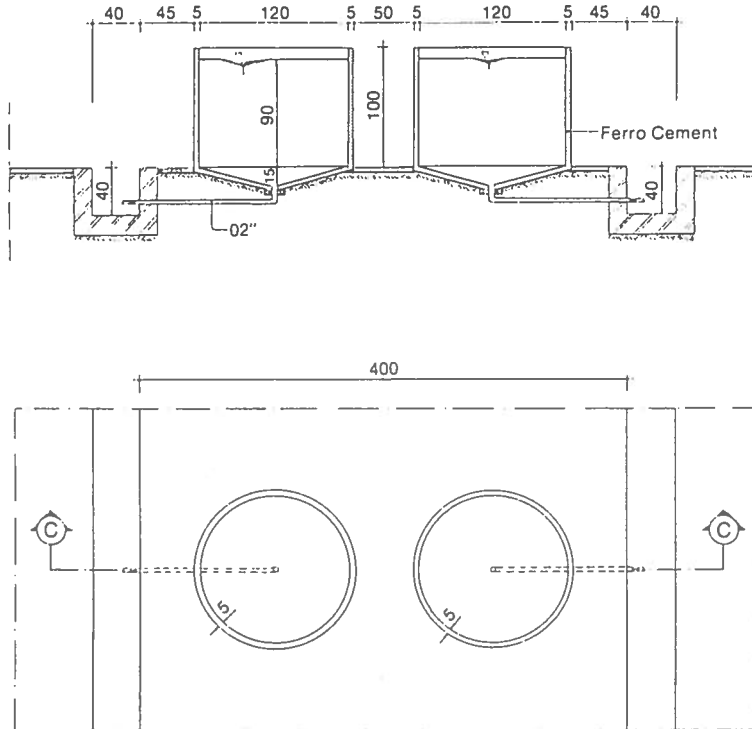
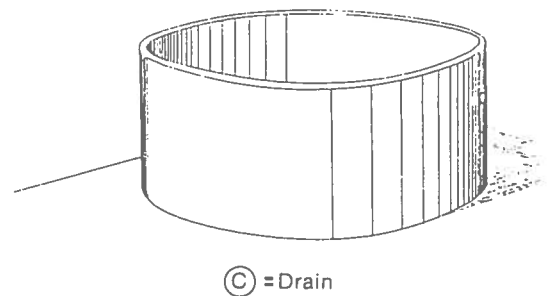
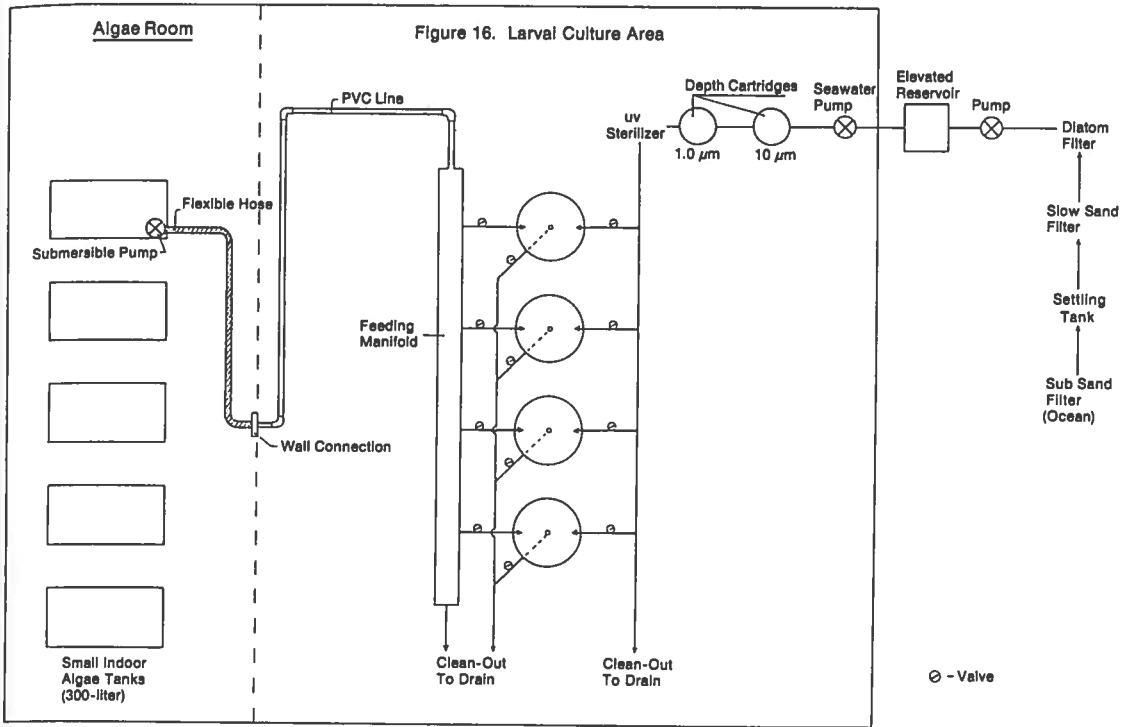

Photo 25. Rectangular larval rearing and postlarval rearing and holding tanks in use at nearby hatchery.



Ⓢ = Drain



Larval Rearing Approach 1 (batch feeding)

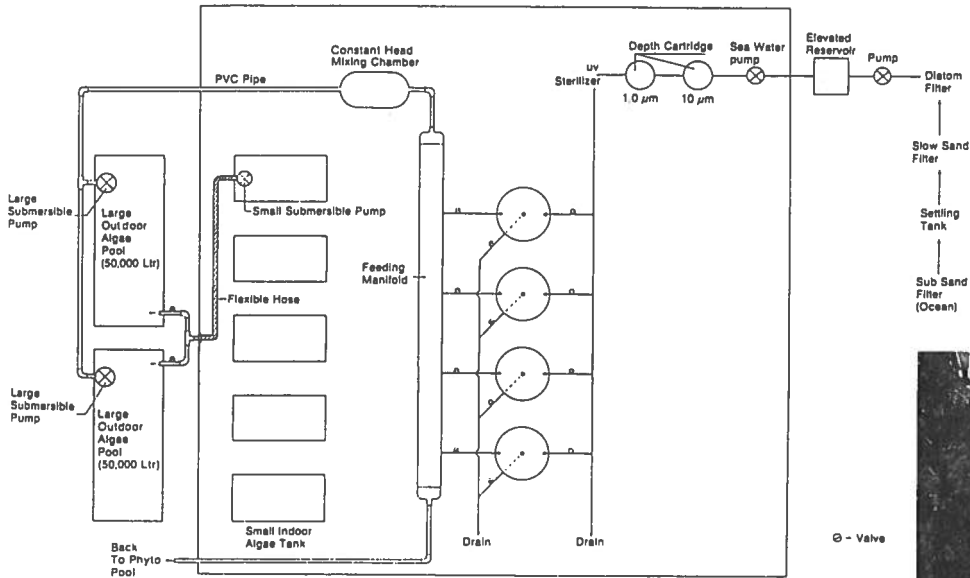
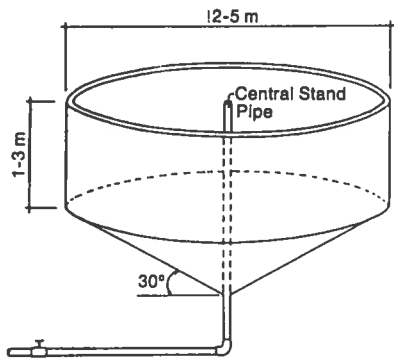

Figure 17. Larval Rearing Approach #2 (continuous feeding)



Photo 26. Hatchery effluent flow returning to ocean "downstream" of intake.



Cylindro-Conical

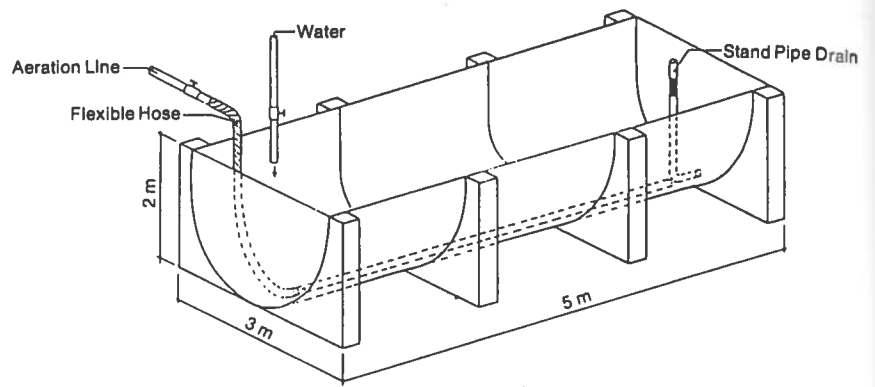

Half-Barrel Shape

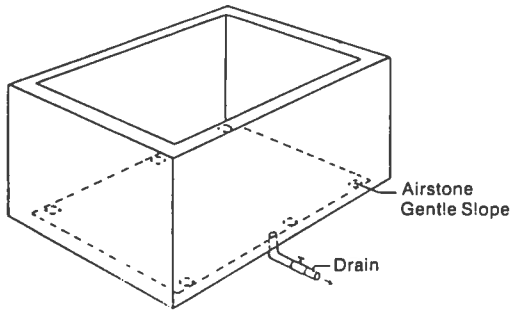

Square or Rectangular

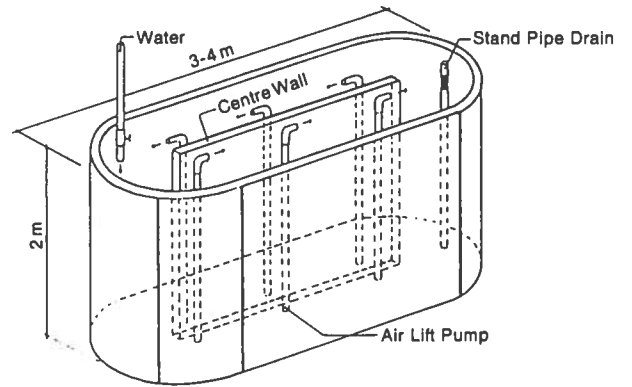

Larval Raceway

Figure 18. Various Larval Rearing Tanks

Figure 19. Larval Rearing Tank Detail

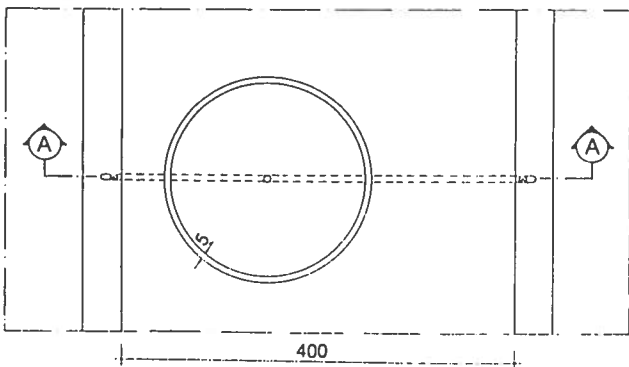
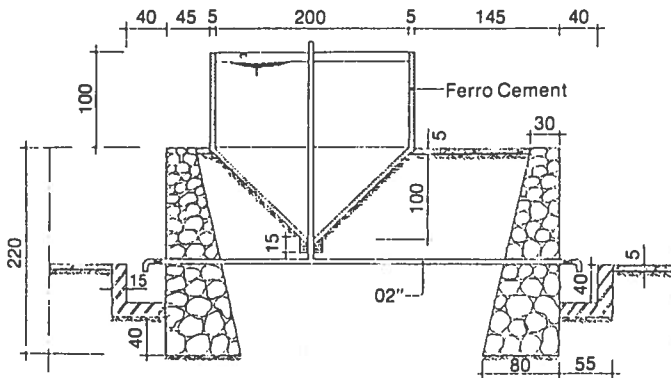

(A) = Drain

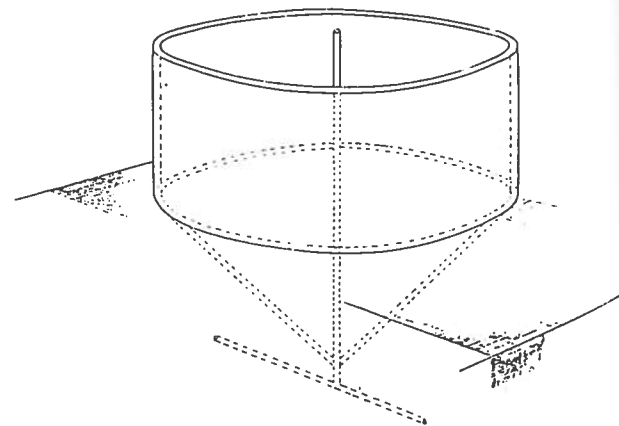

Figure 20. RaceWay Tank Detail

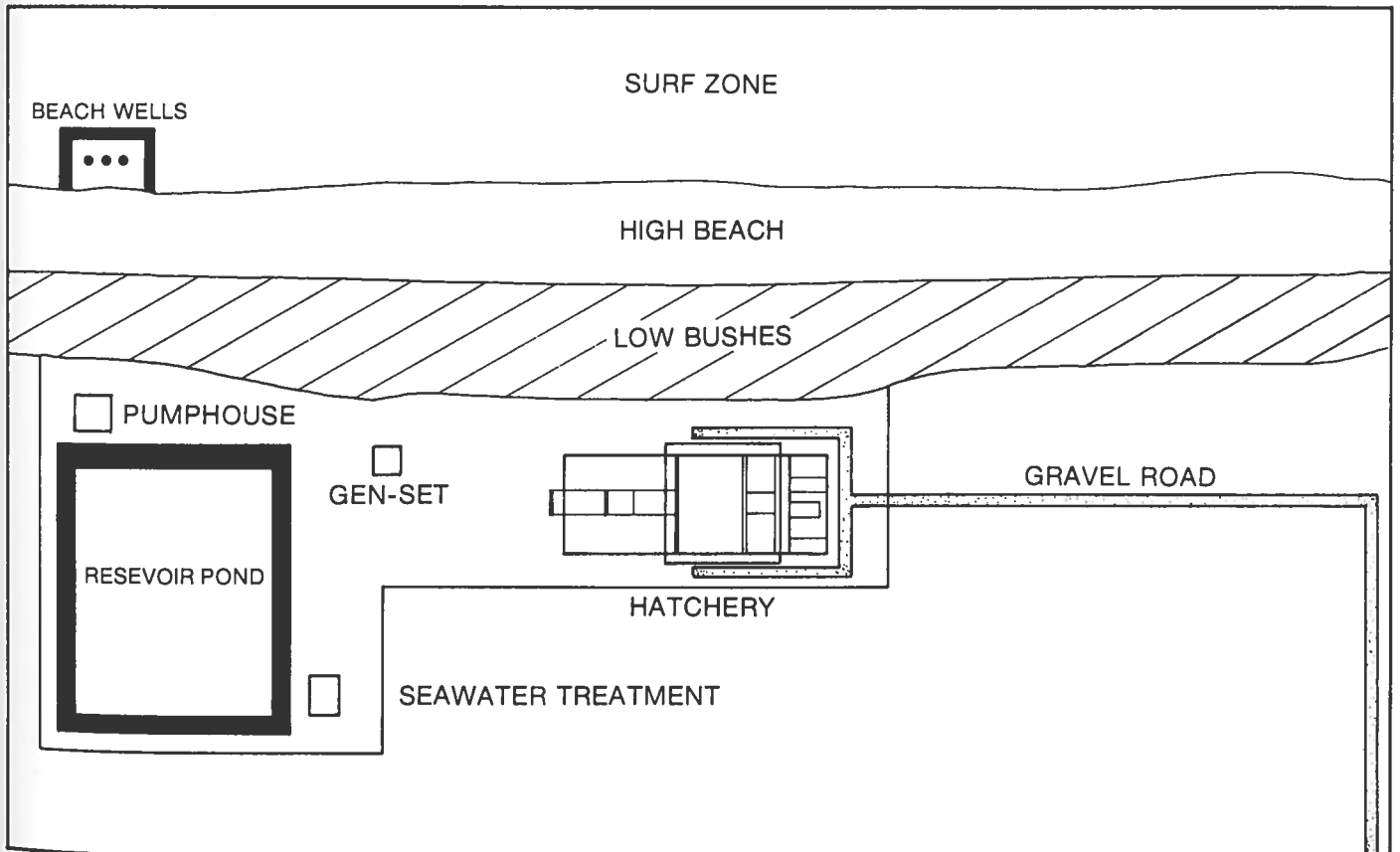
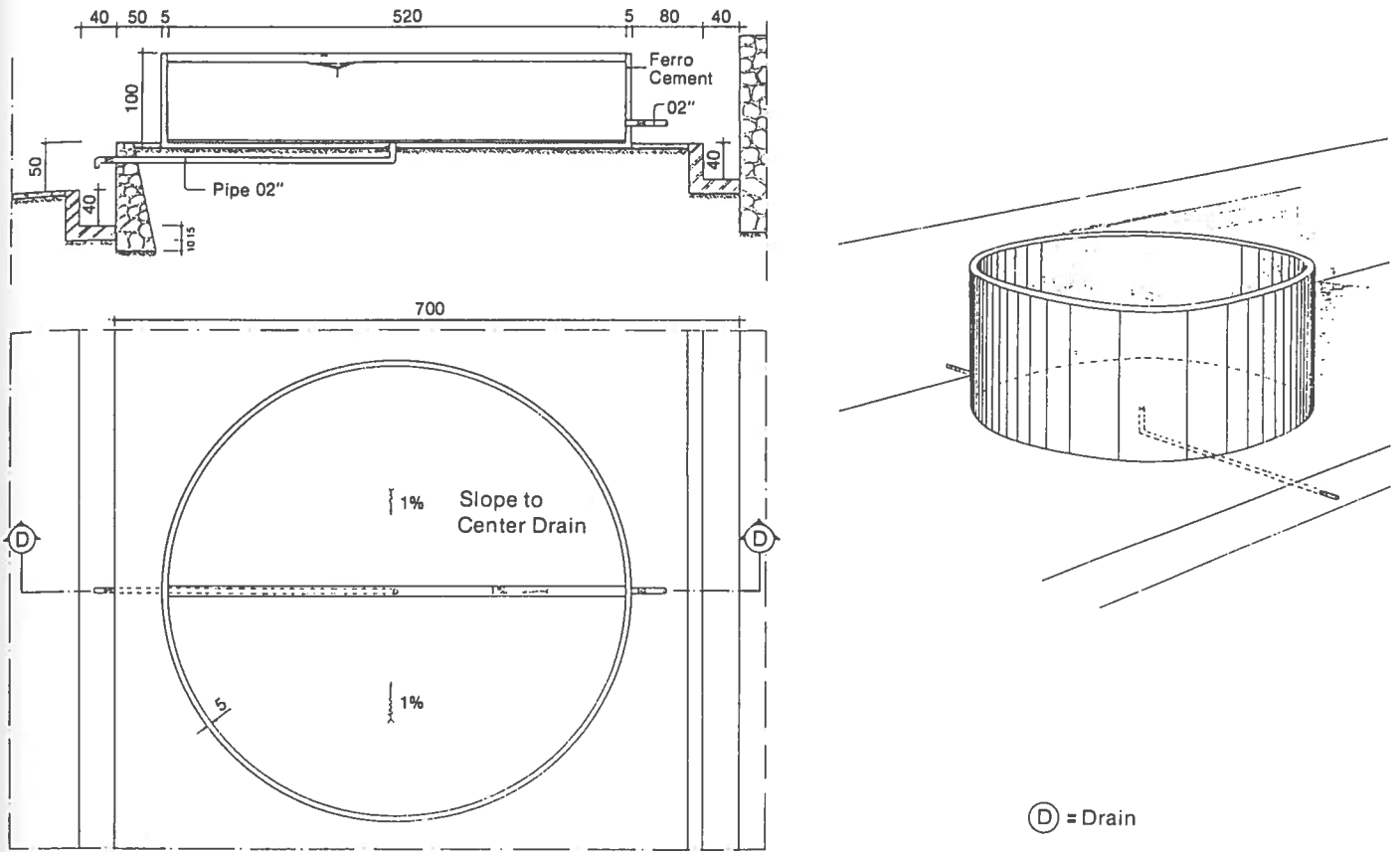

Figure 20A
CENTRAL AMERICAN HATCHERY FACILITY

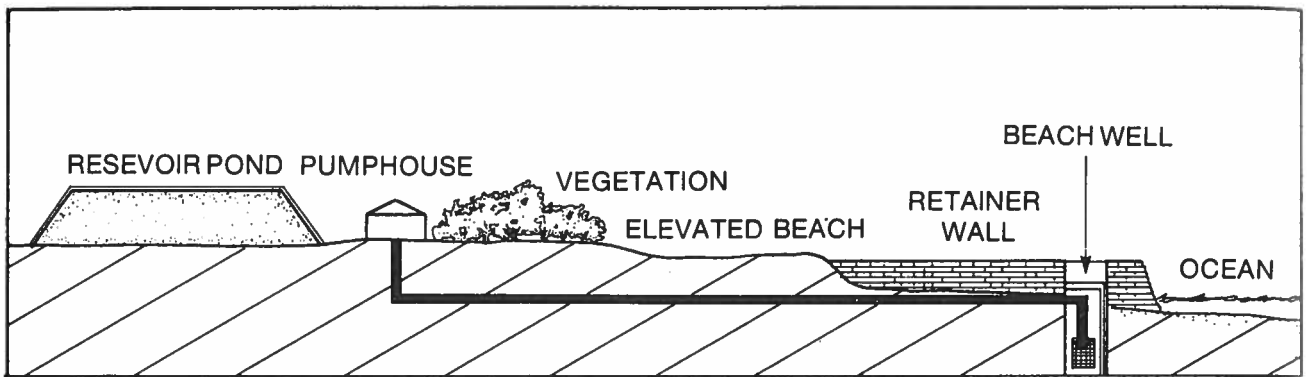

Figure 20B

CONCEPTUAL DRAWING OF SEAWATER INTAKE
CENTRAL AMERICAN FACILITY

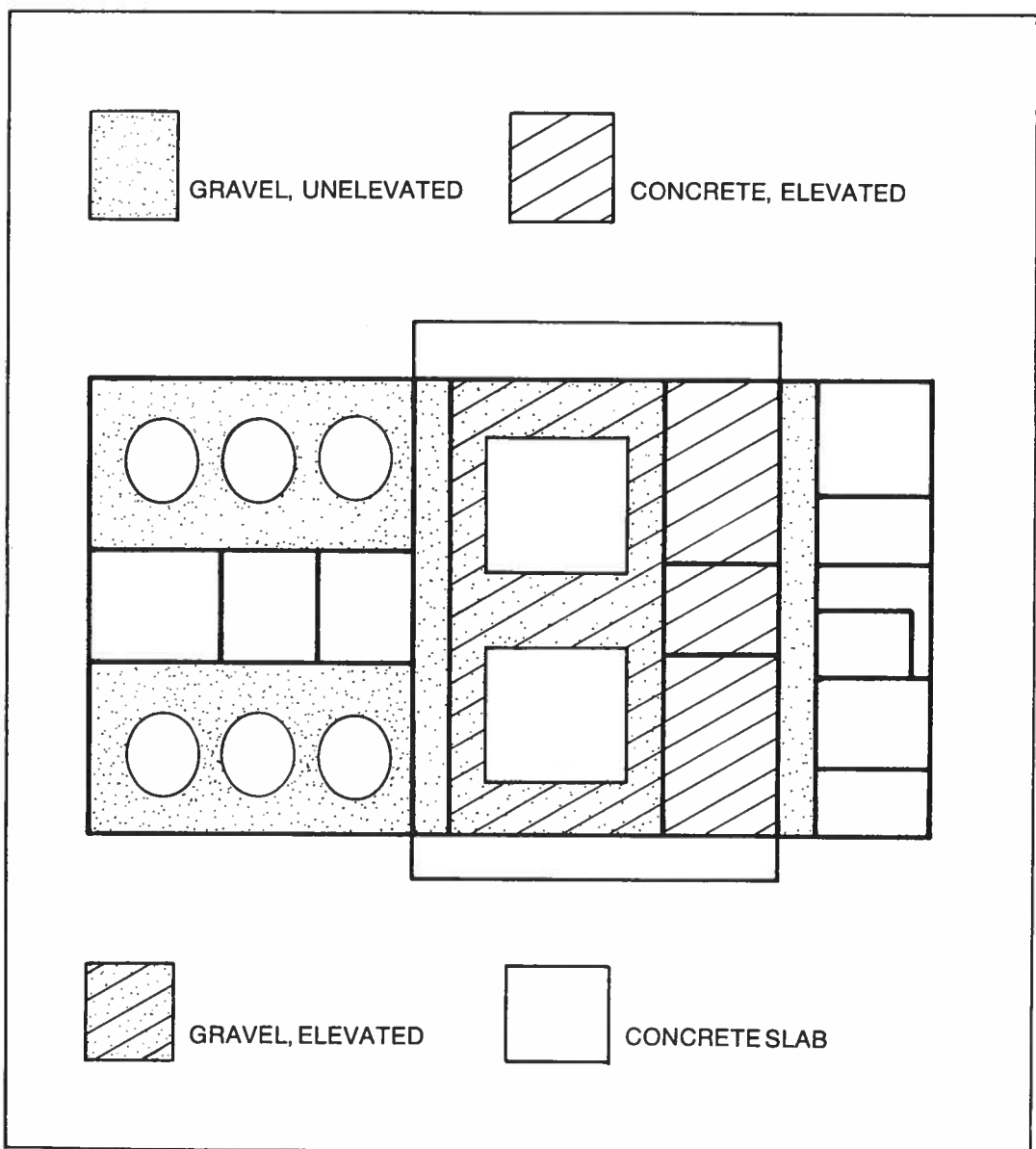

Figure 20C

CENTRAL AMERICAN
HATCHERY FOUNDATION /LEVELS

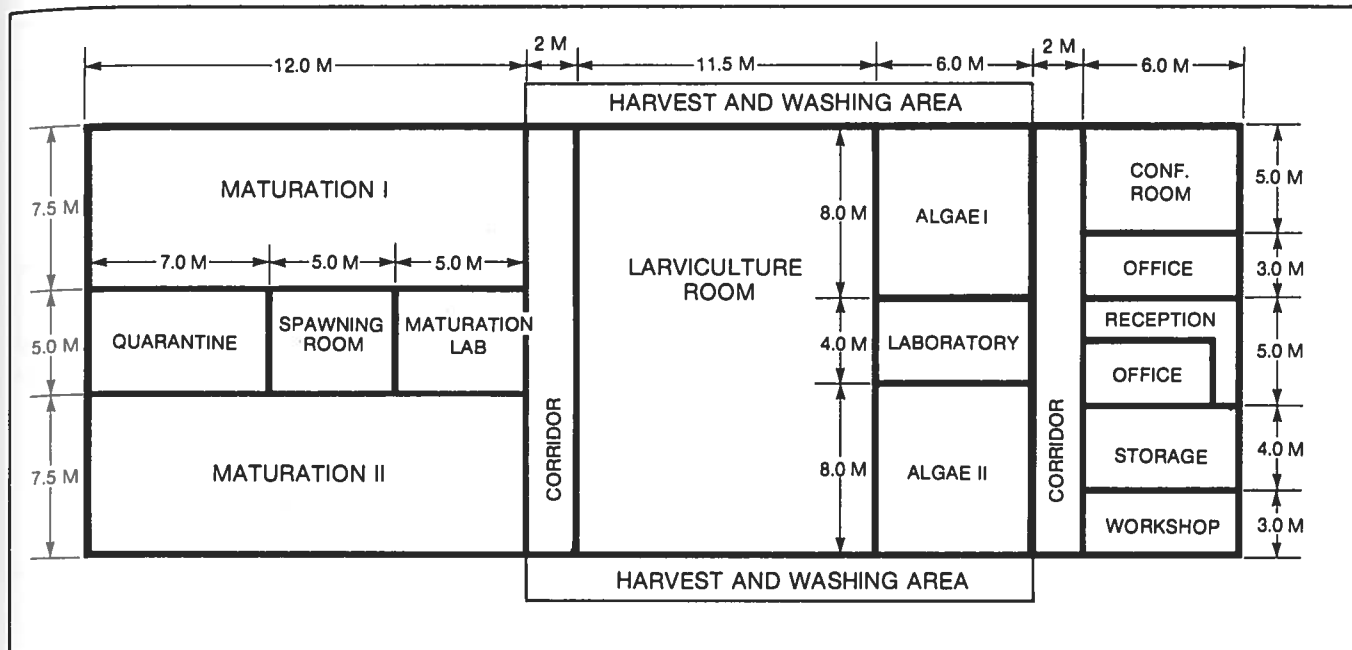

Figure 20D
**CENTRAL AMERICAN HATCHERY
 ROOMS AND DIMENSIONING**
 (10 Million PL/Mo. Production)

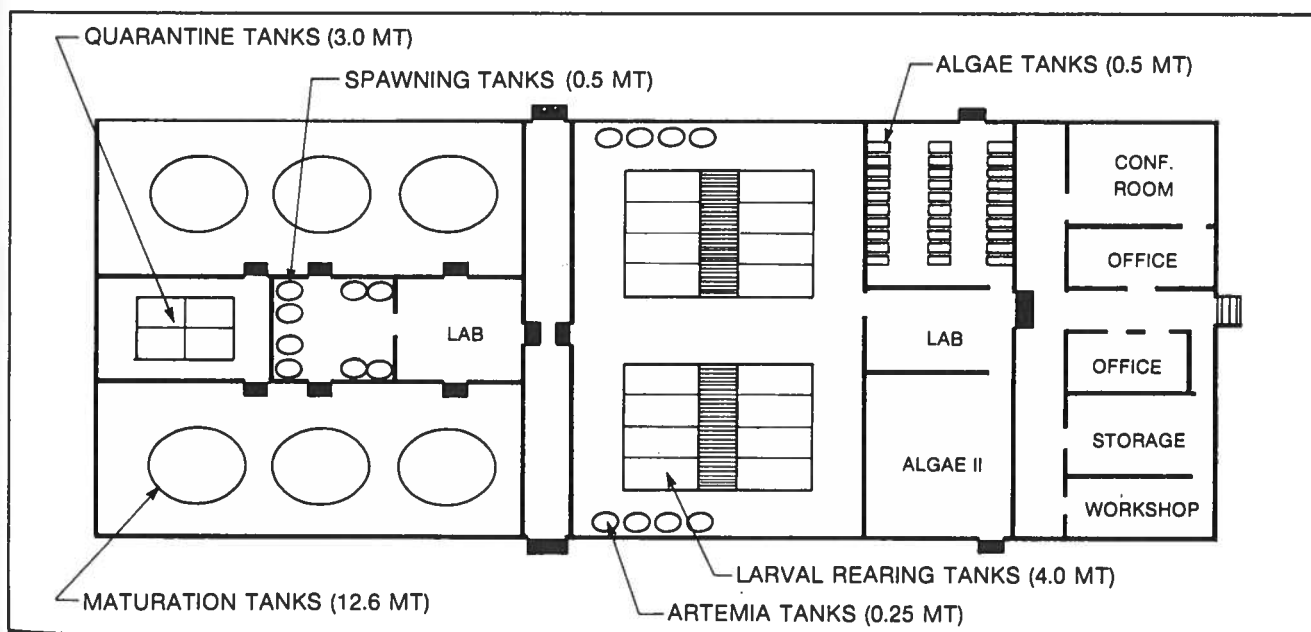

Figure 20E
CENTRAL AMERICAN HATCHERY TANKS/LOCATION

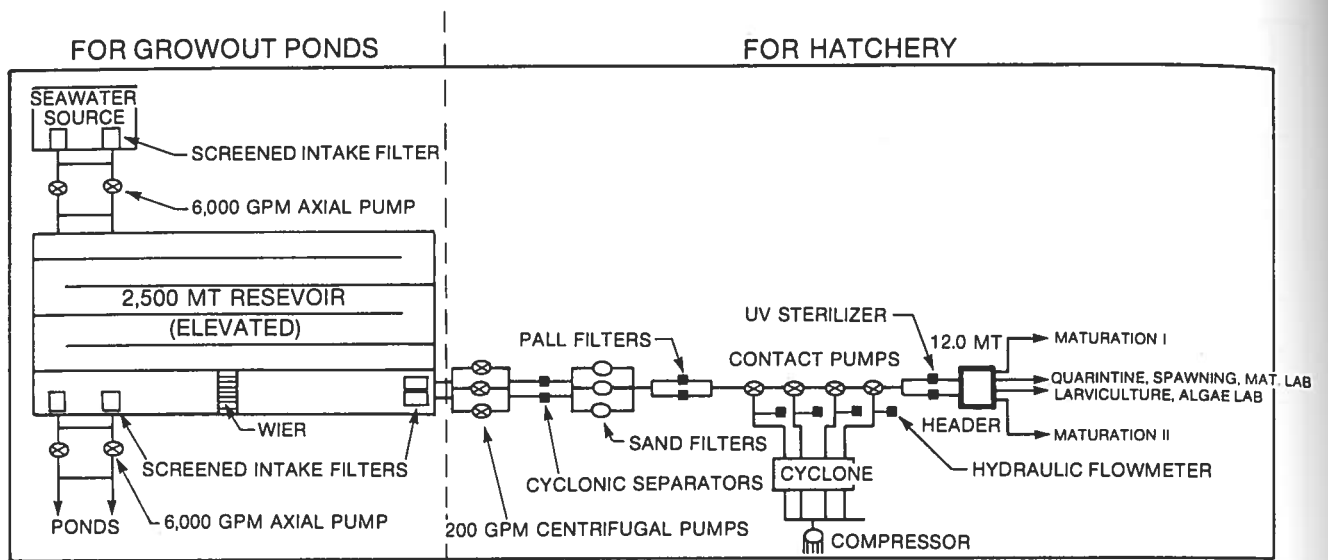

Figure 20F
 CONCEPTUAL DRAWING OF CENTRAL AMERICAN
 HATCHERY SEAWATER TREATMENT

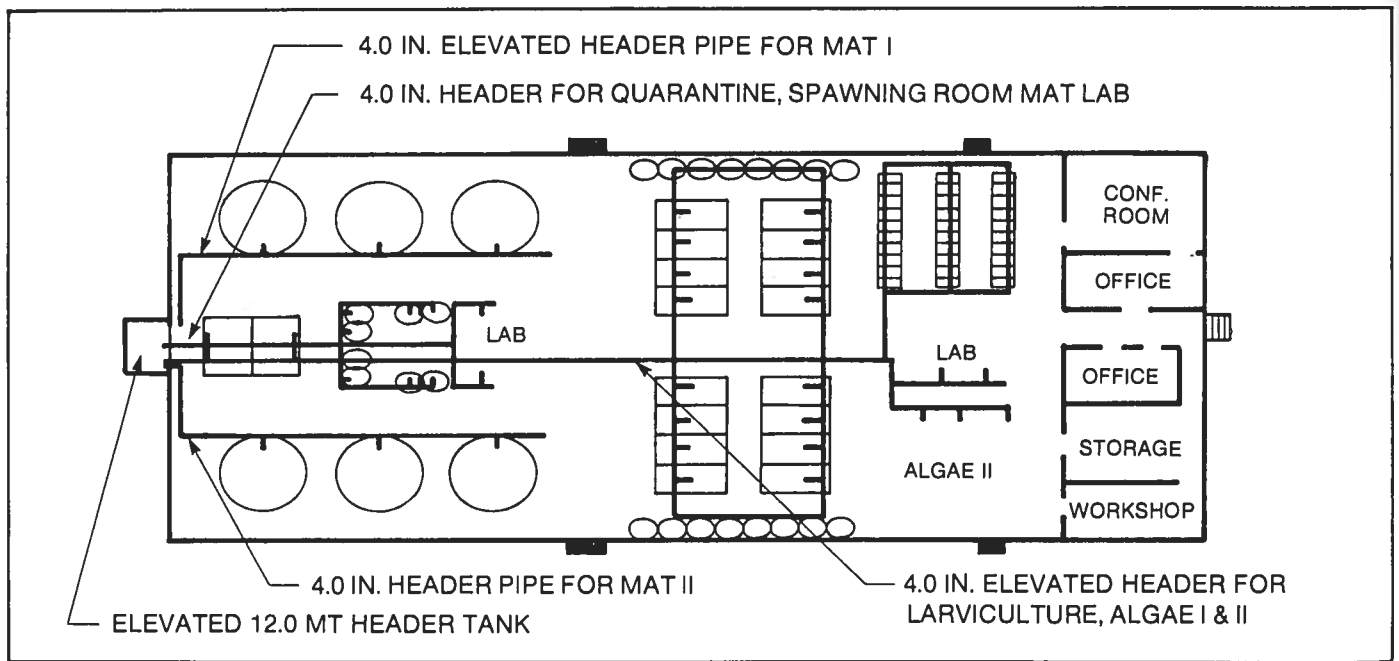

Figure 20G
 CENTRAL AMERICAN HATCHERY SEAWATER
 ELEVATED HEADER DISTRIBUTION SYSTEM

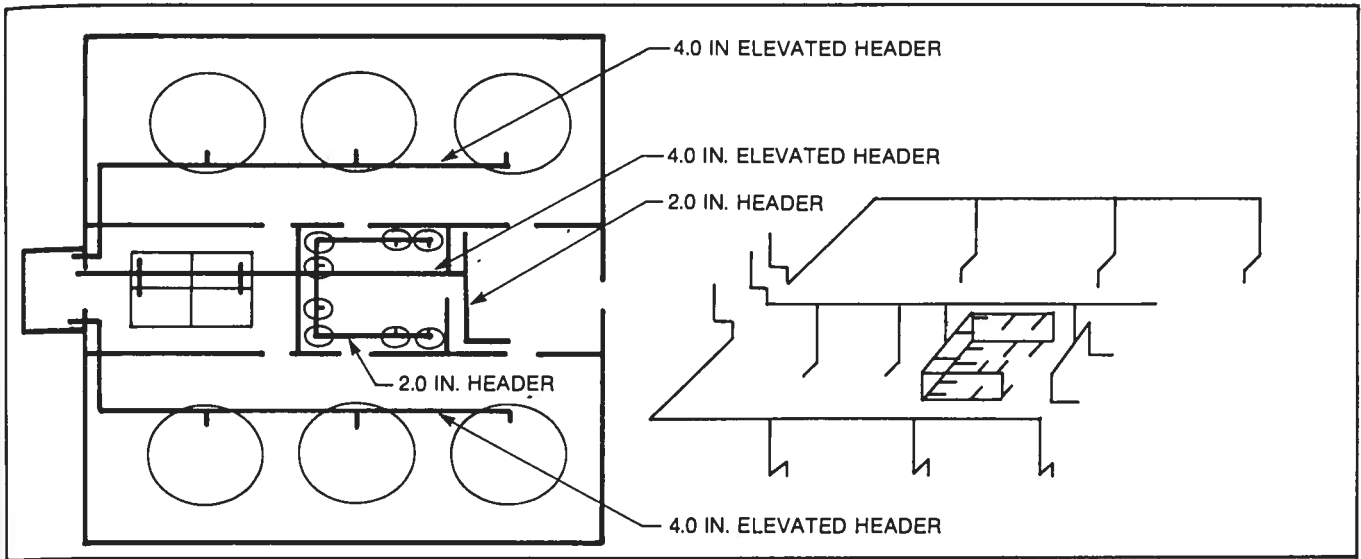

Figure 20H
CENTRAL AMERICAN HATCHERY
MATURATION FACILITY SEAWATER DISTRIBUTION

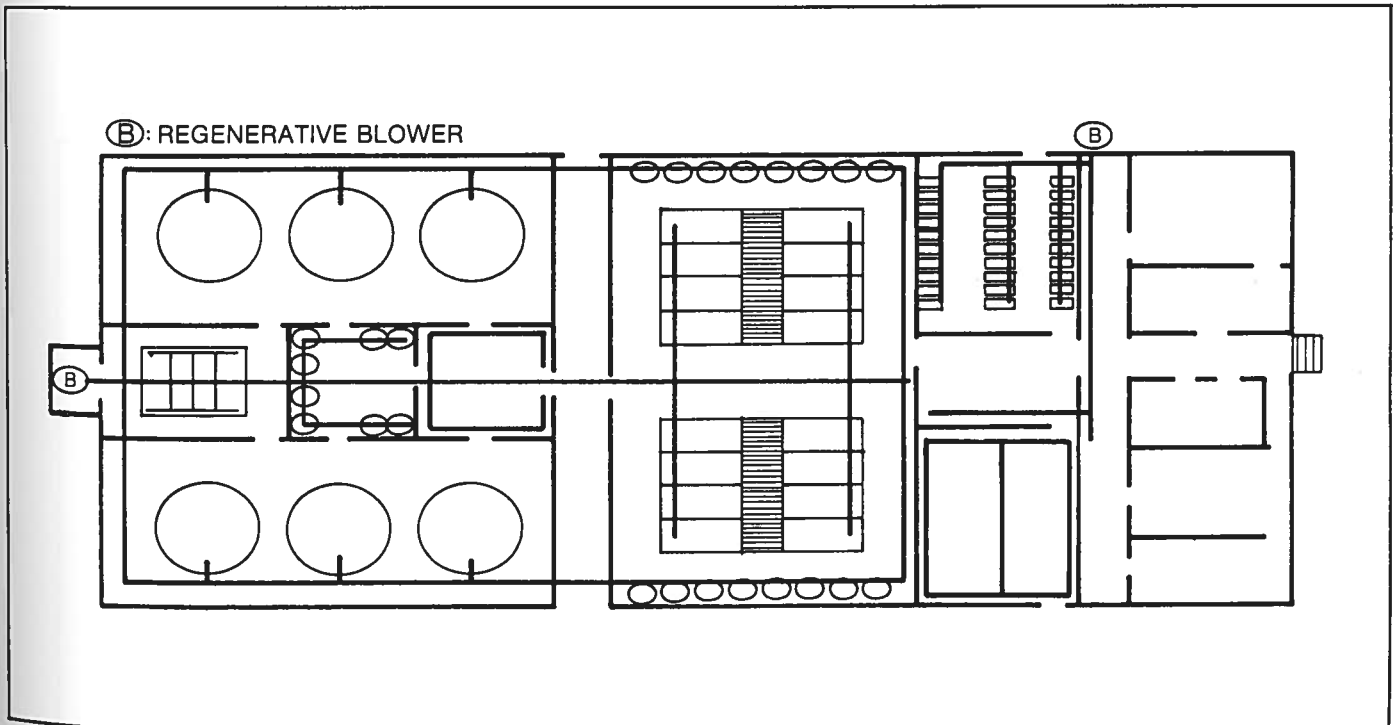

Figure 20I
CENTRAL AMERICAN HATCHERY BLOWER AERATION SYSTEM

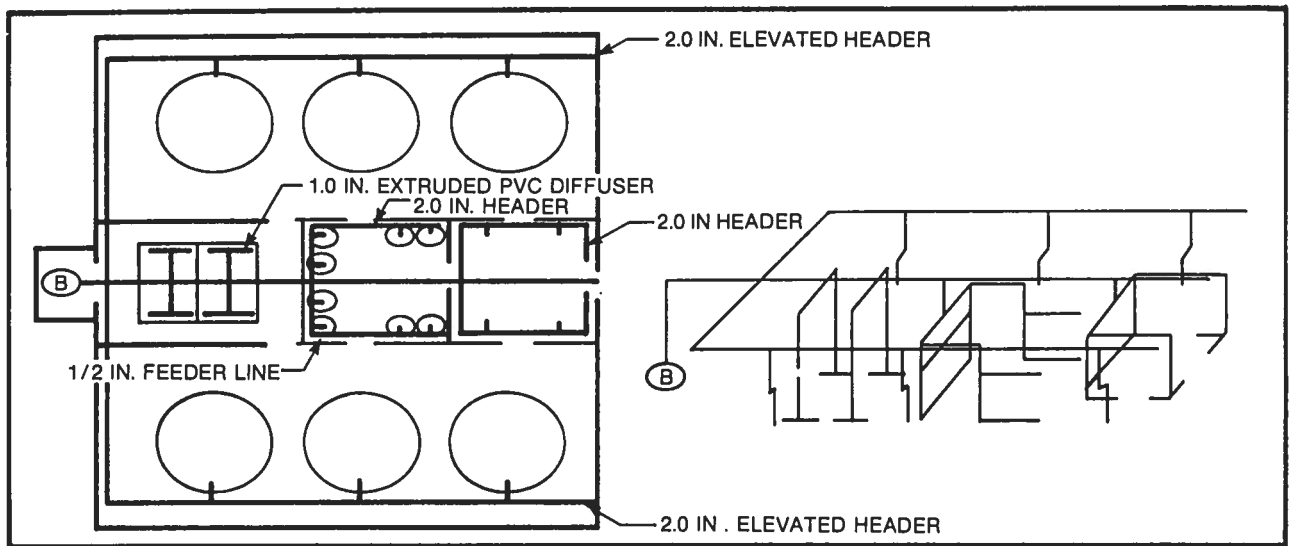

Figure 20J
CENTRAL AMERICAN MATURATION FACILITY
AERATION DISTRIBUTION SYSTEM

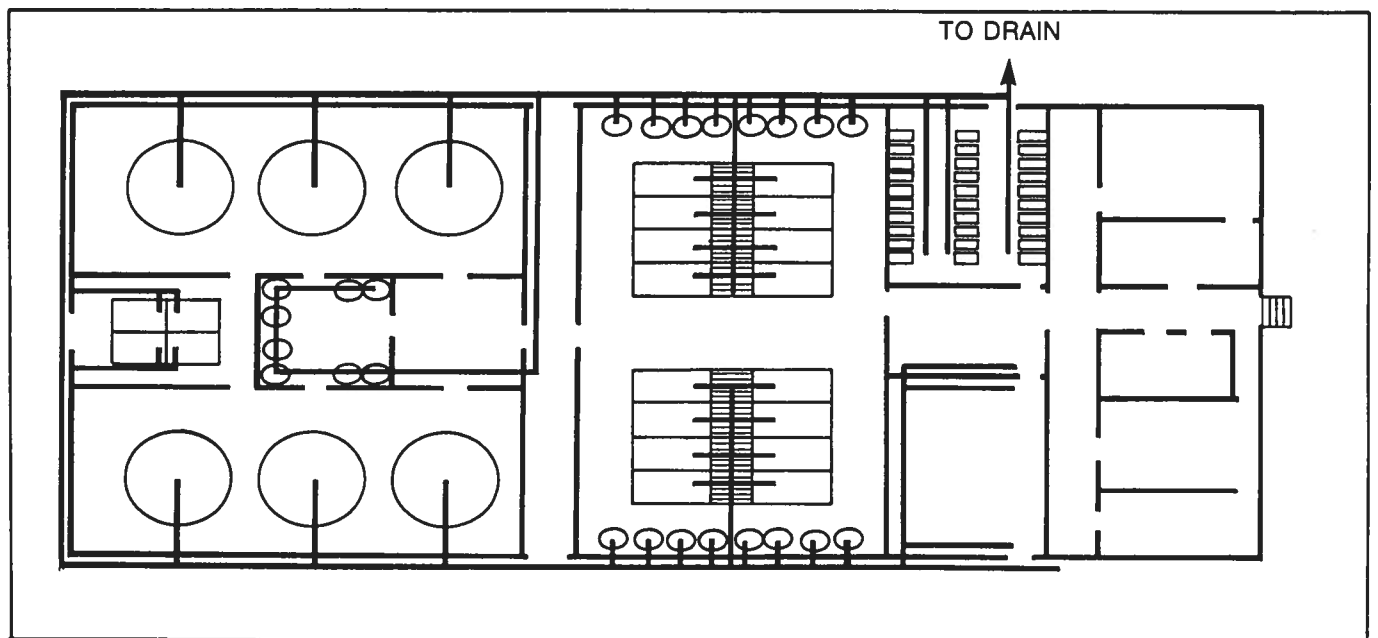

Figure 20K
CENTRAL AMERICAN HATCHERY DRAINAGE SYSTEM

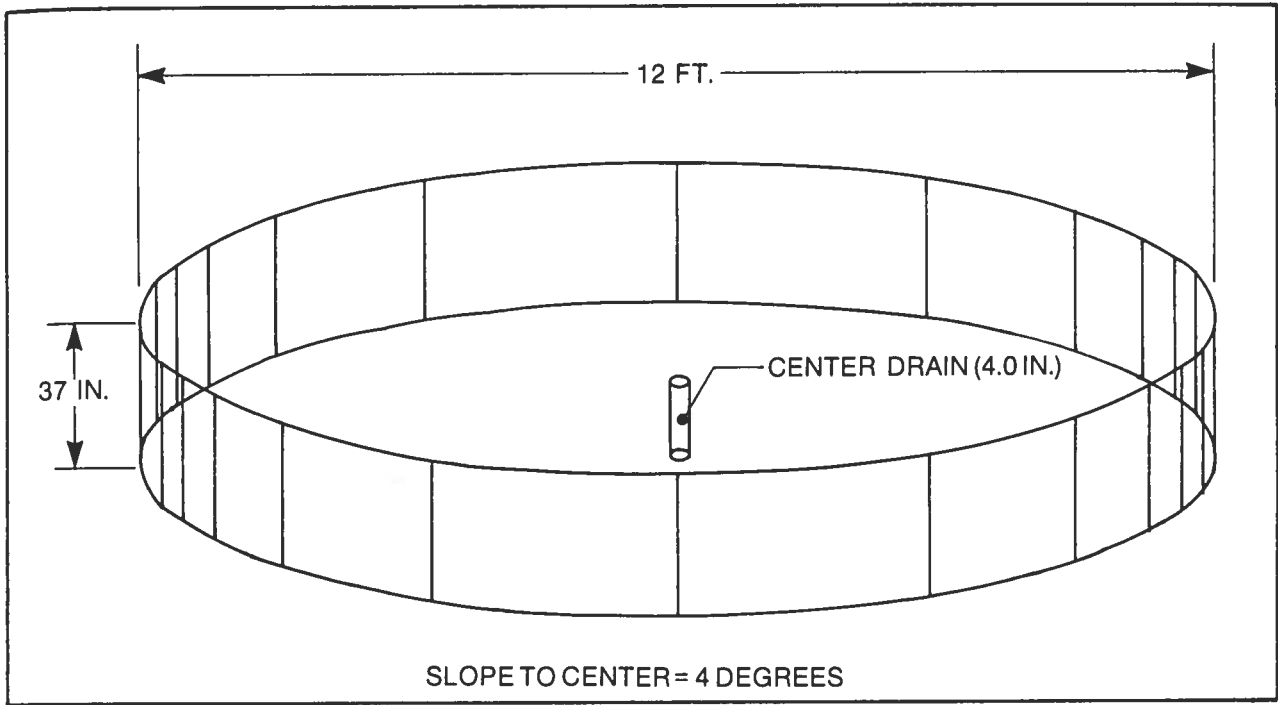

Figure 20L
CENTRAL AMERICAN FACILITY
MATURATION TANK DESIGN

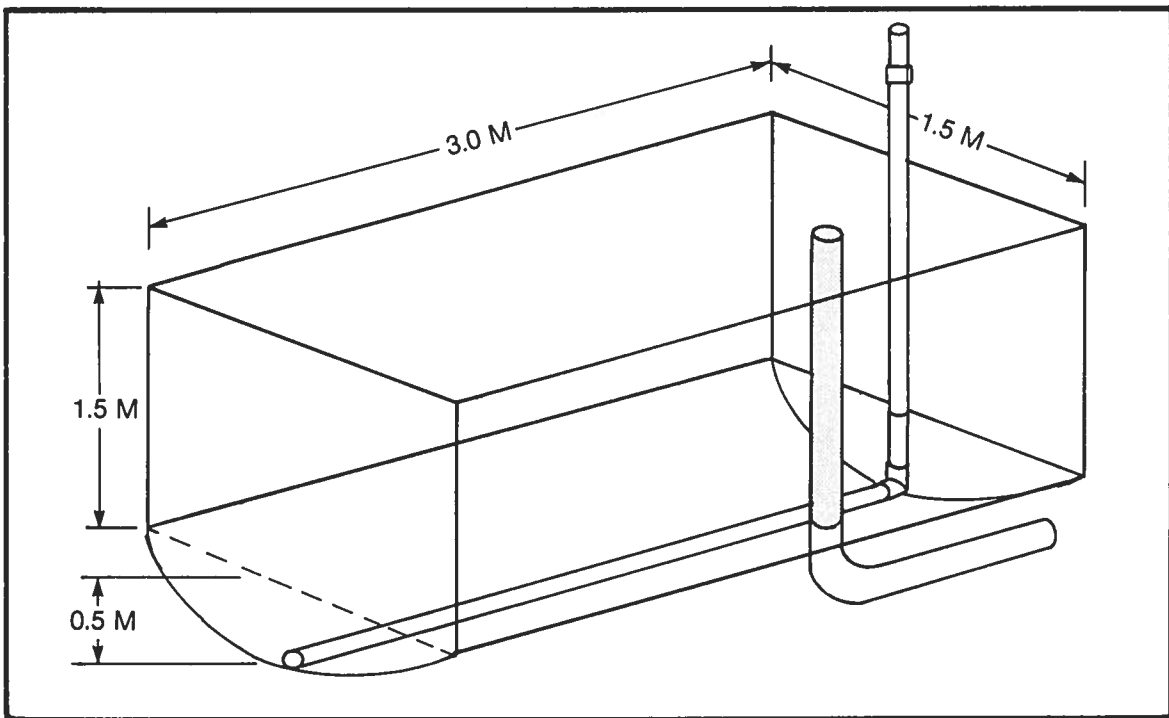

Figure 20M
CENTRAL AMERICAN
HATCHERY LARVAL REARING TANK

Appendices A through C give water analysis results for a potential hatchery site in South Texas in July 1990. Appendix D, excerpted from the Safe Drinking Water Act of 1986, gives drinking water maximum-contaminant levels for metals and should be used for comparative purposes only. Appendix E gives seawater parameters for comparative purposes. Appendix F gives primary components of seawater (Riley and Chester, 1971), Appendix G gives values for concentrations of trace elements in seawater (Quimby-Hunt and Turekian, 1983), Appendix H presents elements in seawater (Spotte, 1970), and Appendix I gives examples of pesticide levels toxic to penaeid shrimp.

Appendix A. Water Analysis Results for an Existing Hatchery in South Texas (July 1990).	
Sample ID: Trip Blank	
Compound	Concentration Found (µg/L) PPB (parts per billion)
Benzene	0.01 U
Toluene	0.01 U
Ethyl Benzene	0.01 U
Xylenes	0.02 U
U-Undetected, indicating not found above detection limit given.	
Sample ID: Low Tide (Intake Site)	
Compound	Concentration Found (µg/L) PPB
Benzene	0.01 U
Toluene	0.01 U
Ethyl Benzene	0.01 U
Xylenes	0.02 U
U-Undetected, indicating not found above detection limit given.	
Sample ID: High Tide (Intake Site)	
Compound	Concentration Found (µg/L) PPB
Benzene	0.01 U
Toluene	0.01 U
Ethyl Benzene	0.01 U
Xylenes	0.02 U
U-Undetected, indicating not found above detection limit given.	
Appendix D. Drinking Water Maximum Contaminant Levels for Metals (to be used for comparative purposes only)	
Nonchlorinated Water	Maximum Contaminant Level*
Primary Standards	(µg/L or PPM)
Arsenic (As)	0.05
Barium (Ba)	1.0
Cadmium (Cd)	0.010
Chromium (Cr)	0.05
Lead (Pb)	0.05
Mercury (Hg)	0.002
Nitrate (N)	10.0
Nitrate (NO ₃)	45.0
Selenium (se)	0.01
Silver (Ag)	0.05
Copper (Cu)	1.0
Iron (Fe)	0.3
Manganese (Mn)	0.05
Zinc (Zn)	5.0
*Excerpt from Safe Drinking Water Act of 1986	
**Lead levels adopted at 0.005 ppm (1990)	
Note: Detection limits for Arsenic in two samples are different due to sample matrix effect.	

Appendix B. Metal Results	
Sample ID: Trip Blank	
Parameter	Concentration (Mg/L) PPM (parts per million)
Silver	0.035 U
Barium	0.20 U
Cadmium	0.005 U
Chromium	0.01 U
Arsenic	0.003 U
Selenium	0.004 U
Lead	0.001 U
Mercury	0.0002 U
Copper	0.018 U
Tin	0.45 U
Zinc	0.015 U
Boron	0.3 U
U-Undetected, indicating not found above detection limit given.	
Sample ID: Low Tide (Potential Intake Site)	
Parameter	Concentration (Mg/L) PPM (parts per million)
Silver	0.05 U
Barium	1.0 U
Cadmium	0.01 U
Chromium	0.05 U
Arsenic	0.3 U
Selenium	0.16 U
Lead	0.566
Mercury	0.0002 U
Copper	0.009 U
Tin	2.25 U
Zinc	0.075 U
Boron	3.75
U-Undetected, indicating not found above detection limit given.	
Sample ID: High Tide (Potential Intake Site)	
Parameter	Concentration (Mg/L) PPM (parts per million)
Silver	0.270 — Standard 0.0003 Mg/L
Barium	1.0 U
Cadmium	0.01 U
Chromium	0.050 U
Arsenic	0.12 U
Selenium	0.16 U
Lead	0.452 — Standard 0.004 Mg/L
Mercury	0.0002 U
Copper	0.09 U
Tin	2.25 U
Zinc	0.075 U
Boron	3.70
U-Undetected, indicating not found above detection limit given.	

Appendix C. Pesticide Results.

Date Received: July 10, 1990

Sample ID: Trip Blank

40 CFR **	Compound Name (Common)	Result* µg/L (ppb)	40 CFR 180	Compound Name (Common)	Result* µg/L (ppb)	40 CFR 180	Compound Name (common)	Result* µg/L (ppb)
Organochlorines								
.249	Alachlor (Lasso)	0.5	.147	2,4'-DDT	0.125	.368	Metolachlor	0.05
.135	Aldrin	0.05	.147	4,4'-DDT	0.125	.332	Metribuzin	0.125
.220	Atrazine	1.25	.231	Dichlobenil (Casoron)	0.125	.223	Nitrofen (TOK)	0.25
.410	Bayleton	0.75	.118	Dichlone	1.25	.346	Ozadiazon (Ronstar)	0.25
.208	Benefin (Balan)	0.125	.200	Dichloran (Botran)	0.125	.381	Oxyflourfen (Goal)	0.25
.140	BHC (Benzahex)	0.05	.385	Diclofop-Methyl	0.25	.291	PCNB	0.1
.351	Bifenox (Modown)	0.25	.163	Dicofol (Kelthane)	1.25	.378	Permethrin	0.125
.324	Bromoxynil	0.5	.137	Dieldrin	0.05	.139	Perthane (Ethylan)	12.5
.267	Captafol	0.25	.158	Dyrene	1.25	.348	Profluralin (Tolban)	0.125
.103	Captan	0.5	.182	Endosulfan I, II, III	0.25	.317	Pronamide (Kerb)	0.1
.122	Chlordane	0.625	.131	Endrin	0.125	.211	Propachlor	7.08
.109	Chlorobenzilate (Acaraben)	5.0	.370	Etridiazole	0.25	.243	Propazine	0.625
.257	Chloroneb	0.25	.363	Fluchloralin (Basalin)	0.125	.416	Sonalan (Ethalfuralin)	0.125
.275	Chlorthalonil (Bravo)	0.25	.191	Folpet	2.5	.333	Terbutylazine	1.25
.418	Cypermethrin	0.125	.104	Heptachlor	0.025	.174	Tetradifon (Tedian)	0.5
.185	Dacthal	0.125	.104	Heptachlor Epoxide	0.05	.138	Toxaphene (Attac)	5
.187	2,4'-DDD	0.125	.399	Iprodione (Rovral)	5	.207	Trifluralin (Treflan)	0.125
.187	4,4'-DDD	0.125	.133	Lindane (Gamma-BHC)	0.05	.362	Vegadex	0.25
.147	2,4'-DDE	0.075	.184	Linuron	0.5	.380	Vinclozolin (Ronilan)	0.25
.147	4,4'-DDE	0.075	.120	Methoxychlor	1.25			
Organophosphates								
.108	Acephate	1.25	.171	Dioxathion (Delnav)	0.5	.157	Mevinphos (Phosdrin)	0.25
.154	Azinphos-Methyl (Glution)	5	.183	Disulfoton (Disyston)	0.25	.315	Monitor	0.5
.156	Bolstar	0.75	.119	EPN	0.75	.215	Naled (Dibrom)	0.5
.322	Carbophenothion (Trithion)	0.5	.173	Ethion	0.25	.349	Nemacur (Phenamiphos)	0.625
.342	Chlorfenvinphos (Supona)	0.75	.262	Ethoprop (Mocap)	0.125	.121	Parathion	0.25
.280	Chlorpyrifos (Dursban)	0.25	.214	Fenitrothion (Summithion)	0.25	.121	Parathion, Methyl	0.25
.189	Ciodrin	2.5	.214	Fenthion (Baytex)	0.5	.206	Phorate (Thimet)	0.25
.272	DEF (Butifos)	2.5	.234	Fensulfothion (Dasanit)	0.625	.263	Phosalone (Zolone)	5.0
.105	Demeton (Systox)	0.25	.221	Fonofos (Dyfonate)	0.25	.239	Phosphamidon (Dimecron)	1.25
.326	Dialifor (Torak)	0.25	.261	Hostathion (Triazophos)	0.75	.404	Profenofos (Curacron)	2.5
.153	Diazinon	0.25	.387	Imidan	2.5	.177	Propetamphos (Safrotin)	0.25
.235	Dichlorvos (DDVP)	0.25	.111	Isofenphos (Oftanol)	2.5	.252	Ronnel	0.25
.299	Dicrotophos (Bidrin)	0.25	.298	Malathion	0.25	.264	Tetrachlorvinphos	5.0
.204	Dimethoate (Cygon)	0.25		Methidathion (Supracide)	0.5		Thionazin (Zinophos)	0.25

*Results given represent method detection limits. No compounds were found above their respective detection limit.

**40 CFR 180 is a pesticide I.D. code (vol. 40, Code of Federal Regulations, Part 180 and then the specific pesticide # appears)

PCNB - Pentachloronitrobenzene

Appendix C continued Sample ID: Low Tide (Intake Site)

Date Received: July 10, 1990

40 CFR**	Compound Name (Common)	Result* µg/L (ppb)	40 CFR 180	Compound Name (Common)	Result* µg/L (ppb)	40 CFR 180	Compound Name (common)	Result* µg/L (ppb)
Organochlorines								
.249	Alachlor (Lasso)	0.5	.147	2,4'-DDT	0.125	.368	Metolachlor	0.05
.135	Aldrin	0.05	.147	4,4'-DDT	0.125	.332	Metribuzin	0.125
.220	Atrazine	1.25	.231	Dichlobenil (Casoron)	0.125	.223	Nitrofen (TOK)	0.25
.410	Bayleton	0.75	.118	Dichlone	1.25	.346	Ozadiazon (Ronstar)	0.25
.208	Benefin (Balan)	0.125	.200	Dichloran (Botran)	0.125	.381	Oxyflourfen (Goal)	0.25
.140	BHC (Benzahex)	0.05	.385	Diclofop-Methyl	0.25	.291	PCNB	0.1
.351	Bifenox (Modown)	0.25	.163	Dicofol (Kelthane)	1.25	.378	Permethrin	0.125
.324	Bromoxynil	0.5	.137	Dieldrin	0.05	.139	Perthane (Ethylan)	12.5
.267	Captafol	0.25	.158	Dyrene	1.25	.348	Profluralin (Tolban)	0.125
.103	Captan	0.5	.182	Endosulfan I, II, III	0.25	.317	Pronamide (Kerb)	0.1
.122	Chlordane	0.625	.131	Endrin	0.125	.211	Propachlor	7.08
.109	Chlorobenzilate (Acaraben)	5.0	.370	Etridiazole	0.25	.243	Propazine	0.625
.257	Chloroneb	0.25	.363	Fluchloralin (Basalin)	0.125	.416	Sonalan (Ethalfuralin)	0.125
.275	Chlorthalonil (Bravo)	0.25	.191	Folpet	2.5	.333	Terbutylazine	1.25
.418	Cypermethrin	0.125	.104	Heptachlor	0.025	.174	Tetradifon (Tedion)	0.5
.185	Dacthal	0.125	.104	Heptachlor Epoxide	0.05	.138	Toxaphene (Attac)	5
.187	2,4'-DDD	0.125	.399	Iprodione (Rovral)	5	.207	Trifluralin (Treflan)	0.125
.187	4,4'-DDD	0.125	.133	Lindane (Gamma-BHC)	0.05	.362	Vegadex	0.25
.147	2,4'-DDE	0.075	.184	Linuron	0.5	.380	Vinclozolin (Ronilan)	0.25
.147	4,4'-DDE	0.075	.120	Methoxychlor				
Organophosphates								
.108	Acephate	1.25	.171	Dioxathion (Delnav)	0.5	.157	Mevinphos (Phosdrin)	0.25
.154	Azinphos-Methyl (Glution)	5	.183	Disulfoton (Disyston)	0.25	.315	Monitor	0.5
	Bolstar	0.75	.119	EPN	0.75	.215	Naled (Dibrom)	0.5
.156	Carbophenothion (Trithion)	0.5	.173	Ethion	0.25	.349	Nemacur (Phenamiphos)	0.625
.322	Chlorfenvinphos (Supona)	0.75	.262	Ethoprop (Mocap)	0.125	.121	Parathion	0.25
.342	Chlorpyrifos (Dursban)	0.25		Fenitrothion (Sumithion)	0.25	.121	Parathion, Methyl	0.25
.280	Ciodrin	2.5	.214	Fenthion (Baytex)	0.5	.206	Phorate (Thimet)	0.25
.189	Coumaphos (Co-Ral)	2.5	.234	Fensulfthion (Dasanit)	0.625	.263	Phosalone (Zolone)	5.0
.272	DEF (Butifos)	0.25	.221	Fonofos (Dyfonate)	0.25	.239	Phosphamidon (Dimecron)	1.25
.105	Demeton (Systox)	0.2		Hostathion (Triazophos)	0.75	.404	Profenofos (Curacron)	2.5
.326	Dialifor (Torak)	2.5	.261	Imidan	2.5		Propetamphos (Safrotin)	0.25
.153	Diazinon	0.25	.387	Isofenphos (Ofatanol)	2.5	.177	Ronnel	0.25
.235	Dichlorvos (DDVP)	0.25	.111	Malathion	0.25	.252	Tetrachlorvinphos	5.0
.299	Dicrotophos (Bidrin)	0.25	.298	Methidathion (Supracide)	0.5	.264	Thionazin (Zinophos)	0.25
.204	Dimethoate (Cygon)	0.25						

*Results given represent method detection limits. No compounds were found above their respective detection limit.

**40 CFR 180 is a pesticide I.D. code (vol. 40, Code of Federal Regulations, Part 180 and then the specific pesticide # appears)

PCNB - Pentachloronitrobenzene

Appendix C continued Sample ID: High Tide (Intake Site)

Date Received: July 10, 1990

40 CFR**	Compound Name (Common)	Result* µg/L (ppb)	40 CFR 180	Compound Name (Common)	Result* µg/L (ppb)	40 CFR 180	Compound Name (Common)	Result* µg/L (ppb)
Organochlorines								
.249	Alachlor (Lasso)	0.5	.147	2,4'-DDT	0.125	.368	Metolachlor	0.05
.135	Aldrin	0.05	.147	4,4'-DDT	0.125	.332	Metribuzin	0.125
.220	Atrazine	1.25	.231	Dichlobenil (Casoron)	0.125	.223	Nitrofen (TOK)	0.25
.410	Bayleton	0.75	.118	Dichlone	1.25	.346	Ozadiazon (Ronstar)	0.25
.208	Benefin (Balan)	0.125	.200	Dichloran (Botran)	0.125	.381	Oxyflourfen (Goal)	0.25
.140	BHC (Benzahex)	0.05	.385	Diclofop-Methyl	0.25	.291	PCNB	0.1
.351	Bifenox (Modown)	0.25	.163	Dicofol (Kelthane)	1.25	.378	Permethrin	0.125
.324	Bromoxynil	0.5	.137	Dieldrin	0.05	.139	Perthane (Ethylan)	12.5
.267	Captafol	0.25	.158	Dyrene	1.25	.348	Profluralin (Tolban)	0.125
.103	Captan	0.5	.182	Endosulfan I, II, III	0.25	.317	Pronamide (Kerb)	0.1
.122	Chlordane	0.625	.131	Endrin	0.125	.211	Propachlor	7.08
.109	Chlorobenzilate (Acaraben)	5.0	.370	Etridiazole	0.25	.243	Propazine	0.625
.257	Chloroneb	0.25	.363	Fluchloralin (Basalin)	0.125	.416	Sonalan (Ethalfluralin)	0.125
.275	Chlorthalonil (Bravo)	0.25	.191	Folpet	2.5	.333	Terbuthylazine	1.25
.418	Cypermethrin	0.125	.104	Heptachlor	0.025	.174	Tetraedion (Tedian)	0.5
.185	Dacthal	0.125	.104	Heptachlor Epoxide	0.05	.138	Toxaphene (Attac)	5
.187	2,4'-DDD	0.125	.399	Iprodione (Rovral)	5	.207	Trifluralin (Treflan)	0.125
.187	4,4'-DDD	0.125	.133	Lindane (Gamma-BHC)	0.05	.362	Vegadex	0.25
.147	2,4'-DDE	0.075	.184	Linuron	0.5	.380	Vinclozolin (Ronilan)	0.25
.147	4,4'-DDE	0.075	.120	Methoxychlor				
Organophosphates								
.108	Acaphate	1.25	.171	Dioxathion (Delnav)	0.5	.157	Mevinphos (Phosdrin)	0.25
.154	Azinphos-Methyl (Glution)	5	.183	Disulfoton (Disyston)	0.25	.315	Monitor	0.5
	Bolstar	0.75	.119	EPN	0.75	.215	Naled (Dibrom)	0.5
.156	Carbophenothion (Trithion)	0.5	.173	Ethion	0.25	.349	Nemacur (Phenamiphos)	0.625
.322	Chlorfenvinphos (Supona)	0.75	.262	Ethoprop (Mocap)	0.125	.121	Parathion	0.25
.342	Chlorpyrifos (Dursban)	0.25		Fenitrothion (Sumithion)	0.25	.121	Parathion, Methyl	0.25
.280	Ciodrin	2.5	.214	Fenthion (Baytex)	0.5	.206	Phorate (Thimet)	0.25
.189	Coumaphos (Co-Ral)	2.5	.234	Fensulfthion (Dasanit)	0.625	.263	Phosalone (Zolone)	5.0
.272	DEF (Butifos)	0.25	.221	Fonofos (Dyfonate)	0.25	.239	Phosphamidon (Dimecron)	1.25
.105	Demeton (Systox)	0.25		Hostathion (Triazophos)	0.75	.404	Profenofos (Curacron)	2.5
.326	Dialifor (Torak)	0.25	.261	Imidan	2.5		Propetamphos (Safrotin)	0.25
.153	Diazinon	0.25	.387	Isofenphos (Oftanol)	2.5	.177	Ronnel	0.25
.235	Dichlorvos (DDVP)	0.25	.111	Malathion	0.25	.252	Tetrachlorvinphos	5.0
.299	Dicrotophos (Bidrin)	0.25	.298	Methidathion (Supracide)	0.5	.264	Thionazin (Zinophos)	0.25
.204	Dimethoate (Cygon)	0.25						

*Results given represent method detection limits. No compounds were found above their respective detection limit.

**40 CFR 180 is a pesticide I.D. code (vol. 40, Code of Federal Regulations, Part 180 and then the specific pesticide # appears)

PCNB - Pentachloronitrobenzene

Appendix E. Seawater Analyses from Other Areas of the World and Normal Seawater (all ions in ppm)									
	Hawaii ¹	Guam ¹	Sabah, ¹ Malaysia	Qingdao, ⁴ China	Normal ² Seawater	Normal ³ Surface Seawater	Normal ⁵ Seawater	Fumba ⁶ Zanzibar Africa	Bumbwini ⁷ Zanzibar Africa
Silica (SiO ₂)	—	14	1.5	trace	—	—	—	—	—
Iron (Fe)	—	0.3	0.23	—	0.02	—	—	0.25-0.26	0.30
Manganese (Mn)	—	0.06	0.04	—	0.01	—	—	—	—
Boron	—	—	—	—	—	—	4.5	—	—
Calcium (Ca)	390	450	—	—	400	—	412	—	—
Magnesium (Mg)	1,250	1,175	—	—	1,272	—	837-839	900-940	—
Sodium (Na)	10,500	9,400	—	—	10,556	—	10,773	—	—
Potassium (K)	418	350	—	—	380	—	399	—	—
Cadmium (Cd)	—	—	0.05	0.01-0.13	—	0.01	—	0.01	0.01
Chromium (Cr)	—	—	0.03	—	—	—	—	—	—
Bicarbonate (HCO ₃)	162	160	—	—	—	—	142	—	—
Bromide (BR ⁻)	—	—	—	—	—	—	67.4	—	—
Carbonate (CO ₃)	—	—	—	—	—	—	—	—	—
Sulfate (SO ₄)	2,780	2,510	1,600	—	2,648	—	2,712	—	2,769
Chloride (CL)	19,000	17,460	16,300	—	18,978	—	19,344	—	—
Fluoride (F)	1	0.7	—	—	—	—	1.3	—	—
Nitrate (NO ₃)	—	3.5	0.23	—	—	—	—	—	—
Nitrite	—	—	0.01	—	—	—	—	—	—
Ammoniacal Nitrogen	—	—	0.02	—	—	—	—	—	—
Cobalt (Co)	—	—	0.24	—	—	—	—	—	—
Copper (Cu)	—	—	0.03	0.3-2.1	—	0.04-0.1	—	0.08	0.09
Zinc (Zn)	—	—	0.06	0.9-3.2	—	0.1	—	—	—
Lead (Pb)	—	—	0.14	0.1-2.0	—	0.005-0.1	—	0.08-0.11	0.08
Phosphate (PO ₄)	—	—	—	—	—	—	—	—	—
Strontium	—	—	—	—	—	—	7.9	—	—
Total Solid Content	—	—	34,500	—	—	—	—	—	—
Suspended Solids	—	—	1,150	—	—	—	—	—	—
Dissolved Solids	—	—	33,400	—	—	—	—	—	—
Residue on evaporation at 180 degrees C. Calculated	—	—	—	—	—	—	—	—	—
Hardness on CaCO ₃	34,400	—	34,200	—	—	—	—	—	—
Alkalinity, CaCO ₃	6,120	5,720	5,300	—	—	—	—	—	—
Calcium Hardness, CaCO ₃	133	117	109	—	—	—	—	—	—
Noncarbonate Hardness as CaCO ₃	—	—	20	—	—	—	—	—	—
Specific Conductance (micromhos at 25°C)	—	—	—	—	—	—	—	—	—
pH	51,000	73,000	—	—	—	—	—	69,300	62,700
Salinity	6.6	7.7	7.4	—	7.4*	—	—	8.0	7.3
Dissolved Oxygen	—	—	30	—	35	—	—	34	33
Turbidity, N.T.U.	—	—	4.3	—	—	—	—	5.0	4.9
	—	—	8.5	—	—	—	—	50 cm	40 cm

Sources: ¹ Fujimura, 1989; ² Sverdrup *et al.*, (1970); ³ Förstner and Wittman, (1979); and ⁴ Yuan *et al.*, (1992); ⁵ Riley and Chester (1971); ⁶ Treece and Yates (1992) unpublished feasibility study, open ocean site; ⁷ Treece and Yates (1992) unpublished feasibility study, mangrove swamp-low tide.

* Note: Most sources state that normal pH of seawater is 8.0.

Appendix F. Primary Components of Seawater*

Ion	g/kg of water, salinity 35 ppt	ppm
Chloride	19.334	19,344
Sodium	10.773	10,773
Sulphate	2.712	2,712
Magnesium	1.294	1,294
Calcium	0.412	412
Potassium	0.399	399
Bicarbonate	0.142	142
Bromide	0.0674	67.4
Strontium	0.0079	7.9
Boron	0.0045	4.5
Fluoride	0.0013	1.3

*From: Riley and Chester (1971).

Appendix G. Values for Concentrations of Selected Trace Elements in Seawater at Salinity of 35 ppt with Standardized Nutrient Levels. **

Element	Concentration (ng/kg)	Reference ¹
Chromium (Cr)	330	A
Manganese (Mn)	10	B
Iron (Fe)	40	C
Cobalt (Co)	2	D
Nickel (Ni)	480	E
Copper (Cu)	120	E
Zinc (Zn)	390	E
Selenium (Se)	170	F
Cadmium (Cd)	70	E
Mercury (Hg)	6	G
Lead (Pb)	1	H

**Quimby-Hunt and Turekian (1983)

¹References: A. Cranston (1979); B. Landing and Bruland (1980); C. Gordon *et al.*, (1982); D. Knauer *et al.*, (1982) E. Bruland (1980); F. Measures and Burton (1980); G. Mukherji and Kester (1979); H. Schaule and Patterson (1981).**Appendix H. Elements in Seawater.**

Element	Chemical Form	Amount, ppm	Element	Chemical Form	Amount, ppm
Ag	AgCl ²⁻	0.0003	Mg	Mg ²⁺	1,350
Al		0.01	Mn	Mn ²⁺	0.002
Ar		0.6	Mo	MoO ₄ ²⁻	0.01
As	AsO ₄ HS ⁻	0.003	n	Organic N,NO ₃ ⁻ ,NH ₄ ⁺	0.5
Au	AuCl ₄ ⁻	0.000011	Na ⁺		10,500
B(OH) ₃		4.6	Nb		0.00001
Ba	Ba ²⁺	0.03	Ne		0.00014
Be		0.0000006	Ni	Ni ²⁺	0.0054
Bi		0.000017	O	H ₂ O,O ₂ ,SO ₄ ²⁻	857,000
Br	Br ⁻	65	P	PO ₄ H ₂ ⁻	0.07
C	CO ₃ H ⁻ ,organic C	28	Pa		2x10 ⁻⁹
Ca	Ca ²⁺	400	Pb	Pb ²⁺	0.00003
Cd	Cd ²⁺	0.00011	Ra		6x10 ⁻¹¹
Ce		0.0004	Rb ⁺		0.12
Cl	Cl ⁻	19,000	Rn		6x10 ⁻¹⁶
Co	Co ²⁺	0.00027	S	SO ₄ ²⁻	885
Cr		0.00005	Sb		0.00033
Cs ⁺		0.0005	Sc		<0.000004
Cu	Cu ²⁺	0.003	Se		0.00009
F		1.3	Si(OH) ₄		3
Fe(OH) ₃		0.01	Sn		0.003
Ga		0.00003	Sr	Sr ⁹⁺	8.1
Ge(OH) ₄		0.00007	Ta		<0.0000025
H	H ² O	108,000	Th		0.00005
He		0.0000069	Ti		0.001
Hf		<0.000008	Tl ⁺		<0.00001
Hg	HgCl ₄ ²⁻	0.000008	U	UO ₂ (CO ₃) ₃ ⁴⁻	0.003
I	I ⁻ ,IO ₃	0.06	V	VO ₅ H ₃ ²⁻	0.002
In		<<0.02	W	WO ₄ ²⁻	0.0001
K ⁺		380	Xe		0.000052
Kr		0.0025	Y		0.0003
La		0.000012	Zn	Zn ²⁺	0.01
Li ⁺		0.18	Zr		0.000022

Appendix I. Examples of pesticide levels toxic to penaeid shrimp or related species. These values are taken from short-term toxicity tests, and lower levels can be expected to influence reproduction.

Compound	Level	Period	Effect	Species	Reference
Aroclor 1016	0.9 ppb	96 hr.	8% mortality	<i>P. aztecus</i>	A
Aroclor 1016	10.0 ppb	96 hr.	43% mortality	<i>P. aztecus</i>	A
Aroclor 1254	0.9 ppb	14 days	Some mortality	<i>P. duorarum</i>	C,D,E
Aroclor 1254	3.0 ppb	30 days	50% mortality	<i>P. duorarum</i>	F
DDT	0.1 ppb	8 days	mortality	<i>P. setiferus</i>	F
DDT	<0.1 ppb	28 days	mortality	<i>P. duorarum</i>	F
Diazinon	4.8 ppb	96 hr.	50% mortality	<i>Mysidopsi bahia</i>	G
Diazinon	3.2 ppb	96 hr.	low growth	<i>Mysidopsi bahia</i>	G
Diazinon	28.0 ppb	96 hr.	50% mortality	<i>P. aztecus</i>	G
Dibrom	2.0 ppb	48 hr.	50% mortality	<i>P. aztecus</i> PLs	H
Dibrom	5.5 ppb	48 hr.	50% mortality	<i>P. aztecus</i> adult	H
Dieldrin	0.9 ppb	96 hr.	50% mortality	<i>P. aztecus</i>	I
Heptachlor	0.11 ppb	96 hr.	50% mortality	<i>P. duorarum</i>	J
Malathion	14.0 ppb	48 hr.	mortality	penaeids	K
Metamidophos	10.0 ng/l	24 hr.	50% mortality	<i>P. stylirostris</i> nauplii	L
Mirex	1.0 ppb	7 days	25% mortality	<i>P. duorarum</i>	M,N,O
Parathion	0.2 ppb	48 hr.	mortality	<i>P. duorarum</i>	K
Parathion	1.0 ppb	96 hr.	25% mortality	<i>Crangon septimspinosa</i>	P
Parathion	2.0 ppb	96 hr.	25% mortality	<i>Palaemonetes vulgaris</i>	P

References: A. Hansen *et al.*, 1974; B. Couch and Nimmo, 1974; C. Duke *et al.*, 1970; D. Nimmo *et al.*, 1971; E. Nimmo *et al.*, 1975; F. Nimmo *et al.*, 1970; G. Nimmo *et al.*, 1981; H. Butler and Springer, 1963; I. Parrish *et al.*, 1973; J. Schimmel *et al.*, 1976; K. Couch, 1978; L. Juarez and Sanchez, 1979; M. Lowe *et al.*, 1971; N. Tagatz *et al.*, 1974; O. Markin *et al.*, 1974; P. Eisler, 1979. (Table from Bray and Lawrence, 1991.)

Appendix J. Example of soil investigations at two potential hatchery sites in Indonesia. These soil analyses were conducted by a reputable laboratory and excerpts of the results can be seen in this appendix.

Soil Physical Sampling

Soil sampling for physical tests was taken on the excavation hole at the depth of 0.5 m and 1.0 m through a 150 mm thinwall and treated as undisturbed sample.

The thinwall was put in a plastic can and sealed by a plastic band so the moisture content was kept constant.

The crust soil at site 1 showed a layer of soft silty clay with a trace of shell. The ground water level ranged between 0.7 - 0.9 m below the surface.

At site 2 the crust soil was a very soft silty clay with a trace of shell and inundated with water.

The results of the soil laboratory tests could be summarized as follows:

Physical Characteristics	Site 1	Site 2
Natural M.C. (%)	40.00-54.00	54.30-65.9
Specific gravity	2.52-2.57	2.50-2.53
Bulk density (gr/cm ³)	1.57-1.75	1.46-1.59
Natural void ratio	1.06-1.47	1.46-1.84
Degree of saturation	92.50-97.70	89.50-94.20
Liquid limit (%)	98.70-101.70	102.5-105.0
Plastic limit (%)	37.80-41.50	40.0-41.5
Plasticity index (%)	59.0-61.7	62.5-64.1
Passing sieve #200 (%)	97.0-99.0	94.0-99.0
Cohesion (kg/cm ²)	0.27	0.06
Angle of shear resistance (°) ²	9.5	3.0

Chemical test on soil sample

The following methods were used to determine the results of chemical test on soil samples.

- pH (H₂O): glass electrode, using a 1: 2.5 suspension of soil in distilled water.
- Total sulphate: gravimetric
- Organic carbon: Walkey and black
- Available phosphorus: Bray I
- Exchangeable aluminium: colorimetric using Aluminon reagent
- Total iron: A.A.S.

Selected References

1. Bruland, K.W. 1980. Oceanographic distributions of cadmium, zinc, nickel and copper in the north Pacific. *Earth Planet. Sci. Lett.* 47: 176-198.
2. Cranston, R.E. 1979. Chromium species in natural waters. Ph.D. dissertation, University of Washington, Seattle, Wash., U.S.A.
3. Cruz, C.R. 1983. **Fishpond Engineering: a technical manual for small and medium scale coastal fish farms in S.E. Asia.** South China Seas Fisheries Dev. and Coordinating Program, manual No. 5., S.C.S., Manila, Philippines.
4. Forstner, U. and G.T.W. Wittmann. 1979. **Metal pollution in the aquatic environment.** Springer-Verlag, Berlin, Germany.
5. Fujimura, T. 1989. Mangement of a Shrimp Farm in Malaysia. *In Proceedings of the Southeast Asia Shrimp Farm Management Workshop.* Ed. Dean Akiyama, American Soybean Assn., pp. 22-41.
6. Grasshoff, K., M. Ehrhardt and K. Kremling. 1983. **Methods of seawater analysis.** Verlag Chemie, Weinheim, Federal Republic of Germany.
7. Knauer, G.A., J.H. Martin and R.M. Gordon. 1982. Iron in northeast Pacific waters. *Nature.* 297: 49-51.
8. Landing, W.M. and K.W. Bruland. 1980. Manganese in the North Pacific. *Earth Planet. Sci. Lett.* 49: 45-56.
9. Liao, I.C. 1984. A brief review of the larval rearing techniques of penaeid prawns. **Proceedings of the First International Conference on Culture of Penaeid Prawns/Shrimp.** Iloilo City, Philippines. p. 65-78.
10. Measures, C.I. and J.D. Burton. 1980. The vertical distribution and oxidation states of dissolved selenium in the northeast Atlantic Ocean and their relationship to biological processes. *Earth Planet. Sci. Lett.* 46: 385-396.
11. McLeese, D.W. 1974. Toxicity of copper at two temperatures and three salinities to the American lobster (*Homarus americanus*). *J. Fish. Res. Board Can.* 31: 1949.
12. Mukherji, P. and D.R. Kester. 1979. Mercury distribution in the Gulf Stream. *Science.* 204: 64-66.
13. Quimby-Hunt, M.S. and K.K. Turekian. 1983. Distribution of elements in sea water. *The Oceanogr. Rep. Eos, Trans. Am. Geophys. Union.* 64: 130-131.
14. Riley, J.P. and R. Chester. 1971. **Introduction to Marine Chemistry.** Academic Press, London, 465 pp.
15. Rosenberry, B. 1992. **World Shrimp Farming. Aquaculture Digest.** San Diego, Calif., U.S.A.
16. Spotte, S.H. 1970. **Fish and invertebrate culture. Water management in closed systems.** Wiley, Interscience, New York, London-Sydney-Toronto. p. 90-91.
17. Strickland, J.D.H. and T.R. Parsons. 1972. **A practical handbook of seawater analysis.** Bulletin of the Fisheries Research Board of Canada, No. 167. Alger Press Ltd., Ottawa, Canada.
18. U.S. Environmental Protection Agency. 1986. **Test Methods for Evaluating Solid Waste.** EPASW-846.
19. U.S. Environmental Protection Agency. **Methods for Chemical Analysis of Water and Wastes.** EPA 600/4-79-020.
20. Treece, G.D. and J.M. Fox. 1987. The establishment of a successful *Penaeus monodon* hatchery in Jepara, Indonesia. *World Aqua. Soc. 18th Annual Conf.* p. 35.
21. Treece, G.D. and M.E. Yates. 1990. **Laboratory Manual for the Culture of Penaeid Shrimp Larvae.** Texas A&M University, TAMU-SG-88-202(r). College Station, Tex., U.S.A.
22. Treece, G.D. and M.E. Yates. 1992. Unpublished feasibility study for Zanzibar, East Africa.
23. Yuan, Y.X., C.N. Gao and D.X. Zhang. 1992. Metamorphosis to postlarvae of *P. chinensis* Osbeck by removal of heavy metals from rearing systems with polymeric absorbent. *Journal World Aqua. Soc.* 23(3): 205-210.

Chapter 2

Maturation and Hatching

Although lack of a reliable supply of postlarvae is undoubtedly one of the biggest sources of uncertainty, inefficiency and economic loss facing shrimp farmers world wide (along with the threat of diseases), many farmers still rely on wild postlarvae as their "seed." Some rely on ready-to-spawn adult females from the oceans as a source of seed. However, an increasing number of farms are adopting technology to control the reproductive process and to produce generation after generation of shrimp without totally relying on the wild population. This technology offers independence from the unpredictable fluctuations in wild populations; accessibility to the superior non-indigenous species; improvement in performance through artificial selection; and some control over the diseases found in wild stocks.

The technology for control of shrimp reproduction is still young and under constant refinement by commercial and academic groups. The most important breakthroughs in this area occurred about 20 years ago. The market on technology was implemented on a commercial scale by a few advanced farms about ten years ago, but it has spread slowly because of the reluctance of leading farms to share "proprietary" information. Seventh and eighth generation broodstock have now been utilized by hatcheries with good results and the farms claim to have superior PLs in comparison to PLs from other broodstock sources. Pond growout comparisons were made in 1989 with different PL sources; therefore, there may be documented proof of these claims, but again, the results are "proprietary." The Oceanic Institute has recently reported disease-free broodstock lines as a result of work at its facilities in Hawaii (Oceanic Institute, 1990), but much more research is needed in this area. Specific Pathogen Free (SPF) or "high Health" animals have proven successful in helping domesticate the shrimp.

Species Matured in Captivity

A number of species have been tested, at least on a preliminary basis, and ovarian maturation and spawning have been accomplished experimentally. However, the quality, frequency and size of spawns from captive females vary greatly and culture standards for nutritional, physical and hormonal factors are only broadly defined. Of the species of marine shrimp of the family *Penaeidae*, genus *Penaeus* (Holthius, 1980), many have been matured and spawned in captivity and viable eggs produced, including: *P. aztecus*, *P. brasiliensis*, *P. californiensis*, *P. indicus*, *P. japonicus*, *P. kerathurus*, *P. merguensis*, *P. monodon*, *P. duorarum*, *P. penicillatus*, *P. plebejus*, *P. setiferus*, *P. stylirostris*, *P. vannamei*, *P. chinensis*, *P. merguensis*, *P. canaliculatus*, *P. esculentus*, *P. latisulcatus*, *P. marginatus*, *P. occidentalis*, *P. paulensis*, *P. schmitti*, *P. semisulcatus*, *P. teraoi* and *P. subtilis*.

The choice of species for culture is dependent on a number of factors including local availability, ease of maturation and reproduction in captivity, and growout characteristics in a given culture situation (such as nutritional requirements, stocking densities, survival and growth). As in other types of aquaculture, species differences require testing of different culture regimes and careful study of natural habitat. Of the species tested thus far, most attention in the Western Hemisphere has been focused on *P. stylirostris* and *P. vannamei* (both Pacific Ocean species ranging from Central Peru to Mexico), while *P. monodon* (eastern Africa to Japan) and *P. japonicus* (Mediterranean to Indo-West Pacific) have been the most popular candidates for mariculture outside the Western Hemisphere. More recently, *P. chinensis* has played a large role in the Eastern Hemisphere, and the Western Hemisphere has relied more heavily on *P. vannamei*.

Maturation

Research History

The general life cycle is similar for most all of the penaeids with spawning and early larval development in oceanic quality waters, and early postlarval stages to subadulthood in estuarine waters. A return to oceanic water precedes spawning. While the general life cycle of penaeids is similar, the particular environmental and nutritional parameters for each species may be quite different. A large body of work remains to be undertaken to define the optimal conditions for culture and in finding a substitute for the common practice of eyestalk ablation for captive spawn induction.

The late Dr. Motosaku Fujinaga (Hudinaga) made some of the most important contributions to the development of shrimp culture in 1934 when he first accomplished captive spawning of mature *P. japonicus* females and reared the resulting larvae to subadulthood (Hudinaga, 1942). The capture of wild females with mature ovaries for immediate spawning in captivity, which has become known as "sourcing," was the only method for inducing penaeid females to spawn in captivity for about 40 years, when induction of maturation and reproduction was applied through unilateral eyestalk ablation (several species were also matured without this hormonal manipulation).

The use of sourcing is still practiced in Japan today, with a total output of some 600 to 700 million postlarval shrimp annually. About 80 percent are used to restock coastal fisheries and the rest are used in commercial culture (Liao and Chao, 1983). Sourcing has also been used worldwide for experimental and commercial growout of numerous other species. This is particularly true for South-east Asia, where a single sourced *P. monodon* female (ready

to spawn) sells for \$500 or more. However, collection of females that are ready to spawn limits culturists to indigenous species that may or may not be the best or even a suitable culture species, and is dependent on seasonal availability, migratory movements, weather and natural rhythms. Efforts to induce penaeid reproduction in captivity continued so that a consistent, reliable source of postlarval shrimp (seedstock) could be obtained to support commercial culture operations, and the basis for genetic selection to develop ideal domestic stock with strong growth and survival characteristics could be established.

Other research of importance in maturation was done by Annie Laubier-Bonichon and L. Laubier at the Centre Oceanologique de Bretagne, in Brest, France. Later called the "Laubier method" of maturation, it involved maturation using temperature and photoperiod manipulation, without ablation of *P. japonicus* (Laubier-Bonichon and Laubier, 1976 and Laubier, 1978). The Laubier method was not successful for commercial operation. The French also made other important advances in shrimp maturation in the 1970s (Aquacop, 1975; Aquacop 1977a, 1977b, 1979, 1984 among others). Along with the French, the Southeast Asian Fisheries Development Center made some very important contributions to our present knowledge of maturation in the 1970s and 1980s (Primavera, 1978, 1979, 1985 and Primavera *et al.*, 1980). A good literature review of maturation and reproduction in penaeid shrimp appeared in Chamberlain *et al.*, 1985 and Primavera, 1985.

Maturation-Hatchery Research Highlights in the United States

Johnson and Fielding (1956) reported the first successful maturation and spawning (with fertilized eggs) of *P. setiferus* in the United States, but this was in ponds. A few years later, Cummings (1961) described maturation and spawning in the pink shrimp, *P. duorarum*.

The most significant contribution toward penaeid shrimp culture was made by the National Marine Fisheries Laboratory in Galveston, Texas. Research on the culture of larval shrimp started at the NMFS Galveston Laboratory in 1959 as part of an investigation into the life history of commercial shrimp in the Gulf of Mexico. Samples of plankton were taken in the Gulf to study the seasonal abundance of shrimp larvae of the commercial species. There was little information available about larvae of the different species and it was not possible to differentiate the commercial species from the non-commercial species. A project was started to collect gravid females of the various species, spawn them and culture the larvae so that specimens could be obtained for use in identification of larvae collected in the plankton samples. The research program on larval culture was successful and the Director of the Laboratory, Milton J. Lindner, was then instrumental in obtaining the funding necessary to develop the methodology into a prototype hatchery system.

This was the actual beginning of the development of the clearwater hatchery (intensive culture technique), called the Galveston technique by some. From this point it

passed through years of refinement and modifications by countless researchers and groups and is still being modified to meet the needs of individual hatcheries. Each following group "carried the ball" or "carried the torch" magnificently, helping the cause and spreading the knowledge. The most logical and the most accurate way to trace the refinement is through a published literature review.

1. Cook, H.L. 1965. Rearing and identifying shrimp larvae. U.S. Fish and Wildlife Service (U.S.F.W.S.) Circular No. 230.
2. Cook, H.L. and M.A. Murphy. 1966. Rearing penaeid shrimp from eggs to postlarvae. Proc. S.E. Assoc. of Game and Fish Comm.
3. Cook, H.L. 1966. Identification and culture of shrimp larvae. U.S.F.W.S. Circ.246.
4. Cook, H.L. 1966. A generic key to the protozoan, mysis, and postlarval stages of the Penaeidae. U.S.F.W.S. Bull. 65 (2):437-447.
5. Cook, H.L. 1967. Identification and culture of shrimp larvae. U.S.F.W.S. Circ.268.
6. Cook, H.L. 1968. Taxonomy and culture of shrimp larvae. U.S.F.W.S. Circ. 295.
7. Cook, H.L. 1969. Larval Culture. U.S.F.W.S. Circ. 325.
8. Cook, H.L. 1969. A method of rearing penaeid shrimp larvae. FAO Fish. Report No. 57, 3: 709-715. (Food and Agriculture Organization of the United Nations, Via delle Terme di Caracalla, 00100 Rome, Italy).
9. Cook, H.L., A. Brown, C.R. Mock and M.A. Murphy. 1970. Larval culture. U.S.F.W.S. Circ. 343.
10. Cook, H.L. and M.A. Murphy. 1969. The culture of larval penaeid shrimp. Trans. Am. Fish. Soc. 98 (4).
11. Cook, H.L. and M.A. Murphy. 1971. Early developmental stages of the brown shrimp reared in the NMFS Galveston Laboratory. Fish. Bull. 69 (1): 223-239.
12. Mock, C.R. and M.A. Murphy. 1971. Techniques for raising penaeid shrimp from the egg to postlarvae. Proc. World Maricul. Soc.

Many other publications followed and can be found in the reference sections of this manual or in List of NMFS Galveston Laboratory Publications and Reports Related to Marine Shrimp (*Penaeus* spp.) Aquaculture compiled by Maurice L. Renaud, Ph.D., Charles W. Caillouet, Ph.D., NMFS-SEFC Galveston Laboratory, 4700 Ave U. Galveston, Tex. 77550, or in Sindermann, C.J. (Ed.), 1987. NOAA Technical Report NMFS 47, Feb. 1987 entitled Reproduction, maturation and seed production of cultured species, Proceedings of the 12th U.S.-Japan meeting on Aquaculture, Baton Rouge, La., October 1983.

There were also other groups working on penaeid shrimp in addition to NMFS in the state of Texas. The Texas Parks and Wildlife Department and some of the universities published works on this subject in the 1960s. One example is J.J. Ewald's The laboratory rearing of pink shrimp, *P. duorarum*. (1965. Bull. Mar. Sc. Gulf and Caribb. 15(2):436-449).

Others who should be recognized for their work on penaeid shrimp in connection or in coordination with the NMFS Lab, either directly or indirectly, in a historical account are: Dave Aldrich, C. E. Wood, Neal Baxter, D. M. Allen, T.J. Costello, W.W. Anderson, J.E. King, W.C. Renfro,

R.H. Ridgon, C. Hanna, G.L. Beardsley, R.J. Berry, M.G. Kleve, D. Patlan, W.H. Clark, P. Talbot, B.R. Salsler, F.S. Conte, M.S. Duronslet, J.C. Parker, J.D. Corliss, Z.P. Zein-Eldin, J.M. Lyon, F. Marullo, A.I. Yudin, R.S. Wheeler, J.L. Fenucci, C.T. Fontaine, R.G. Bruss, I.A. Sanderson, S.E.P. Gislason, W.L. Trent, R.A. Neal, D.B. Revera, R.A. Gould, D. Grajcer, G.W. Griffith, L.A. Ross, E.F. Klima, J.H. Kutkuhn, L.M. Lansford, C.W. Caillouet, K.T. Marvin, A.L. Lawrence, D. Ward, S. Missler, J. McVey, B.S. Middleditch, J.K. Leong, D.H. Lewis, K. Hanks, R.R. Procter, A.K. Sparks, J.R. Adams, A.M. Heimpel, F. Marullo, R.C. Benton, M. Hines, E.S. Chang, J.L. Munro, D. Dimitriou, A.C. Jones, M.L. Parrack, J.C. Pearson, R.R. Proctor, R.C. Benton, R.H. Ridgon, R.D. Ringo, G. Zamora, M.A. Solangi, A.K. Sparks, D. Tave, R.F. Temple, F.W. Weymouth, J.M. Fox, J. Wilkenfeld, Linda Smith, and numerous others.

Selected examples from the literature are:

1. Sparks, A.K. and E.F. Klima. 1965. Effects of injected biological stains on oxygen uptake by shrimp. *Trans. Am. Fish. Soc.* 94(3): 277-278.
2. Brown, A. and G. Patlan. 1974. Color changes in the ovaries of penaeid shrimp as a determinant of their maturity. *Marine Fisheries Review*, Vol. 36:7 p.23-26.
3. Klima, E.F. 1978. Aquaculture research in the Galveston Laboratory. *WMS* 9. (Also NMFS Contrib. #78-156).
4. Duronslet, M., A.I. Yudin, R.S. Wheeler and W.H. Clark, Jr., 1975. Light and fine structural studies of natural and artificially induced egg growth of penaeid shrimp. *Proc. World Maricult. Soc.*, 6:105-122.
5. Brown, A., J. McVey, *et al.*, 1979. Maturation of white shrimp (*P. setiferus*) in captivity. *WMS* 10:435-444.
6. Brown, A., J. McVey, *et al.*, 1980. The maturation and spawning of *P. stylirostris* under controlled laboratory conditions. *WMS* 11: 488-499.
7. Lawrence, A.L., D. Ward, S. Missler, A. Brown, J. McVey and B.S. Middleditch. 1979. Organ indices and biochemical levels of ova from penaeid shrimp maintained in captivity versus those captured in the wild. *WMS* 10:453-463.
8. Middleditch, B.S., S.R. Missler, D.G. Ward, J.P. McVey, A. Brown, and A.L. Lawrence. 1979. Maturation of penaeid shrimp: dietary fatty acids. *WMS* 10:472-488.
9. McVey, J.P. 1980. Current developments in the penaeid shrimp culture industry. *Aquaculture Magazine* 6(5):20-25.
10. Middleditch, B.S., S.R. Missler, M. Hines, J.P. McVey, A. Brown, D.G. Ward and A.L. Lawrence. 1980. Metabolic profiles of penaeid shrimp: dietary lipids and ovarion maturation. *J. Chromatography* 195:359-368.
11. Middleditch, B.S., S.R. Missler, M. Hines, J.P. McVey, A. Brown, and A.L. Lawrence. 1980. Maturation of penaeid shrimp: lipids in the marine food web. *WMS* 11:463-470.
12. McVey, J.P., 1983. *Handbook of Mariculture*, Vol. I. Crustacean Aquaculture, CRC Press Inc., Boca Raton, FL. 442 pages. (Update is expected to be published in 1993).

The Galveston Laboratory continued to refine maturation, hatching and larval-rearing methods throughout the

1970s and served as an important demonstration and training center for maturation-hatchery biologists worldwide. The methods utilized by the NMFS researchers are still widely known as the intensive method or "the Galveston Laboratory Technique" (Klima, 1978; Mock *et al.*, 1980; McVey, 1983). The methods used and described in this manual are basically modifications of this intensive method of culturing larvae. Research at Texas A&M University continued along these lines in the 1980s (Lawrence *et al.*, 1980; Chamberlain and Gervais, 1984; Robertson *et al.*, 1987a; among others), as well as similar research at other institutions such as the University of Miami (Yang, 1975) and the Oceanic Institute (Wyban *et al.*, 1987, Wyban *et al.*, 1988 and Oyama *et al.*, 1988 among others).

Important Parameters for Maturation

The most important parameters for successful maturation of penaeid shrimp are constant temperature, salinity, pH, light, and good nutrition. The object is to reproduce the near constant conditions found in the deeper oceans. Constancy is a must. Clear pristine, oceanic quality sea water is the key to successful maturation.

Salinity	Temperature	pH	Light	D.O.
28-36ppt	27-29°C	8.0-8.2	14L,10 D	5ppm+
	Allowable ranges/24 hours			
+/-0.5ppt/Day	+/-0.5°C/Day	+/-0.2/Day		

1. **Temperature**—optimums are 27 to 29° C for most warm water species. The senior author feels that a minimum of 28° C is required for *P. vannamei*, but 26° C is sufficient for *P. stylirostris*. *P. monodon* will do best at 28° C. A 0.5° C temperature fluctuation over a 24-hour period is allowable. As much as +/- 2° C has been experienced under commercial conditions by senior author with *P. monodon* with no serious noticeable effects.
2. **Salinity**—optimum is oceanic (35ppt). Although maturation may occur at a lower or higher salinity (28-36), normal oceanic salinities are considered to be 35ppt. Again constancy is important. If the salinity is low in the hatchery area it is generally not a good idea to add salt and trace metals if the difference is more than 5ppt. If artificial sea salts are used, then the best artificial sea salt brand is Hawaiian Marine. One can save costs by using Morton's Salt (table salt quality; rock salt is cheaper but has many impurities) and buying trace metals separate. Fritz "Supersalts" is another brand of trace metals. Salinities below 30ppt would be unlikely treatable for maturation use. Likewise, salinities above 40ppt should be avoided because fresh water dilution may also interfere with trace metal balances essential for maturation and high animal health.
3. **pH**— optimum 8.0-8.2. Normal sea water or average sea water pH is considered to be 8.0. This can vary +/- 0.2 depending upon the location. If the pH is lower than 7.8 or higher than 8.2, the site should be avoided. Any addition of buffers or acids may interfere with the trace metal balance and chemical reactions in sea water and should be avoided unless absolutely nec-

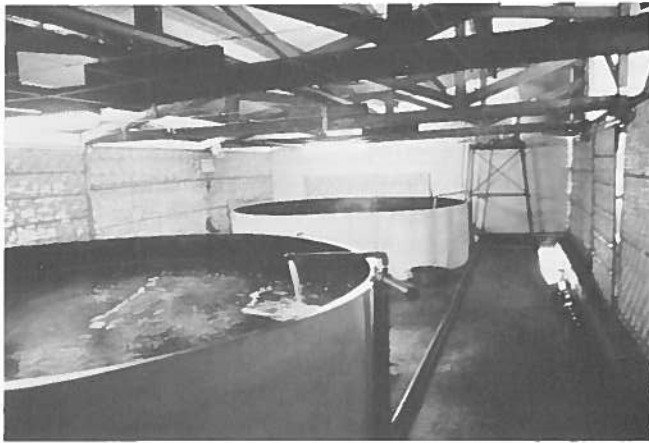

Photo 27. Maturation room (note low light level).

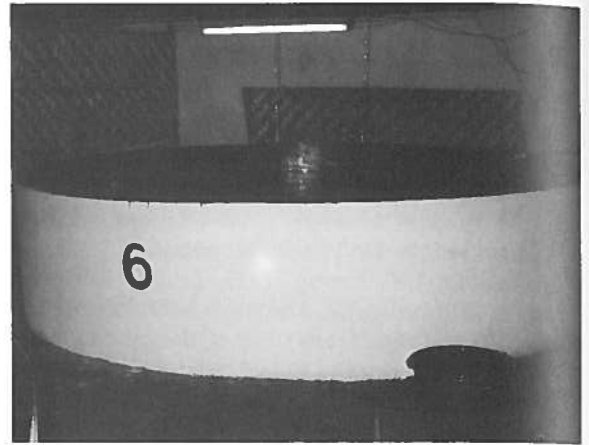

Photo 28. Maturation tank (400 cm in diameter constructed of Ferro cement, painted black on inside).

essary. Some adjustments have been reported to maintain pH/alkalinity levels by using sodium hydroxide and/or calcium carbonate.

4. **Light**— dim light, with approximately 14 hours light and 10 hours dark is sufficient. The light cycle should be longer than the dark. Ablated animals reproduce in a wide variety of light regimes (Photo 27).
5. **Nutrition**— one of the most important aspects in sustaining a good maturation program is nutrition. Most everyone agrees that a combination diet works best. Some believe that bloodworms are essential for *P. vannamei*. There is no question that the animals prefer this food over others and become very excited when worms are placed in the tank. The source of the food needs to be carefully considered. Squid is most often used for both *P. vannamei* and *P. monodon* maturation programs. Some say that Gulf of Mexico-caught squid carry Rickettsia (a microbe with similarity to both viruses and bacteria) and would infect the shrimp if used for feed. Squid is relatively easy to obtain and inexpensive in comparison to bloodworms. Bloodworms cannot be imported into the United States without having been processed in some manner. For example, if they are mixed with oysters and called maturation food then they are considered a processed product and can be purchased from Panama. The best source for bloodworms in the United States Eastern Bait Co. (Stetson Everett) Box 55, Hancock, Maine, U.S.A. 04640, telephone (207) 422-6822. They can be purchased live or frozen (1 1/4 lb. bag = \$US 30).

Other Parameters to Consider

- a. Nitrogen ammonia levels should be non-existent. Normal sea water nitrogen is 0.02-0.02 mg/1 NH₄-N; 0.01-0.04 mg/1 NO₂-N and 0.1 mg/1 NO₃-N.
- b. Water should be on a flow-through system or good recirculated system to keep metabolic wastes and food by-products from building up in the tank.
- c. Total suspended solids, organics, brown or red tide, bacteria and other items in the incoming water. Most suspended solids and organics should be removed during settling and slow sand filtration. Organics do not appear to pose a problem in flow-through systems

but do in closed or semi-closed systems. Food by-products, feces, eggs, etc., all provide substrate for bacteria, fungi, and protozoans to thrive. Brown tide and/or red tide can also become an occasional problem for the hatchery. If it is not economically practical to use carbon filters to remove these unwanted dinoflagulates, then chlorination may become necessary. Depending upon the organic load, normally 2 to 8ppm chlorine treatment overnight is sufficient to kill dinoflagulates and even bacteria in the sea water. The treated sea water should be vigorously aerated to neutralize the chlorine. Extreme caution should be exercised if chlorine is used. Chlorine can form chromines and/or other by-product in sea water as a result of chemical reactions with trace metals. The chromines could cause problems (if not toxic then they could cause stress to the animals and stop maturation). Chlorine can also be neutralized by sodium thiosulfate in a 1:3 to 1:6 ratio (1 part thiosulfate to 6 parts chlorine) but thiosulfate has been found to cause deformities in shrimp larvae and it would be reasonable to assume maturation and mating could be affected by a trace metal imbalance caused by the addition of yet another chemical such as thiosulfate. Thiosulfate additions have caused *P. monodon* broodstock deaths in India (personal communication with Mike Yates and Josh Wilkenfeld).

Additional Considerations for Optimum Maturation

- a. Tank Color - Black, because animals see it better and seem to be more comfortable and at rest in a darker environment (Photo 28).
- b. Noise - level should be kept low. All machinery, large air bubbles or any human activity which would stress or disturb the shrimp should not be allowed.
- c. Obstructions - in the maturation tank should be kept to a minimum (stand pipes, hoses, tubes, water inlets, air lifes, etc.). These interfere with swimming and mating and with capturing the mated shrimp with a net. Obstructions outside the tank (pipes on the floor, etc.) should also be avoided for the safety of the workers.
- d. Nets - soft with small mesh so as not to damage the animals during handling.

- e. Vacuum head - a large swimming pool vacuum head should be used with 1 1/2" to 2" flexible hose when vacuuming the tank. Most vacuum heads ride on rollers a set distance from the bottom and have a strong vacuum capability to clean the tank rapidly without injuring the animals. Larger pieces of squid, molts etc. can be removed during the cleaning routine.
- f. Eye tags - some hatcheries use bird bands from the National Band & Tag Company or rubber tubing (placed over the shrimp eye on the eye stalks to mark the shrimp). Nostril expanders can be used to stretch the rubber bands. Other hatcheries simply cut a portion of the shrimp's uropod off (or knotch it to mark the shrimp when marking is needed).

Sources of Broodstock (Bray *et al.*, 1991)

There are three ways to spawn penaeid shrimp: acquire mated females (sperm-bearing) with mature ovaries from the wild for immediate spawning in captivity; acquire adults from the wild to induce gonadal development, mating and spawning in captivity; and induce gonadal development, mating and spawning in adults that have been reared completely in captivity in ponds or other culture vessels. The first method, collection of wild-matured, mated females in nature, produces high quality eggs and larvae. This is probably due to adults having been exposed only to their natural diet and environmental conditions. However, this method has a number of disadvantages, including the inability to work with non-indigenous species, seasonal availability of mature adults, expense of operating an offshore vessel, inconsistency of weather, migratory movements of the populations, and variations in reproductive activity within the breeding season. This method of obtaining mature adults for immediate spawning in captivity has been widely used for years in Japan, where the acquisition of live adult females was greatly simplified by existence of a commercial fishery for live adult shrimp. In most fisheries, shrimp are trawled and headed on board the vessel, and the vessels have no holding systems for live transportation. The method of wild collection of gravid females has been practiced commercially in Southeast Asia with *P. monodon*, on a limited basis in the United States with *P. setiferus*, and in Central and South America with *P. vannamei* and *P. stylirostris*. Sourcing has also been used for experimental purposes with numerous species worldwide.

Sourcing *P. monodon* in Indonesia

Hatchery experience in Central Java has indicated that during the months of April through September it is quite easy to obtain not only mature-sized females and males, but also mated females from local waters (Java Sea). Broodstock are usually sold to hatcheries by local bagan (fishing platform) fishermen who bring their catch directly to the Yayasan Dian Desa Hatchery. In the past, transport methodology was quite crude and on numerous occasions broodstock had to be rejected due to handling stress incurred in holding and transfer of the animals from the ocean to the hatchery. Typically, no aeration is used and the shrimp are sometimes kept for several hours in shallow plastic buckets in the fishing boat. More recent

advancements include the use of portable aeration devices and frequent exchange of water in the holding buckets. Fishermen who sell broodstock have quickly learned to associate themselves with a small group of hatcheries and to identify which facilities are in need of broodstock. In 1987, the average price of large males (greater than 200g) was about Rp. 2,500 (1000 rupiah = U.S. \$1.17). Females command a higher price, the price varying according to size and whether the shrimp is mated or not. The average price for an average-size mated female was about Rp. 8,000. (U.S. \$9.36). This contrasts sharply with reports from Taiwan where mated females can bring as much as U.S. \$600. Upon arrival at the hatchery, the broodstock that have been bought from the fishermen are quarantined for diagnosis of (MBV) *monodon baculovirus*. If they are clear of the virus, then the animals are ablated (if female) and stocked into maturation tanks.

External Characteristics of Adult Penaeid Shrimp (Treece and Yates, 1990)

A penaeid shrimp is covered with a protective exoskeleton and has jointed appendages. Most organs are located in the anterior end (head), sometimes called the cephalothorax. The muscles are found in the tail or abdomen. The external body parts listed in both Figures 21 and 22 are apparent upon examination of an adult shrimp and are most often referred to in a shrimp identification key. References on shrimp identification are Farfante, 1969; Bielsa *et al.*, 1983; Holthius, 1980; Farfante, 1988; Yu and Chan; 1986; Dore and Frimodt; 1987; Cordover and Brick, 1972; Dall, 1957; Kow, 1968; Racek, 1970; and Tirmizi and Bashir, 1973.

General Reproductive Characteristics

Penaeid shrimp can be grouped into two broad categories, the open-thelycum (or white shrimp) and closed-thelycum (or brown shrimp) species. There are a few exceptions to this (e.g. *P. indicus* is considered a white shrimp but has closed-thelycum). The open-thelycum species are five members of the genus *Penaeus*, subgenus *Litopenaeus*, indigenous only to the Western Hemisphere (*P. setiferus* and *P. schmitti* in the Atlantic Ocean; *P. stylirostris*, *P. vannamei* and *P. occidentalis* in the Pacific). While the open-thelycum shrimp follow the sequence of molt-mature-mate-spawn, the closed-thelycum shrimp follow the sequence of molt-mate-mature-spawn.

Male Reproductive System (Motoh, 1981)

The male genital system consists of internal organs: paired testes, paired vas deferens, paired terminal ampoules, and external organs: a petasma and a pair of appendix masculina.

The testes, an unpigmented and translucent organ, is composed of an anterior and five lateral lobes located in the cardiac region dorsal to the hepatopancreas under the carapace. The lobes are connected to each other at their inner ends and lead to the next organ, the vas deferens. The vas deferens arises from the posterior margins of the main axis of the testes and opens to the exterior through genital pores located medially on the coxopod of the fifth

Figure 21. Lateral View of Adult Female *Penaeus setiferus*
(From Young, 1959)

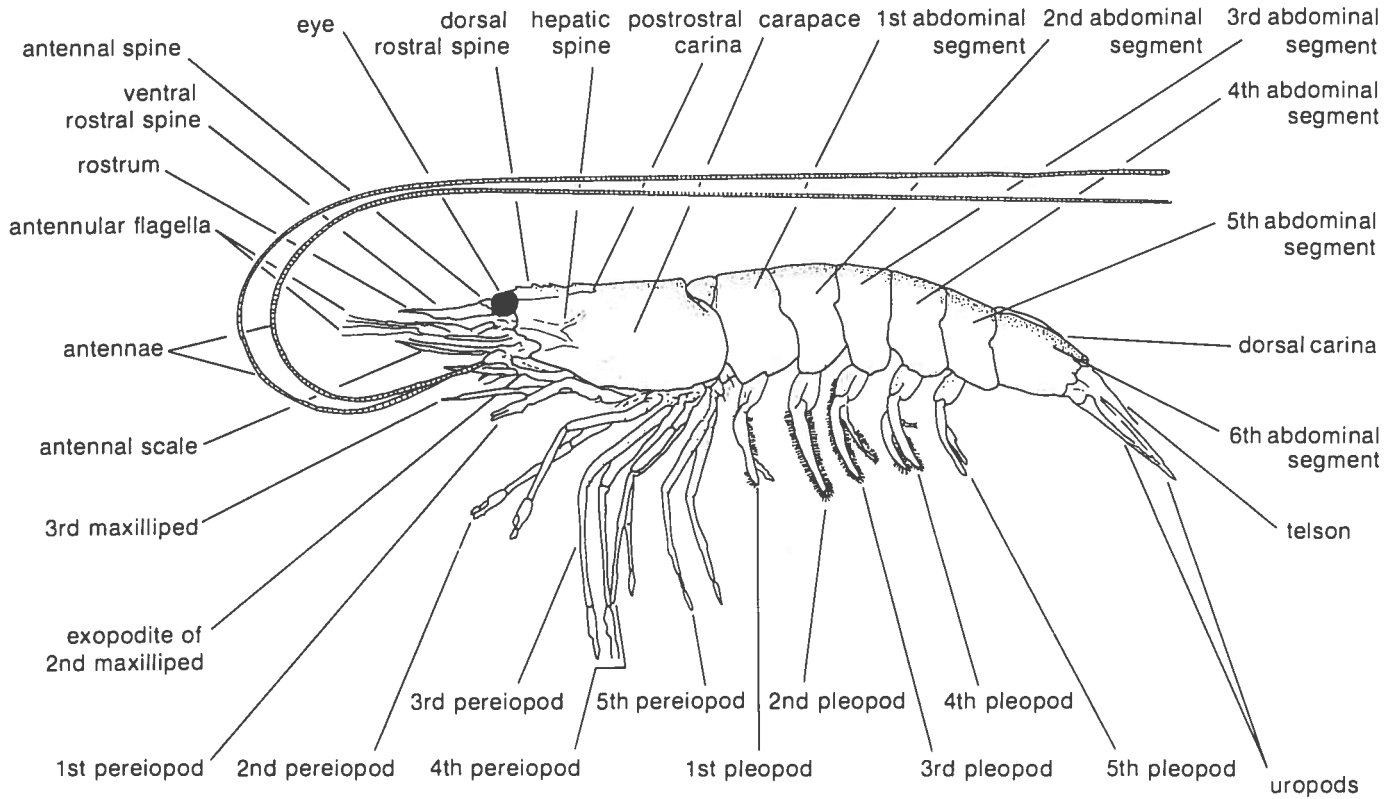

Figure 22. Dorsal View of Adult Shrimp
(From Young, 1959)

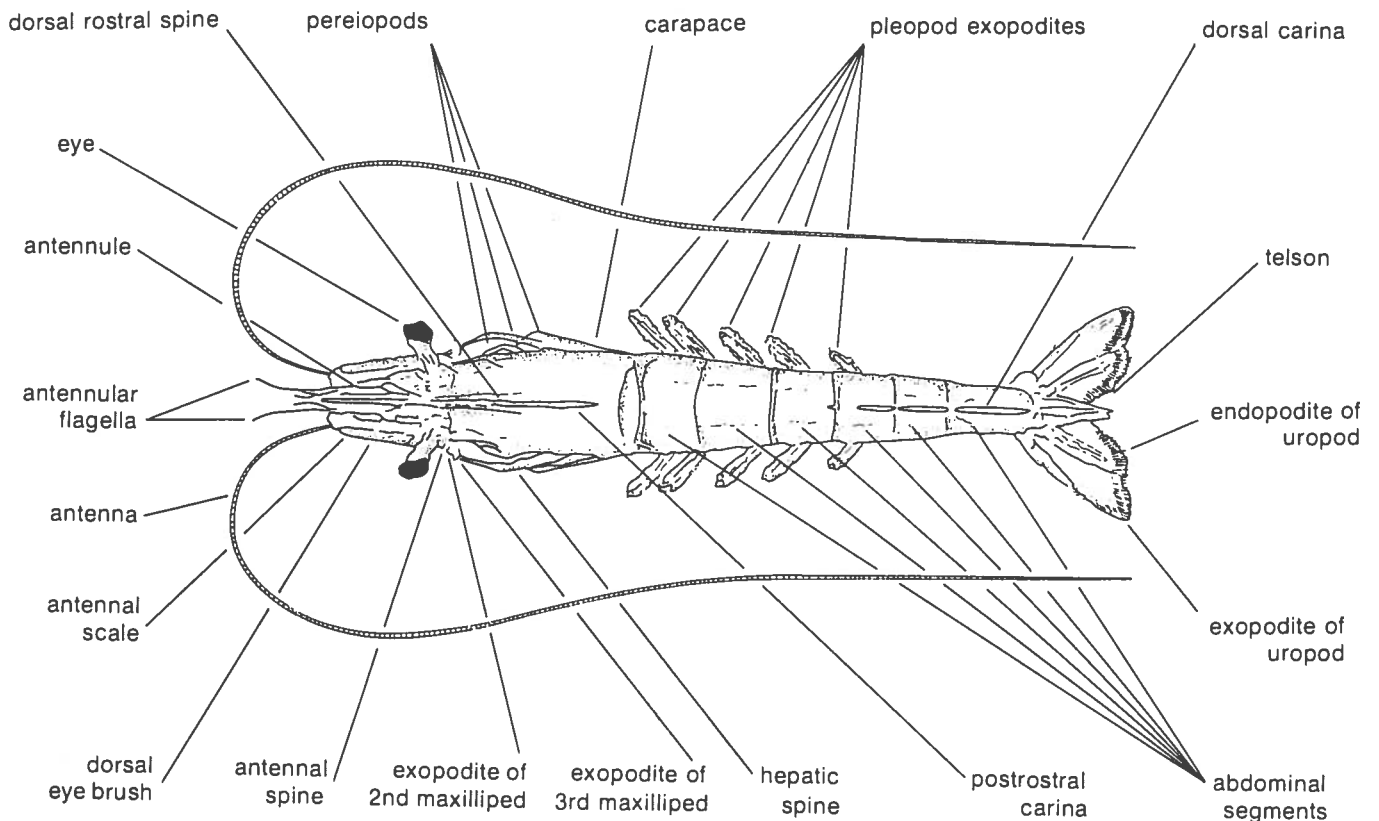
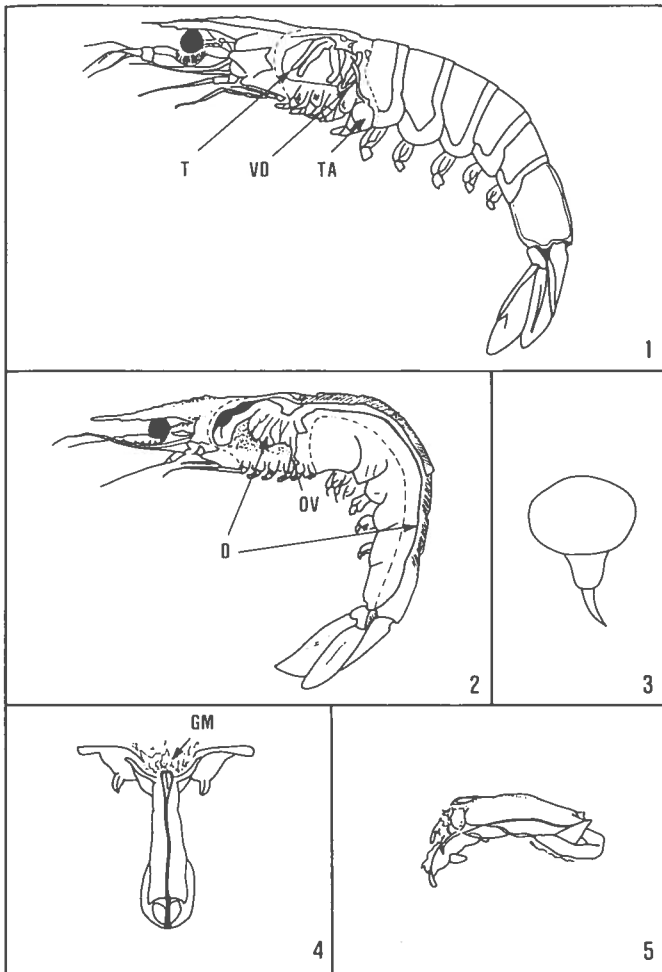
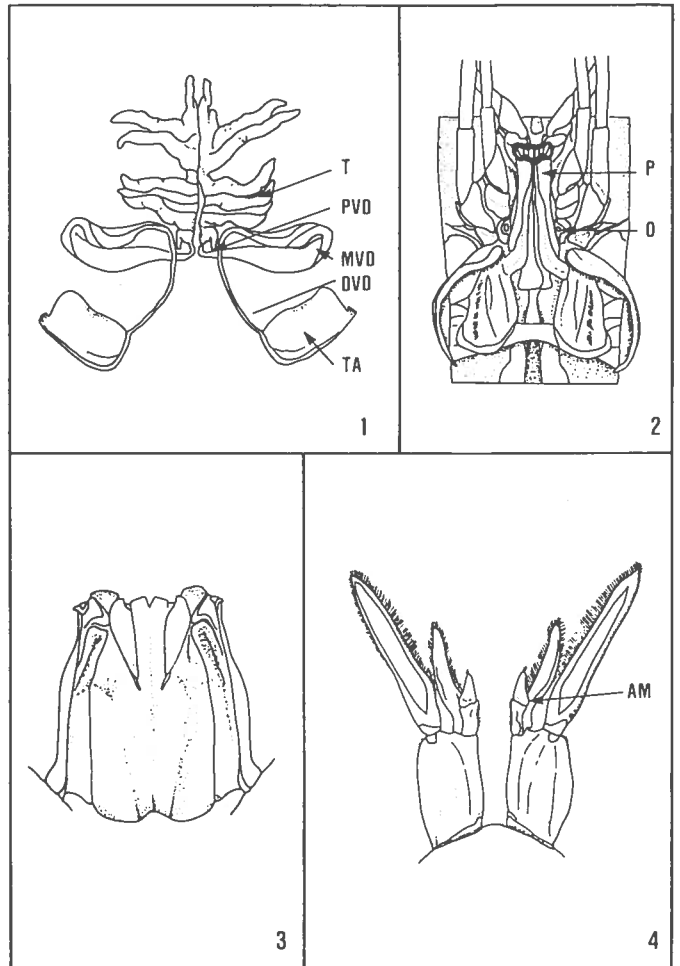

Figure 23. Details of Male and Female Reproductive System (open thelycum type or non-grooved shrimp) (King, 1948)



1. Diagram of male, lateral view, dissected to show reproductive organs. T-testis; VD-vas deferens; TA-terminal ampoule. $\times 0.5$.
2. Diagram of female, lateral view, dissected to show relationship of ovary and oviduct. O-ovary; OV-oviduct; $\times 0.5$.
3. Diagram of shrimp spermatozoan. $\times 9000$ (approx.)
4. Diagram of ventral view of spermatophore (as in attached position). GM-gelatinous material. $\times 2.75$.
5. Diagram of lateral view of spermatophore. $\times 2.75$.

Figure 24. Details of Male Shrimp Reproductive System (white shrimp) (King, 1948)

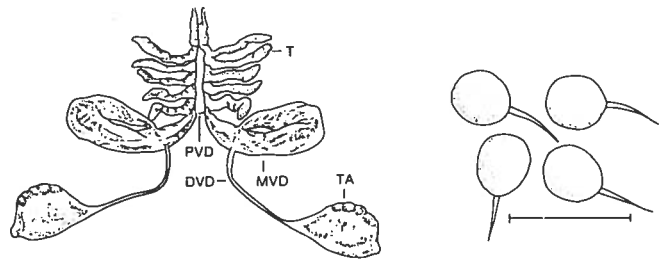

1. Diagram of male reproductive system. T-testis; PVD-proximal vas deferens; MVD-medial vas deferens; DVD-distal vas deferens; TA-terminal ampoule. $\times 1.75$
2. Diagram of ventral surface of mature male. P-petasma; O-opening of vas deferens. $\times 1.75$.
3. Diagram of petasma of mature male spread open to show interior arrangement of folds. $\times 2.9$.
4. Diagram of second pair of pleopods of male. AM-appendix musculina. $\times 1.75$.

Figure 25. Male Reproductive System
(*Penaeus monodon*)

1. Male reproductive system of *P. monodon*. T, testis; PVD, proximal vas deferens; MVD, medial vas deferens; DVD, distal vas deferens; TA, terminal ampoule.

2. Spermatozoa of *P. monodon*. Scale represents 5 microns

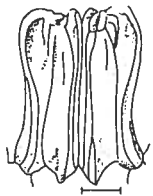

3. Petasma of *P. monodon*. Scale represents 0.2 mm.

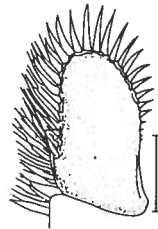

4. Appendix masculina of male *P. monodon*. Scale represents 1 mm

(as described by Motosh, 1981)

pereiopod (Figures 23 and 24). Each vas deferens consists of four distinct portions: a short, narrow, proximal medial portion having a double fixture (medial vas deferens); a relatively long narrow tube (distal vas deferens); and a muscular portion (terminal ampoule).

The terminal ampoule, a bulbous structure, possesses a thick muscular wall lined with extremely tall columnar epithelial cells. It has two internal chambers; one contains the spermatophores and the other contains calcareous material of a slightly gray color. The paired terminal ampoules open at the base of the coxopod of the fifth pereiopods. The spermatozoan, a minute globular body, is composed of two parts: head and tail (Figures 23-3 and 25-2). The head is large, almost circular in outline and about 3 microns in diameter, while the tail is relatively thick and short. Although it is logical to assume that the spermatozoan is capable of movement, it has never been observed.

The petasma is a pair of endopods of the first pleopods. It is formed by the interlocking of minute hook-like structures (Figures 24-3 and 25-3).

The shape of the appendix masculina (Figure 24-4), which is located on the endopod of the second pleopod, is generally oval in shape for *P. monodon* (Figure 25-4).

The spermatophores, one from each terminal ampoule, become fixed together longitudinally at time of extrusion and are then referred to as the "compound spermatophore."

Spermatophore structures vary considerably among closed-thelycum and open-thelycum shrimp, but mating and courtship rituals are similar within each group. Spermatophores among the open-thelycum shrimp are quite complicated (Figures 23-4 and 23-5).

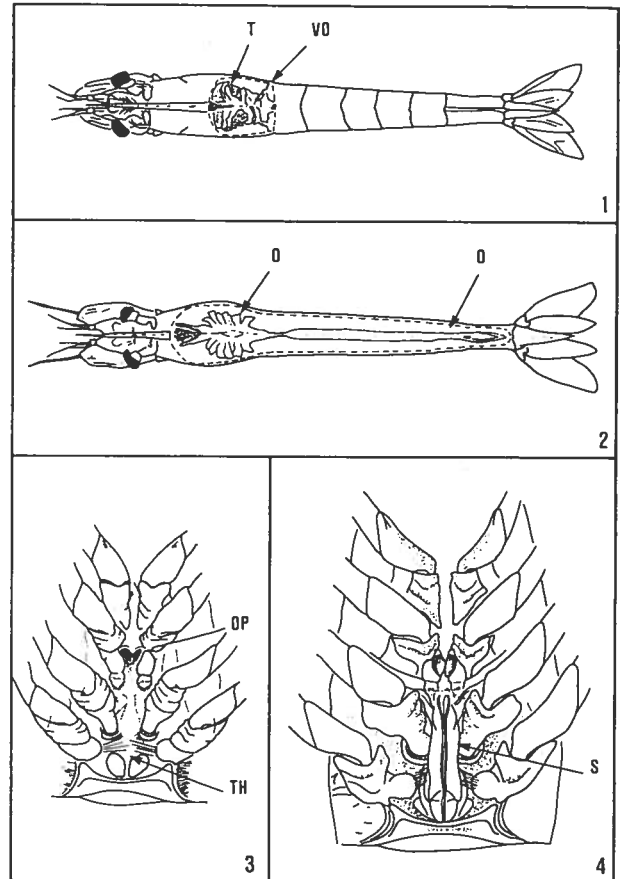
Figure 26. Details of Male and Female Reproductive System
(open thelycum type or non-grooved shrimp)
(King, 1948)

1. Diagram of male, dorsal view, dissected to show testes and portions of vasa deferentia. T-testis; VD-vas deferens. $\times 0.5$.
2. Diagram of female, dorsal view, dissected to show ovaries. O-ovary. $\times 0.5$.
3. Diagram of ventral surface of cephalothorax of female. OP-opening of oviduct; TH-thelycum. $\times 2.5$.
4. Diagram of ventral surface of cephalothorax of female with spermatophore attached. S-spermatophore. $\times 2.5$.

Female Reproductive System (Motosh, 1981)





















































The female reproductive system consists of paired ovaries, paired oviducts and a single thelycum; the first two are internal and the last is an external organ. The ovaries are partly fused, bilaterally symmetrical bodies extending in the mature female for almost its entire length, from the cardiac region of the stomach to the anterior portion of the telson (Figure 26-2). In the cephalothoracic region the organ bears a slender anterior lobe and five to six finger-like lateral projections. A pair of lobes, one from each ovary, extends over the length of the abdomen. The anterior lobes lie close to the esophagus and cardiac region of the stomach. The lateral lobes are located dorsally in the large mass of the hepatopancreas and ventrally in the pericardiac chamber. The abdominal extensions lie dorso-lateral to the intestine and ventro-lateral to the dorsal abdominal artery.

The oviducts originate at the tips of the sixth lateral lobes and descend to the external genital apertures hidden in the ear-like lobes of the coxopods of the third pair of pereiopods (see Figure 26-3 for opening of oviduct).

The thelycum is located between a pair of the fifth pleopods and consists of an anterior and a pair of lateral plates (Figure 26-3). Note the variation of the thelycum on

Figure 27.

"Quick" Identification of Selected Species

PENAEID SPECIES	Closed Thelycum	Teeth on Rostrum (Mode)	Shape of Rostrum and Location of Teeth	1st Antennae	Thelycum ♀	Petasma ♂	Other Characteristics
<i>P. occidentalis</i>	no	$\frac{9-12}{3-5}$ (9/4)					Rostrum curves upward and species is easily confused with <i>P. stylirostris</i> . It has only one spot on ventral portion of tail. "Western White Shrimp"
<i>P. stylirostris</i>	no	$\frac{7-8}{3-6}$ (7/4-5)					Blueish pereopods (walking legs). 2 spots on tail (one ventral, one dorsal) "Blue Shrimp"
<i>P. vannamei</i>	no	$\frac{8-9}{1-2}$ (8/2)					Surface of carapace is not as smooth as the other sp. when young. Red antennae. No coloration on telson, uropod region. "Whiteleg"
<i>P. setiferus</i>	no	$\frac{4-10}{0-3}$ (8/2)					Black coloration on telson, uropods. Rostrum long, slender, sometimes turning up. Ventral teeth apart. "Northern White"
<i>P. schmitti</i>	no	$\frac{7-10}{1-3}$ (8/2)					Petasma without diagonal crestion inner surface of distal part of lateral lobe. Thelycum has parallel crests. "Southern White"
<i>P. duorarum</i>	yes	$\frac{7-10}{1-3}$ (8/2)					Dorsolateral grooves of sixth abdominal somite narrow. "Northern Pink"
<i>P. aztecus</i>	yes	$\frac{5-10}{0-3}$ (8/2)					Median groove of postrostral carina long and deep. Dorsolateral grooves broad. "Northern Brown"
<i>P. brasiliensis</i>	yes	$\frac{7-11}{0-3}$ (8/2)					Petasma with long projections and distal folds which penetrate deeply into petasma. "Red Spotted"
<i>P. californiensis</i>	yes	$\frac{8-9}{2}$					Saddle-like structure on posterior portion of 3rd abdominal segment and anterior part of 4th segment rostrum straight. Exterior coffee colored (dorsal posterior and ventral) "Yellowleg"
<i>P. brevisrostris</i>	yes	$\frac{8-10}{2-3}$					Last ventral tooth anterior to or on same level as first dorsal tooth. No longitudinal carina on thelycum. Dark pink. "Crystal Shrimp"
<i>P. monodon</i>	yes	$\frac{7}{2-3}$ (7/2)					Groove (rostral) is shorter than in <i>P. semisulcatus</i> . "Giant Tiger"
<i>P. semisulcatus</i>	yes	$\frac{7}{2-3}$					Multi-colored shrimp. (blue, red, yellow on swimmerets). Banded antenna (dark, light) "Green Tiger"
<i>P. indicus</i>	yes	$\frac{5-7}{0-1}$					Gastrorbital carina posterior 2/3 hepatic spine and orbital angle. Rostral crest high. "Indian White"

different species in Figure 27 ("Quick" Identification of Selected Species).

Size at First Maturity and Mating (Primavera, 1985)

In a male *P. monodon*, the presence of identifiable sperm by microscopic examination of dissected spermatophores indicates sexual maturity. Both pond and wild *P. monodon* of 40g body weight are already sexually mature.

Females are mature when they develop Stage III or IV ovaries (see Figure 28). However, unlike the males, they rarely attain maturity in captivity unless they undergo eyestalk ablation. Individual records of wild gravid females caught in the Philippines and subsequently spawned in SEAFDEC hatcheries show an average body weight of 142g with minimum of 87g and a maximum of 206g.

Although they are capable of full ovarian maturation only when they reach about 90g body weight, wild *P. monodon* females actually mate when they are smaller. Sperm has been identified in the dissected thelyca of wild females with a minimum body weight of 63g. More interesting are observations on pond-reared stock: a female weighing less than 40g was found to be positive for sperm. The fact that females with very little chance of full maturation of the ovaries and later of spawning in the ponds mate regularly proves that maturation and mating are two independent events in *P. monodon*. Moreover, the smaller size of the pond-mated females compared to the wild stock could be due to a higher stocking density in the ponds affording greater opportunities for males and females to mate or stunted growth of mature-aged females.

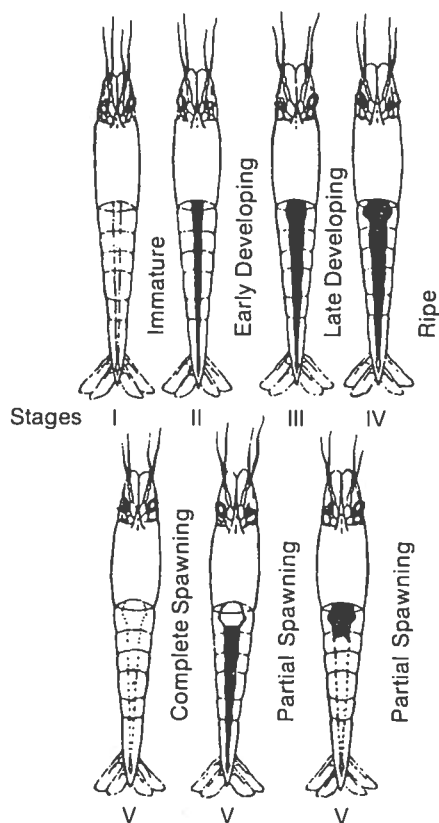

Figure 28. External appearance of the ovaries of *P. monodon* at different stages of maturity as seen through the dorsal exoskeleton. (from Primavera, 1985).

Ovarian Maturation/Staging Mature Shrimp (Primavera, 1985)

The different maturation stages for both ablated and wild females are the following:

Stage I (Immature) — Ovaries are thin, transparent and not visible through the dorsal exoskeleton. On dissection they appear as colorless strands of tissue, devoid of visible eggs.

Stage II (Early maturing) — Ovaries observed as thin, linear band through the exoskeleton as they start to increase in size, particularly in the anterior and middle lobes. Color of dissected ovaries ranges from cloudy-white to light-brown and grayish-green.

Stage III (Late maturing) — Ovaries visible through the exoskeleton as a thick, solid, linear band as they considerably expand from the anterior thoracic to the posterior abdominal region. Dissected ovaries are mostly light olive-green and firm and granular in texture with clumps of eggs that can be seen.

Stage IV (Mature or ripe) — Ovaries exhibit a diamond-shaped expansion at the forward abdominal region and the linear band is thicker. Upon dissection, they appear dark olive green and are so distended they fill up all available space in the body cavity.

Stage V (Spent) — Completely spent ovaries are limp, thin and outwardly appear similar to Stage I (immature)

ovaries. Dissected ovaries are yellowish but become more and more white as regression continues.

Several observations can be made concerning staging (see Figure 28). The final flush of color or rapid change in color associated with spawning seems to occur within hours of spawning. Also, there is considerable difference in ovarian color among species (for example, a bronze color in *P. stylirostris* as opposed to yellow-orange to drab in *P. setiferus*). Additionally, the closed-thelycum species develop as light-green and then olive-green ovaries.

Under captive conditions, particularly over time, different ovary colors are frequently seen. The fullness of ovaries at Stage IV is often only a percentage of the full ovaries of wild animals. There is frequently a separation between ova-filled lobes in the carapace and abdomen, and in some species (e.g. *P. vannamei*), only the anterior lobes may develop in captivity. Diet and light have been suggested as explanations for ovarian color differences in captivity. Unablated *P. indicus* females in white and black tanks generally took on a color more similar to the background tank color, as did their ovaries, eggs and nauplii. White-tank females developed pale-green to cream-colored ovaries, while black tank females developed dark-olive ovaries.

Ovary color, although varying from the wild state, can be fairly dependable as a staging determinant in *P. vannamei* and *P. stylirostris*. The size of the gonad in the first thoracic segment, compression of the posterior cephalic lobes observed at the thoracic abdominal junction, and a "granular" texture, must be used as determinants of immediate spawning in *P. monodon*, *P. merguensis* and *P. japonicus*. Of course, in open-thelycum species, the presence of a spermatophore, spermatophore portion, or sperm mass, is also an obvious indication of readiness to spawn. All of these judgments, except the latter, are subjective judgments guided by experience.

The Shrimp Egg (Chamberlain *et al.*, 1985)

Oogonia are continually produced mitotically from germinal epithelium throughout the reproductive life of the female. Oogonia enter meiosis, differentiate into oocytes, begin yolk synthesis and become surrounded by follicular cells. Yolk deposition proceeds slowly during primary vitellogenesis but accelerates during secondary vitellogenesis when yolk material apparently is pinocytotically drawn from the hemolymph through the blanket of follicular cells into the oocyte without any major change.

The chief component of crustacean egg yolk is a high density lipoglycoprotein, termed crustacean lipovitellin, which contains 27 to 35 percent lipid, a small carbohydrate component and no protein-bound phosphorus. The lipid component consists largely of phospholipids (usually containing high-levels of medium length, monounsaturated fatty acids), a carotenoid and small quantities of cholesterol and triglycerides. Most of the nutrients are drawn from immediate food intake.

Development of different egg types of *P. monodon* can be seen in Figure 29. The types of development can be used to set criteria for "save or discard" decisions in the commercial hatchery.

Figure 29.

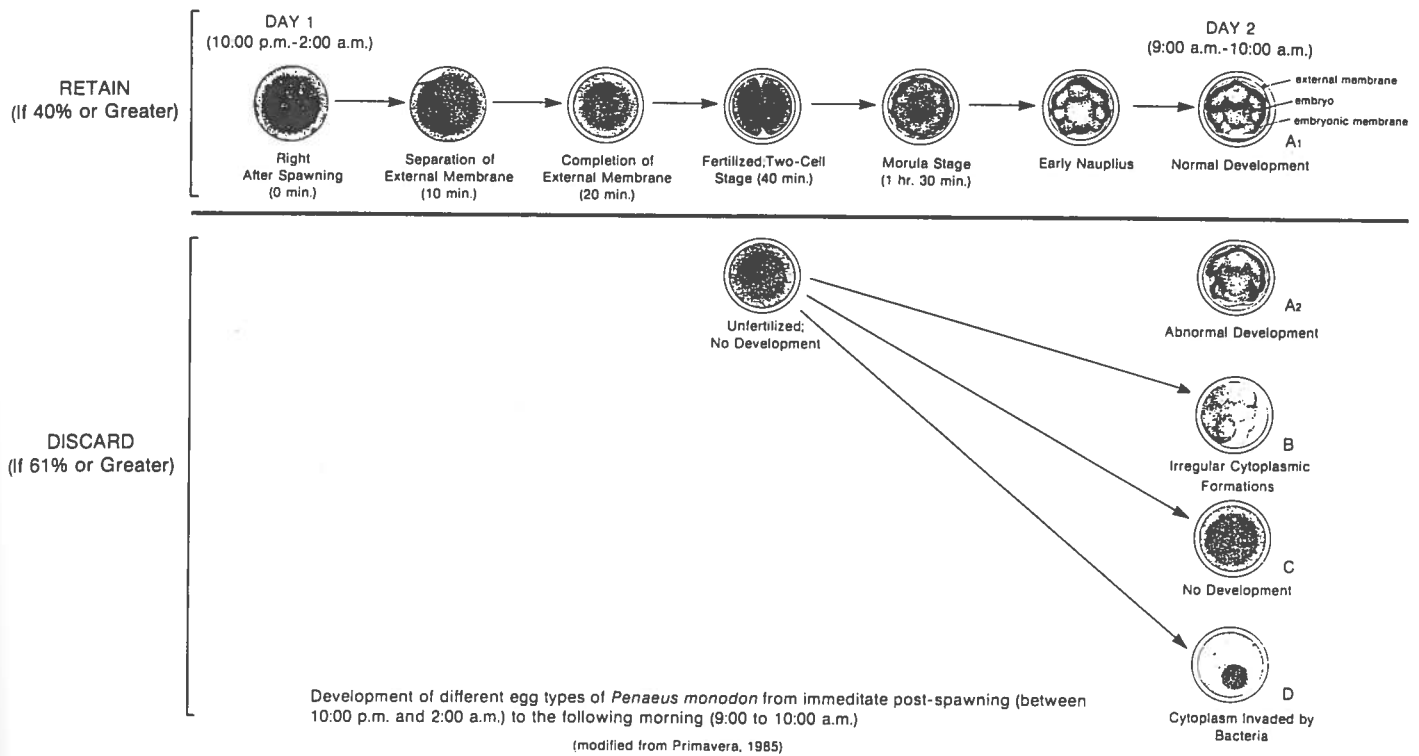

Mating of Open-Thelycum Shrimp

In the open-thelycum species, a male with hardened exoskeleton mates with a mature female (also hardened) only late in the day. The male deposits a complex sperm packet (Figures 23-4 and 23-5) onto the ventral surface of the female between the third and fifth pereopods (Figure 26-4). The sperm is extruded from the spermatophore prior to spawning, and eggs are fertilized during the actual several minute spawning period.

Mating in open-thelycum shrimp is also characterized by male attraction to a female, a courtship ritual of parallel swimming (Figure 30-1) and placement of spermatophores after achieving a 90-degree rotation (Figure 30-4) that places the male below and perpendicular to the female. "Chasing," the initial phase of sexual behavior, occurs somewhat randomly, occasionally involving females that are not ready for spawning. The elicitation of sexual activity seems to be related to the intensity of light and with *P. vannamei* and *P. stylirostris* occurs much earlier when the sky is overcast. (Aquacop, 1977b). Mating in captivity begins late in the afternoon and continues until around nightfall. This same sequence seems to be followed in all the litopenaeids.

In open-thelycum penaeids that have no spermatheca, including *P. vannamei*, *P. stylirostris*, *P. setiferus* and *P. occidentalis*, the spermatophore is attached to the exterior of the thelycum of a hard shelled, fully mature female only hours before spawning. The reproduction sequence is: molt-mature-mate-spawn. Spawning, the monocular discharge of recently ovulated oocytes, is preceded by release of sperm from the spermatophore of open-thelycum species. As the oocytes are discharged into the sea, they brush past sperm-coated setae surrounding the gonopores. Primary binding

occurs and sperm undergo the acrosome reaction that facilitates secondary sperm binding and initiates the cortical rod reaction and subsequent nuclear fusion.

Spermatophores are easily dislodged from open-thelycum shrimp, and in some species may break down sequentially prior to spawning. In offshore collections (as well as in the laboratory), three spermatophore conditions are commonly seen in mated *P. setiferus*: (1) the full compound spermatophore; (2) the wings only; and (3) a sperm mass only is present, obscured from vision when legs are in a normal position, but visible when the third pereopods are folded posteriorly.

The attraction of males to females is thought to be through the sexually dimorphic flagella of the males (Young, 1959). The mating behavior in *P. vannamei* has been described by Yano *et al.*, (1988). *P. vannamei* mating was divided into four phases: (1) approach (2) crawling (3) chasing and (4) mating. In *P. japonicus*, *P. monodon* and *P. paulensis*, the male swims parallel and below the female and turns ventral side up and attaches himself to the female (Hudinaga, 1942, Primavera, 1979, De Saint-Brisson, 1985). These processes are the same as observed in *P. vannamei*, and therefore appear to be a common pattern for the mating behavior in penaeid shrimp. Several workers have noted that the male flicks his head and tail and rotates 90° in relation to the female (Figure 30-4), assuming a "hooked" position during mating in *P. monodon* and *P. paulensis*. However, in *P. vannamei* this complex position has never been observed during mating. Only ventral side up attachment (Figure 30-2) has been observed for *P. vannamei*, usually face-to-face, but occasionally an inverted position is observed (Figure 30-5). Two different sex attractants may be produced and released by mature females for signalling sexual receptivity, chasing and

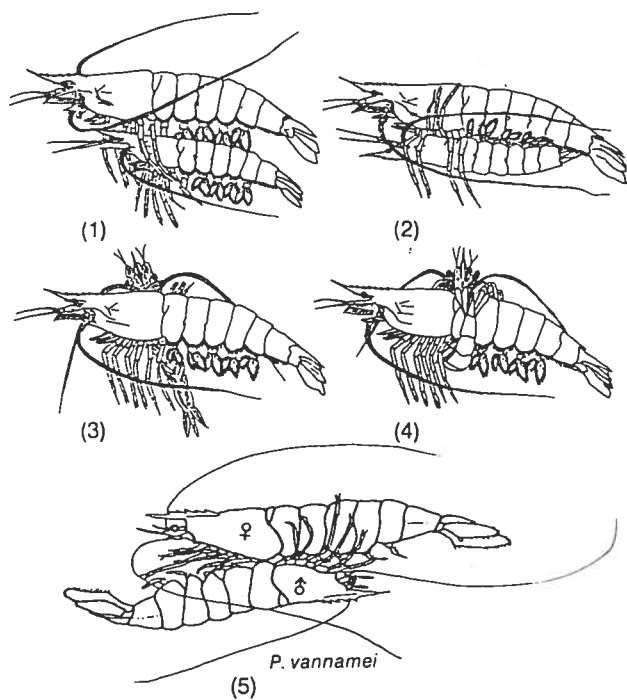

Figure 30.

Courtship and mating behavior of penaeid shrimp. 1) Female above-male below in parallel swimming; 2) Male turns ventral side up and attaches to female; 1) & 2) observed in both *P. monodon* and *P. vannamei*. 3) *P. monodon* male turns perpendicular to female; 4) *P. monodon* male curves body in U-shape around female and flicks head and tail simultaneously (after Primavera, 1979) and 5) In addition to 1) & 2) Yano et al. (1988) observed inverted position in *P. vannamei*.

mating; namely (1) chasing-stimulating pheromone (CSP), and (2) mating-stimulating pheromone (MSP). Many other authors have deduced the presence of sex pheromones in decapod crustaceans (for review, Dunham, 1978).

Mating of Closed-Thelycum Shrimp (Primavera, 1985)

In the closed-thelycum penaeids, mating usually occurs at night between a hardened exoskeleton male and a female just after molting (Figure 30). The spermatophore is inserted into an opening in the exoskeleton corresponding to the same area where it is attached superficially on the open-thelycum shrimp. A position of the spermatophore is visible protruding from the thelycal opening, or seminal receptacle, for about 24 hours until the exoskeleton rehardens and, in a few species, such as *P. japonicus*, a "stopper" remains on the surface throughout the intermolt as evidence of mating. Thus, the sperm is carried internally until the female either spawns or molts. Contrary to the scenario with open-thelycum shrimp, multiple spawns can occur utilizing the same sperm mass within the same intermolt period. At the next molt, the old spermatophore is shed with the exoskeleton and mating proceeds again. Mating seems to follow molting closely in time sequence. Primavera (1979) observed a female *P. monodon* in the laboratory that molted and then began courtship behavior to remate within an hour. It should be

noted that mating in closed-thelycum shrimp is independent of ovarian maturation and begins in rather young shrimp. Eldred (1958) found *P. duorarum* females as small as 91 mm total length mated (about 18 mm carapace length). The molting-mating sequence was first observed by Hudinaga (1942) in *P. japonicus*, and the sequence appears universal among the subgenera other than *Litopenaeus*.

The courtship and mating process is started when the newly molted female attracts from one to three hard-shelled males who follow her as she makes brief upward swimming movements over distances of 50 to 80 cm. Eventually, one male is able to position himself directly below the female. The pair engages in parallel swimming movements, during which the male turns upside down and tries to attach his underside to that of the female. If successful, the male quickly turns around from this direct alignment to a perpendicular position, curves his body in a U-shape around her and flicks his head and tail simultaneously. It is probably during this time that the sperm sacs are inserted inside the thelycum. Among adult *P. monodon*, molting occurs about every three to five weeks; it is synchronous and is spread over a period of five days within a given broodstock tank. Copulation generally takes place at night following molting, which is primarily a nocturnal event.

Molting of the female is a prerequisite to mating since *P. monodon* belongs to the group of penaeids possessing a closed thelycum in which the sperm sacs have to be inserted into receptacles within the thelycum. Insertion can only take place when the thelycum is soft, i.e., the female has just molted. The sperm remain within the thelycum until spawning when the female releases the sperm simultaneously with the eggs. If she does not undergo spawning because her ovaries remain immature, the sperm sacs are expelled with the shell during the next molting, shortly after which fresh sperm sacs are inserted once mating takes place. Mating does not accelerate ovarian maturation directly, according to Yano (1987).

Spawning and Rematuration (Primavera, 1985)

Spawning generally takes place between 8:00 p.m. and 6:00 a.m., although most females spawn between midnight and 4:00 a.m. Normally at rest or slow-moving on the bottom, a female about to spawn becomes restless and starts swimming upwards in circles. The eggs are released, often forcefully, as she swims and may continue even as she rests on the bottom. Spawning lasts from two to seven minutes.

Of a given batch of Stage III or IV females, only 50 to 80 percent will actually spawn. Of all females that spawn, roughly 50 percent are partial spawners while the rest completely spawn all the eggs. Partial spawning or non-spawning may be associated with stress due to transport, handling, crowding, etc. Fully developed females or partial spawners will either spawn or continue spawning in the next two to three days or regress their ovaries. The nature of a spawning can be determined by holding the female to a bright light—some of the anterior or posterior portions of the ovaries remain in partial spawners while complete spawners have no traces of the ovaries.

In nature, *P. monodon* females probably spawn more than once in a spawning season. Tagging experiments show that of a given number of ablated females that spawn once, 14 percent will spawn a second time, 3 percent a third time, and 0.8 percent a fourth time. A subsequent spawning may take place as quickly as three to five days after the preceding one.

The act of spawning itself takes several minutes. A female initially is resting on the bottom of a spawning tank. She begins to swim upward just before spawning, sometimes with rapid flexing of the abdomen. The swimming slows, and eggs are expelled from the oviducts into the water, the pleopods moving rapidly. Spawning is frequently observed at the water surface in spawning tanks, and occurs about midnight or soon afterward.

Fecundity (Primavera, 1985)

Penaeids are extremely fecund, and may produce from 100,000 to 1,000,000 eggs per spawning. The larger species and the larger females within a species generally produce larger numbers of eggs. In captivity, spawns generally range from 50,000 to 300,000 ova.

Evidence indicates multiple spawning of unablated *P. setiferus* (five spawns per lifetime) and at least two spawns per season for *P. setiferus*, *P. duorarum*, *P. japonicus* and *Metapenaeus affinis*.

In captivity, multiple spawning of unablated *P. japonicus* has been shown. In one case, an unablated female spawned 19 times in seven months. Unablated *P. merguensis* have been noted to spawn each 2.6 months in captivity compared with an average 2.8 for *P. japonicus*.

Viable eggs hatch within about 12 to 14 hours of spawning at 28°C. After hatching, the larvae develop through the non-feeding stages (nauplius 1 through 5 or 6) in about 30 hours. With transition to Zoea 1, the larvae require specialized diets.

According to Primavera, for average-size *P. monodon*, fecundity or number of eggs produced by one female in a complete spawning ranges from 100,000 to 400,000 with an average of 200,000 for ablated females, and 200,000 to 1 million with an average of 500,000 for wild females. The eggs and nauplii counts from spawns at the Dian Desa Hatchery were above-average (584,000 to 600,000 per-spawn-average of 22 spawns) and were probably due to above-average females (193g to 450 grams).

A spawner may produce good or bad eggs. To avoid wasting time and effort in rearing inherently weak larvae, the quality of eggs from a single spawning should be determined as early as possible. Preliminary observations show that *P. monodon* eggs can be classified into various grades. Good eggs undergo normal cleavage and development of the nauplii and various abnormal types (Figure 29). A random sample of eggs (about 200) should be examined and classified between 10:00 a.m. and 11:00 a.m. the day of a spawning. If less than 40 percent of the eggs from a given batch are classified as normal, the batch should be discarded. Given ideal water quality, temperature, etc., hatching rate is directly proportional to the number of good eggs produced. See Magarelli (1981) for further information, primarily with reference to *P. stylirostris*.

Hormonal Control (Chamberlain *et al.*, 1985)

Sources of hormones involved in reproduction are the medulla terminalis X organ of the optic ganglia, sinus gland, brain and thoracic ganglion, androgenic gland, ovary and Y organ. The X organ and sinus gland are juxtaposed within the eyestalks of penaeids (Van Herp *et al.*, 1977). The sinus gland is a neurohemal organ comprised of axon terminal that arises primarily from the neurosecretory X organ of the central nervous system (Andrew and Saleuddin, 1979). Biochemical and structural examination of the X organ/sinus gland complex indicates that precursor polypeptides are synthesized in the cell bodies of the medulla terminalis X organ, packaged in neurosecretory vesicles, and transported intraxonally to the sinus gland where they are stored and released as smaller peptide cleavage products (Fingerman, 1970; Andrew and Saleuddin, 1979; Bellon-Humbert *et al.*, 1981). The medulla externa X organ may regulate the rate of gonad-inhibiting-hormone (GIH) production (Faure *et al.*, 1981). The X organ/sinus gland complex has been implicated in hormonal control of numerous processes including sugar, respiratory and calcium metabolism, reproduction, molting, osmoregulation, seasonal thermal acclimation, retinal pigment migration and color changes (Kamemoto *et al.*, 1966; Adiyodi and Adiyodi, 1970; Silverthorn, 1975; Kleinholz, 1978; Kulakovskii and Baturin, 1979).

Panouse (1943) was the first to recognize that removal of the X organ/sinus gland complex by eyestalk ablation often results in premature or nonseasonal gonadal hypertrophy. This effect has been attributed to removal of gonad inhibiting hormone (GIH), which is neither sex- nor species-specific (Otsu, 1963; Bomirski *et al.*, 1981). The amount of GIH produced within the eyestalk varies with season and maturation stage. Experiments from female *Crangon crangon* show that GIH activity is high after the breeding season.

GIH is presumed to inhibit release of gonad-stimulating hormone (GSH) from the brain and thoracic ganglion. GSH, in turn, is thought to stimulate secondary vitellogenesis in females, and precocious spermatogenesis, hypertrophy of the vas deferens and hypersecretion of the androgenic gland in males. The action of GSH may be mediated through steroid hormones.

The role of the Y organ (analogous to insect prothoracic and ring glands) in reproduction is not well understood. This endocrine gland produces ecdysone from cholesterol at rates regulated by molt inhibiting hormone (MIH), which is released from the X organ/sinus gland complex. Circulating ecdysone is converted to the more active molting hormone, B-ecdysone, through the hydroxylase activity of peripheral tissues such as the testes and hepatopancreas (Bollenbacher *et al.*, 1978; Chang and O'Conner, 1978). B-ecdysone primarily stimulates molting, but may also stimulate mitosis of gonial cells and influence vitellogenesis (Adiyodi and Subramoniam, 1983). The release of the eyestalk hormones, MIH and GIH, are reciprocally coordinated to avoid simultaneous involvement of the organism in the energy-demanding processes of molting and reproduction. Emmerson (1980) found that 44.4 percent of the spawns of *P. indicus* occurred during the intermolt phase, 52.1 percent during early premolt and 3.5

percent at premolt, but none occurred during late premolt or early postmolt. During premolt, mature ovaries were reabsorbed, presumably to provide nutrients for molting. This alternating hormonal dominance explains why eyestalk ablation sometimes accelerates reproduction and other times accelerates molting and somatic growth, depending upon the process that would have normally transpired next (Bliss, 1966; Highnam, 1978). Research in this area continues with a number of groups publishing their results (Quackenbush and Herrnkind, 1983; Quackenbush and Keeley, 1986; Rankin *et al.*, 1989; Rankin *et al.*, in press and Bradfield *et al.*, 1989).

Eyestalk Ablation Background and Research

The stimulating effect of eyestalk ablation on reproduction of decapod crustacea (Panouse, 1943) was not used for shrimp aquaculture until the early 1970s when bilateral eyestalk ablation was first attempted. This was found to stimulate rapid ovarian maturation, but ablated females suffered high mortality (probably due to MIH and GIH desynchronization), and their eggs were usually reabsorbed rather than spawned (Caillouet, 1972; Aquacop, 1975; Duronslet *et al.*, 1975). These problems were alleviated with the use of unilateral eyestalk ablation, which provides moderate stimulus without reabsorption of ova or excessive mortality (Aquacop, 1975; Arnstein and Beard, 1975; Wear and Santiago, 1976). Consequently, unilateral eyestalk ablation rapidly emerged worldwide as a simple procedure for inducing reproduction of numerous species of captive penaeid shrimp and some researchers used ablation to increase the growth rate of shrimp (Hameed and Dwivedi, 1977).

Eyestalk ablation has been performed using a variety of methods including severing with scissors (Caillouet, 1972), cautery (Duronslet *et al.*, 1975), enucleation (Primavera, 1978), and ligation (Schade and Shivers, 1980). Each of these methods has been effective in removing or destroying the X organ/sinus gland complex, but enucleation (squeezing out the contents of the eyestalk through the distal end of the eyeball) has the advantages of simplicity and rapid clotting of hemolymph within the empty eyestalk. Stress can be reduced and losses minimized if shrimp are held in chilled water before and after ablation (Caillouet, 1972).

The effects of eyestalk ablation vary with the season of the year and the stage in the molt cycle. Shrimp that are ablated as they prepare to enter their reproductive peak are more conditioned to yield a reproductive (as opposed to molting) response than those entering a reproductively dormant period (Bliss, 1966; Adiyodi and Adiyodi, 1970). Within a molt cycle, ablation performed during premolt leads to molting; ablation immediately after molting causes death; and ablation during intermolt leads to maturation (Aquacop, 1977).

The fecundity and viability of spawns from ablated females have been inferior to spawns from females matured in the wild (Aquacop, 1977; Beard and Wickins, 1980; Emmerson, 1980; Lumare, 1981). Furthermore, commercial producers prefer postlarvae produced from wild rather than captive spawns, which suggests that embryonic characteristics may influence juvenile survival and

growth. Anilkumar and Adiyodi (1980) found that eyestalk ablation of the crab *Paratelson hydromous* during the prebreeding season resulted in precocious ovarian growth. However, in comparison to normal mature ovaries, the ovaries from ablated females were smaller, higher in lipid composition, and more variable in distribution of yolk among oocytes. These differences presumably are consequences of hormonal insensitivity of ablated shrimp to physiological or environmental limitations such as improper oocyte differentiation, nutrient storage, food supply or temperature.

After spawning, unilaterally ablated females immediately reinstate ovarian maturation and consequently spawn more frequently under non-optimal conditions than unablated females. This fast pace can deplete female nutrient stores and is probably partly responsible for the lower survival rates of ablated to unablated females. Emmerson (1980) reported that ablated *P. indicus* that spawned repeatedly every five days lost condition and died, but suggested that this problem could be alleviated by proper nutrition.

Eyestalk ablation of male shrimp has rarely been considered necessary. Alikunhi *et al.*, (1975) reported that male ablation caused precocious maturation of *P. monodon* and *P. merguensis*. Chamberlain and Lawrence (1981) found that male eyestalk ablation increased gonad size and doubled mating frequency of undersized (25-30 g) *P. vannamei* in comparison to unablated control shrimp. Ablation is not considered necessary for adult males.

Maturation Feeds

A combination diet is most often used and gives the best results, usually one consisting of squid and other products such as shrimp and shellfish (clams, oysters, etc.). An effective dietary supplement for maturing shrimp is the bloodworm, which is very expensive. Bloodworms are thought to provide long-chain fatty acids essential in maturation. The bloodworms *Glycrea dibrachiata*, commonly referred to in the United States as the Maine bloodworm because of its geographic source, is also found in other geographic areas. Panama, for example, has bloodworms rich in polyunsaturated fatty acids (PUFA), but it is illegal to export the worm unless it is mixed with the oysters and sold as "maturation food." Middleditch *et al.*, (1980) showed that *P. vannamei* grown in captivity reached sexual maturity when fed diets similar in fatty acid profiles to that of the Maine bloodworm. Bloodworms have a high n-3 to n-6 PUFA ratio and this variable is thought by some to be the key factor necessary for a maturation diet. Lytle and Lytle (1989) looked at the fatty acid composition and variations in individual bloodworms. Dechan and Chen (1975) described the process required for the culture of a similar Lugworm species which could be modified for bloodworm. Results indicate squid, oysters and a diet supplement made from *Artemia* called Marilla appear to best match the fatty acid profile of bloodworms. A large hatchery in Panama reported that Marilla, when added to the maturation diet, saved approximately \$27,000 U.S./year by increasing the frequency of females spawning, the total number of viable eggs spawned and the survival rate of the nauplii produced (WAS Conference, Guayaquil,



Photo 29. Acclimating broodshrimp for temperature and salinity before placing in maturation tank.

1987). Magarelli (1981) also found sex-specific nutritional requirements for crude protein and fat in cultured *P. stylirostris* broodstock. He found that the female shrimp required a higher protein level, a lower fat level, a higher protein/calorie ratio and a much higher protein/fat ratio than males. Again, a combination diet is most often used so that all of the essential requirements are met for both males and females.

Broodstock Operations

Penaeus monodon, obtained principally from local fishermen, is the species being matured and spawned on a regular basis in the Dian Desa Hatchery. *P. monodon* appears to be seasonally available from fishermen at a reasonable price (\$2,000 Rp for a 50- to 80-gram male and \$6,000 to \$10,000 Rp [\$6.00 to \$10.00 US]) for mated female shrimp, depending upon their size, stage of maturation, health, etc. Of the three species obtainable from local fishermen (*P. merguensis*, *P. semisulcatus* and *P. monodon*), *P. monodon* is the only species that can be obtained in sufficient numbers (from fishermen) to support or sustain a maturation program for a hatchery of this size.

The larval-rearing section of Unit 1 is designed to produce three million postlarvae per month. *P. monodon* also appears to be the species of choice because it is hearty, very productive, matures and spawns easily, survives well in larval rearing with minimal feed levels, and grows out well in high densities in the ponds. It is the preferred species of most postlarval buyers. The following is an account of the procedures presently being used at the Yayasan Dian Desa Hatchery to produce larvae successfully for the adjoining larval-rearing facility.

Broodstock Receiving and Shipping

Fishermen usually bring the brood animals to the hatchery during the late afternoon to early evening hours. The animals range in size from 75 grams to 400 grams (with the average weight being 193 grams). At that time the animals are inspected for stress, abrasions, cuts, or other damage that might eventually cause them to die. When a shrimp passes this initial inspection and is received, it is placed into a plastic container with aeration

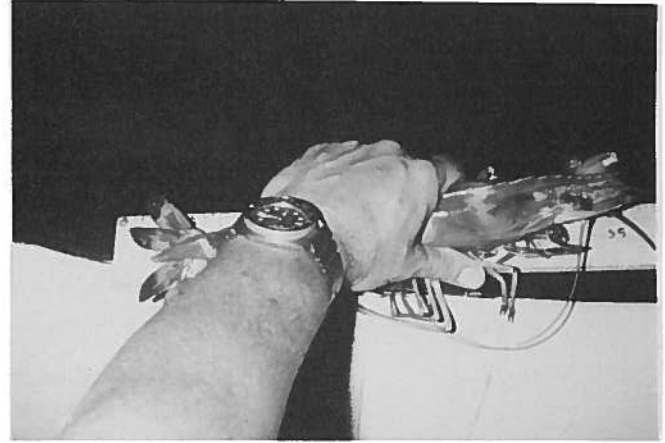

Photo 30. Measuring broodshrimp to get length to weight conversion for tank biomass estimate. This female was 355 mm long and weighed 450 grams (one pound!).

and is acclimated to hatchery conditions (Photo 29) with the following guidelines:

- No more than 2° C per hour temperature change
- No more than 2 ppt salinity change per hour

The animals are usually stressed and care must be taken to see that the stressful conditions are improved or stopped, otherwise mortality will be high.

Distribution into the maturation production tanks is on an as-needed basis or new animals can be held in a separate tank until needed. It is best to wait until all stress is gone before ablating the female.

The first choice of the hatchery is to obtain wild-caught, mated females (in late stages of development) from fishermen and hold the females until they spawn. Being that this is only seasonal, the hatchery must be equipped to sustain production on a year-round basis; therefore, intensive maturation techniques are practiced during the periods in which mated females are not readily available.

Refer to Robertson *et al.*, 1987b W.A.S. 18(2):45-56 for broodstock shipping recommendations.

Broodstock Holding Ponds

Animals being held in broodstock holding tanks should be treated the same way as in broodstock production tanks (same water supply and flow rate, same temperature range, photoperiod, feeding regime, aeration, etc.). Maintenance of broodstock ponds has been described by a number of sources. One method is as follows:

1. Stocked 7,000 to 10,000/ha (2,800 to 4,000/ac.)
2. Prior to filling, the pond is dried (~7 days), and limed if soil pH is less than 5 at 500 kg/ha. It is then fertilized with 16-20-0 inorganic fertilizer at 100 kg/ha and chicken manure at 350 kg to 500 kg/ha and filled slowly. Benthic growth is encouraged during slow fill (7 to 10 days). Water exchange varies from 3 to 6 percent (minimum) to 25 percent, depending on dissolved oxygen.
3. Food consists of pellets containing a high-percent protein given two or three days per week at 3 percent body weight per day. The animals also are given fresh food (fish, scraps from maturation tanks, etc.) at 5

Figure 31. *Penaeus vannamei* and *monodon*
Length to Weight Conversion

Total length (mm)	Weight of Whole Shrimp (grams)
135	19.10
140	21.25
145	23.56
150	26.02
155	28.65
160	31.46
165	34.43
170	37.59
175	40.93
180	44.46
185	48.19
190	52.12
195	56.25
200	60.59
205	65.15
210	69.93
215	74.94
220	80.17
225	85.65
230	91.36
235	98.74
240	105.91
245	113.60
250	121.85
255	130.70
260	140.19
265	150.38
270	161.30
275	173.01
280	185.58
285	199.05
290	213.51
295	229.01
300	245.65
305	263.49
310	282.62
315	303.15
320	323.15
325	343
330	363
335	383
340	400
345	420
350	440
355	450



Photo 31. Squid, purchased from local fishermen, are kept frozen until fed as maturation food (squid makes up 50 to 75 percent of the diet).

percent body weight per day for four or five days per week (care must be taken not to overfeed fresh foods).

Broodstock Distribution and Feeding

Upon receiving brood animals a length measurement is taken (Photo 30) and later converted into weight using the chart shown in Figure 31.

The length/weight is recorded on the data sheet (Figure 32). This method is much quicker and less stressful on both the animal and the operator (obtaining an accurate weight without stressing the animal is nearly impossible).

The total biomass is then determined for the tank and a feeding regime is established. A 1:1 sex ratio is desirable in the maturation tank (equal number of males and females), stocked at a density of no more than five animals per square meter or, in the case of very large animals (173 grams to 400 grams), no more than 7,000 grams total biomass or total body weight in one tank (20 males, 20 females with an average weight of 173 grams). Otherwise, too much food will have to be placed in the tank at one time to keep the animals fed and it would be almost impossible to maintain oceanic conditions. Generally, brood animals gain 5 grams total body weight per month for 55 to 80 grams total body weight. Feed rate is best determined in a production mode by trial and error or *ad libitum* feeding (feeding just enough so that there is a small amount remaining before the next feeding) or feed to satiation (all they want to eat plus a little). Brood animals like fresh or freshly frozen food and they also like a variety. A variety or combination diet is also best for them. They will eat more if fed smaller quantities more frequently (they will consume more food if fed the same amount, for example, 100 grams x 4 times a day, than they will if fed them 400 grams once a day). Subsequently, the more food they consume, the healthier they are, the more active they are



Photo 32. Small shrimp are also purchased locally and kept frozen until needed to supplement the maturation diet (they are thawed and fed whole).



Photo 34. All of the maturation food is spread evenly around the tank at four different feeding intervals during a 24-hour period.



Photo 36. Broodshrimp settling in and eating squid; some are more stressed than others upon arrival and appear red in color and swim at the surface until they too settle in.

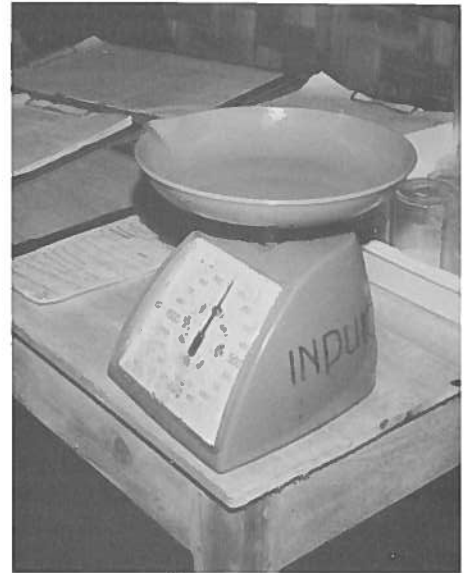

Photo 33. Maturation food is weighed so overfeeding does not begin to degrade oceanic quality water (an inexpensive plastic scale is used).



Photo 35. Excess food and debris is siphoned from maturation tanks twice a day to maintain oceanic quality water.



Photo 37. Healthy broodshrimp about one week after stocking; ready for ablation and to be placed in production.

Figure 32. Length and Weight Data Sheet

Tank or Pond # _____ Date: _____ Batch # _____ Person: _____

Number Shrimp Measured: _____ Average Length: _____

Standard Deviation: _____

Average Weight: _____ Mean Average Weight: _____

Section below refers to length in mm of shrimp sampled/wt.(g)

01.	26.	51.	76.
02.	27.	52.	77.
03.	28.	53.	78.
04.	29.	54.	79.
05.	30.	55.	80.
06.	31.	56.	81.
07.	32.	57.	82.
08.	33.	58.	83.
09.	34.	59.	84.
10.	35.	60.	85.
11.	36.	61.	86.
12.	37.	62.	87.
13.	38.	63.	88.
14.	39.	64.	89.
15.	40.	65.	90.
16.	41.	66.	91.
17.	42.	67.	92.
18.	43.	68.	93.
19.	44.	69.	94.
20.	45.	70.	95.
21.	46.	71.	96.
22.	47.	72.	97.
23.	48.	73.	98.
24.	49.	74.	99.
25.	50.	75.	100.
			101.
			102.

sexually, and the more eggs they produce. Refer to Figure 33 for an objective step-by-step method of determining broodstock feeding rates. Seventeen percent of the total body weight per day is a good initial percentage; make adjustments from there. Maturation animals are fed a high protein diet consisting of squid (cumi-cumi) (Photo 31), small shrimp (Photo 32), and small fish and clams when available. Feeding amounts are divided equally and fed at 0730, 1200, 1600 and 2100 hours. Food must be thawed completely (if frozen) in seawater, cut into small pieces, weighed and distributed evenly around the tank so all shrimp can eat generous portions with little movement required on their part (Photo 34). Excess food is removed from the tank at 0700 and 1530 hours by siphoning (Photo 35).

Ablation of Female Broodstock at Dian Desa Hatchery

Ablation or unilateral eye content removal stimulates ovarian or egg production. After removing the contents of one eye, egg development can be seen as soon as three days, and the first spawn should be observed within six to seven days of ablation. Ablation should take place only after the animals have recovered from the stress of transfer and appear to be healthy (no red appendages or red gills, show active feeding habits, swimming, etc., Photo 36). Ablation should be conducted during the morning hours when the water temperature is slightly cooler. It is not necessary to chill the water, but ablation in 29 to 30° C water will surely cause some stress and mortality. The

Figure 33. Feed Rate Determination

1. Take weight (length and convert) samples of at least ten (10) animals chosen randomly.
2. Find the mean (average) weight of those animals.
3. Multiply the mean weight by the number of animals in the tank. This gives the **Total Body Weight (TBW)**.
4. Determine what percentage of that TBW is to be fed to the animals. [Example: 3.2 percent; 4.50 percent; 5 percent; etc. (start at 3.75 percent/day)]
5. Multiply the TBW by the chosen percentage. This gives the **Dry Weight Basis (DWB)**.
6. Determine what percentage of the different types of food will be fed during a particular period (Example: 20 percent of DWB will be whole shrimp or 30 percent of DWB will be marine worms). Figure what percentage of the DWB a given food represents.
7. In the case of all foods containing water (worms, squid, shrimp, etc.), multiply the figure found in Step 6 by the **Wet Weight Factor (WWF)**. In all the foods we plan to use at this time, the WWF equals 5. In the case of dry combination feeds, do not multiply.
8. Determine how many feedings the above will be divided into and divide accordingly (Example: 50 percent of the MW in the morning and 50 percent in the evening).
9. Determine the above (8) for all feeds for the morning, noon and evening feedings.

Example:

- The mean weight of ten (10) animals is 50 grams.
- The number of animals in the tank is 30.
- Therefore, 50g x 30 animals = 1500 TBW.
- The percentage of the TBW to be fed is 3.25 percent.
- Therefore, 1500g x 3.25 percent = 48.75g DWB.
- 30 percent of the DWB will be marine worms.
- Therefore, 30 percent of 48.75g = 14.63g.
- The wet weight factor of MW is 5.
- Therefore, 14.63g x 5WWF = 73.15g or 73g of MW will be fed to that tank/day.
- 50 percent of the MW will be fed in the morning and 50 percent will be fed in the evening.
- Therefore, 50 percent of 73g = 36.5g MW morning feeding and 36.5g MW for the evening feeding.

The easiest way to feed is to start with 10 percent body weight per day. If there is food remaining before the next feeding, then cut back slightly or if there is no food, then increase the amount slightly. The idea is to feed them all they want, leaving *just a little* to remove daily. Feed four times a day, with the largest quantity being fed at night (25 percent at 0900 hours after siphoning out excess from the night before, then 10 percent at noon and 10 percent in the afternoon at 1600 hours, with optimum feeding time at night after mated females are pulled out, feed 55 percent of the daily ration). Amounts eaten will vary daily.

Note: They will consume more food if fed in smaller quantities, more times per day. Be very careful not to over-feed. Oceanic conditions are *most important*, if maturation is desired.

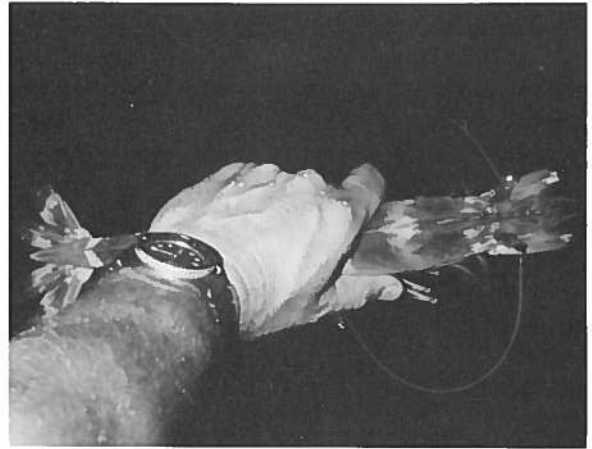

Photo 38. Author demonstrating proper inspection and handling techniques for broodstock.

contents of one eye are removed by holding the female gently but firmly underwater with one hand and pinching the eye stalk and rolling the eye contents outward (away from the body) between the index finger and thumb of the other hand. The contents of the eye are expelled into the water column and the female is gently released. Signs of shock are not abnormal. The hemolymph should clot immediately and form a light blue sphere where the contents of the eye were previously located. Do not re-ablate females. Do not ablate on both sides (this will eventually kill the animal). The unilateral ablation process facilitates sex recognition for the remainder of time the broodstock are being held in a production mode.

Shrimp should be ablated only when hard-shelled (Photo 37), never when in post-molt (newly molted or soft-shelled) or premolt (ready-to-molt, with white spots on shell) stages. The procedure is as follows:

1. Hold the shrimp gently but firmly with one hand, preferably in the water (Photo 38). Only females are ablated.
2. Ablation is performed on either the left or right eye. However, an already infected or otherwise damaged eye should be ablated to leave one unablated, healthy eye.
3. Ablation may be performed in any of the following ways:
 - a. Pinching — Grasp the eyestalk, just behind the eyeball, between the thumb and index finger. Squeeze hard and roll the thumb and finger outward, thus crushing the eyestalk and squeezing out the contents of both it and the eye. The objective is to squeeze the contents outwards and not let it follow the eyestalk back into the head region. An incision on the front of the eye with a sharp blade may be made to aid this process. Some people prefer this method, but it is merely a matter of preference. We have found the incision to be unnecessary, and prefer to hold the shrimp underwater and complete the process as fast as possible to minimize stress.
 - b. Ligation — A piece of string is tied around the base of the eyestalk, close to the carapace. The eye should fall off in a few days (Primavera, 1985).
 - c. Cautery — The eyestalk is ablated either by electrocautery or with a silver nitrate bar.

4. To minimize stress and damage to the animal, the ablation should be performed as quickly as possible and can be done under chilled water. Ablation in commercial hatcheries is usually done in the early morning when temperatures are lowest. Female mortality due to ablation should be very low, but some mortality should be expected. A soft nylon net is used (Photo 39).

Pinching is the preferred method of ablation. It can be done by one person and the wound will heal rapidly without requiring antibiotics. Ligation requires two persons, one to hold the shrimp and the other to tie the eyestalk. Cautery requires either a cauterizer or silver nitrate bar, neither being easily available. Egg development in some females should become visible three days after ablation and the first spawn should occur approximately one week after ablation. The tank should be in full production three weeks after ablation. If ablated during the inter-molt stage, the females will mature and spawn immediately. However, if ablated during early premolt they will molt first, before maturing.

Some researchers have been able to obtain egg development, mating and spawning without ablation, utilizing temperature and photoperiod manipulation, but no one has yet been able to base a long-lasting, profitable, highly productive commercial operation on this approach. Researchers (Chan *et al.*, 1988; Bradfield *et al.*, 1989; Rankin *et al.*, 1989; Chan *et al.*, in press; Rankin and Davis, 1990; and Rankin *et al.*, 1990) are now attempting to characterize and isolate the hormones involved in maturation in hope of eliminating some of the side effects (fewer fertile eggs and larvae per spawn with ablation and brood animals "burning out" after three months). Until ablation can be eliminated successfully and replaced with a superior method, hatcheries must depend on it to sustain production (Treece and Yates, 1990).

Tank Volume Determination

In order to set a specific flow rate one must first calculate the volume of the tank in which the flow is to be applied. The formula for volume is as follows:

$$\text{Volume} = \frac{3.142 (d)^2}{4} \times h$$

where d = diameter (inside) of tank in centimeters and h = water depth in centimeters. The result should read in cubic centimeters (cc). (1 cc is about equal to 1 ml, 1000 ml = 1 liter).

Example: Maturation tank

$$\text{Volume} = \frac{3.142 (d)^2}{4} \times h \quad V = \frac{3.142 (396)^2}{4} \times 74 \text{ cm}$$

$$d = 396 \text{ cm} \quad V = 123,100 \times 74 \text{ cm}$$

$$h = 74 \text{ cm} \quad V = 9,109,441 \text{ cu. cm}$$

$$V = 9,109 \text{ liters}$$

Maturation Unit

A maturation unit is considered to be one maturation tank that consists of the following:

1. Circular, ferro-cement tank (4 meters in diameter or 13 feet), black interior, with water inflow, aeration and stocked with approximately five shrimp per square meter.

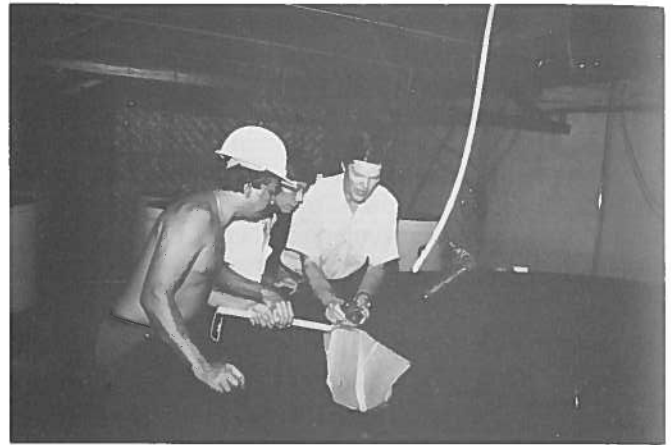

Photo 39. A soft nylon net is used to capture brood for ablation or just for inspection.

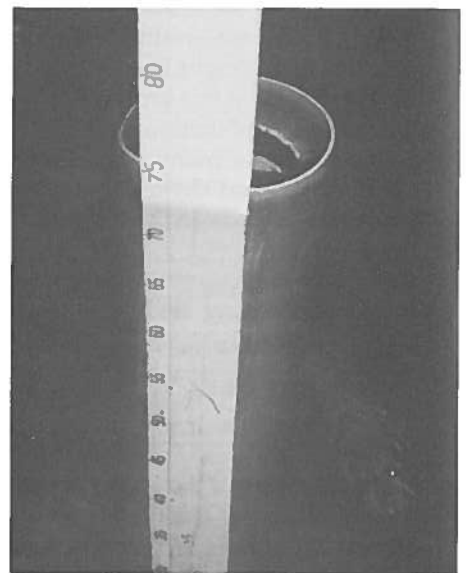

Photo 40. Constant water level maintained in maturation tank by this dual standpipe (water being drawn from the bottom of the tank at this point, but by removing the outer standpipe water can be "skimmed" from the upper surface in case there is excess food floating).



Photo 41. Effluent flow rate is checked daily at the maturation tank to maintain a constant, stable environment.

2. Water level maintained at 74 cm or 29 inches depth gives a volume of approximately 9,000 liters. If visibility becomes poor, then oceanic quality water is not being maintained and steps must be taken to keep water quality high (Photo 40).
3. 200 to 250 percent water exchange per day is optimum (Photo 41). If exchanging this volume of water becomes a problem, lower the water level to 40 cm (16 inches) and continue to turn over water in the tank at 200 percent per day. This would be more desirable than maintaining the same water level and decreasing the flow rate, which would invite protozoan contaminations and cause rapid deterioration of oceanic conditions. *P. monodon* will mate in shallow water but temperature stability is better maintained with a greater volume of water. If flow is interrupted for some reason, then increase the flow rate so that the same overall turnover is achieved.

An example might be a case where a fisherman's boat hits the intake pipe below the water level and puts a hole in the pipe. This means pumps must be shut off at low tide for ten hours each day until the pipe is repaired. The flow rate is increased from 16 liters/minute to 24 liters/minute for 14 hours a day, and temperature is monitored after the flow rate change.

4. Light over the maturation tank is dim and no direct sunlight is allowed to enter. The shrimp and food should be spread out evenly on the bottom if light, water flow and aeration are all adjusted properly. If not, shrimp will be clustered together in the darker areas of the tank, such as around the sides, etc.
5. Constancy is of primary importance in the maturation unit. Temperature optimum is $28^{\circ}\text{C} \pm 1^{\circ}\text{C}$ over a 24-hour period. If temperature fluctuates more than this, such as 26°C to 31°C during a 24-hour period, production may be affected. Salinity should also be stable for best results. The range for optimum maturation of *P. monodon* is 28 to 33 ppt but results are still obtainable with an even wider range (24 to 36 ppt) as long as the change is gradual and not sudden.

Maturation/Hatching Schedule of Activities

This daily procedure list is important to maintain a maturation production room for open-thelycum or closed-thelycum shrimp. It is absolutely required if sustainable maturation results are to be achieved (Figure 34).

Daily Procedure

This procedure should be followed everyday in the maturation facility. Any failure to perform these duties could result in an interruption in the maturation process.

1. **0600 hours.** Lights on. Check maturation tanks for aeration, flows, etc. Check spawning tanks for flows, aeration, etc. Return females in spawning tanks to proper maturation tanks and mark the female by clipping the tip of one of the uropods (tail). Check all maturation tanks for molts (Photo 42) and record. Leave the molts in the tank until late that afternoon for the shrimp to consume. Check maturation tank for mortalities and remove them. Measure or weigh the dead shrimp and place them in the freezer to be used later as feed. Subtract the mortality from the total

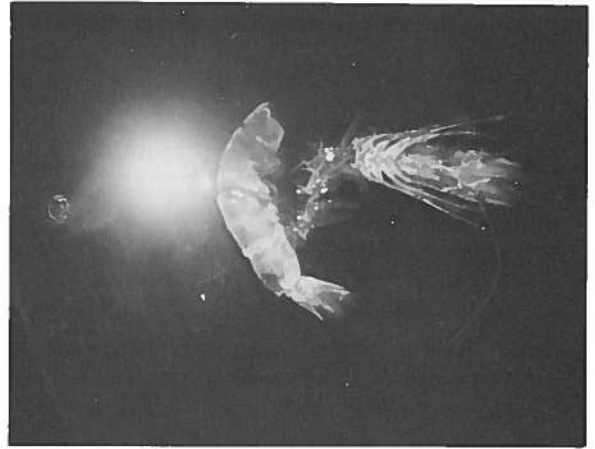

Photo 42. Fresh molt on the bottom of maturation tank.



Photo 43. Salinity readings are taken routinely once a week unless during the rainy season (then refractometer readings may be required more often).

count and body weight in tank and make adjustments in feeding. Record all data on maturation tank log sheet, (Figure 35).

2. **0700 hours.** Check excess feed in tanks and record excess food or no excess; vaccum or siphon the bottom of the tank completely; siphon the first part through a screen to check for eggs from missed spawns or nauplii if a spawn was missed the night before. Record a missed spawn and assign a batch number to it, so the total spawns coming from ablated females and the percentage of females spawning each evening can be monitored. When this number begins to taper off or egg-nauplii quality begins to deteriorate, it is time to initiate the production in a new maturation tank, with fresh animals from the wild. It will become very apparent when production is tapering off if these records are kept.
3. **0730 hours.** Feed animals in maturation tanks. Start with 17 percent of total body weight per day. Feed four times a day. If there is too much excess food after three hours or before the next feeding period, reduce the quantity until there is a small amount of food remaining, but not enough to cause water quality problems.
4. Take water temperatures and record twice daily (once in the morning and once in the afternoon).

Figure 34. Weekly Schedule of Maturation Activities

DO: (Initial when done — Day / Month)

1. 0600 hours. Lights on.
Check all tanks (air, flow, etc.).
2. Return females to proper tanks.
3. Check to see if spawn is fertile in S.T.
(Count eggs later.)
4. Remove any mortalities and note on log sheet.
5. With a siphon, check maturation tanks for eggs.
6. Remove excess food.
7. Feed, check temperatures, check flow rates
(0730).
8. Count number of eggs S.T. and record on Egg-Nauplii Data Sheet.
9. Assign batch # to each new fertile spawn.
10. Count nauplii in S.T.'s, record. Fill out State of Health and transfer
or discard.
11. (1200) Feed, check temperatures.
12. (1530) Vacuum tanks. (Fast vacuum. once each day just before
feeding).
13. (1600) Feed, temps.
14. Set up S.T.'s for evening shift.
15. General clean up (empty garbage, etc.).
16. On Wednesday, clean tank sides, plumbing, etc.
17. (1800) Place late stage developed females in S.T.'s. (Closed thelycum
or brown shrimp: *P. monodon*) If working with white shrimp (open-
thelycum) then pull mated out 1900-2100.
18. (1830) Lights out over maturation tanks.
19. (2100) Check S.T.'s to see if any females have spawned early and
return them.
20. (2100) Feed maturation units.
21. (2330) Check females in S.T.'s. If they have spawned eggs, return to
proper tanks.
22. Lights off for the night.

WEEK OF						
M	T	W	T	F	S	S

5. Take salinity once a week (unless during the rainy season, when it should be taken more often) (Photo 43).
6. If there is a spawn in a spawning tank, stir the tank to suspend the eggs (just turning aeration up is not enough to get the eggs off the bottom). A 2-inch PVC pipe works well to stir, taking care not to hit the bottom with the paddle or pipe. Obtain an egg count by counting the eggs from three 100 ml beaker samples and averaging. The beaker sample is partially poured into a petri dish so it is not necessary to count too many eggs at one time. Counted eggs are returned to the spawning tank and allowed to hatch. The nauplii are counted the same way either that afternoon if stocking in larval rearing is required, or the next morning before transferring N5-N6 to the rearing tanks. Example of an egg or nauplii count: 109/100 ml, 90/100 ml, 120/100 ml. Average count is 106 eggs or nauplii/

100 ml x 8,000 (because there are 8,000 100 mls in an 800-liter volume) = 848,000 eggs or nauplii in the spawning tank.

Record this number on the Egg-Nauplii Data Sheet (Figures 36 and 37) with the batch number and number of larval-rearing tanks to which they were transferred. Eggs will hatch in 14 hours after the spawn at 28°C.

Record hatching rate and discard any hatches that are below 40 percent. For training, do a nauplii state-of-health record (Figure 38) until the observer becomes familiar with important characteristics of nauplii (healthy, strong swimming nauplii, no debris attached, no deformities, etc.). This objective form can be disregarded as long as these criteria are still used to judge if spawns should be saved or discarded.

7. Remove nauplii from spawning-hatching tanks by siphoning or by draining into specially designed nau-

Figure 36. Actual Egg-Nauplii Data Log

Date	Time	Stage	Presently in S.T. or I.M.	# Source	Egg or Nauplii	Fertile Eggs	Batch	Transferred to LRT
17/7	0700	Eggs	MT6	MT6	—	—	1	—
18/7	0700	Eggs	MT6	MT6	91,800	-	2	Discarded
18/7	1100	N1	ST2	MT6	746,666	-	3	LRT 1 & 4
18/7	1300	N1	ST3	MT6	824,160	-	4	
18/7	1300	N1	ST4	MT6	698,880	-	5	
18/7	1300	N1	ST5	MT6	1,468,000	-	6	
18/7	1300	N1	ST7	MT5	187,680	-	7	
19/7	1300	N1	MT5	MT5	-	-	8	Discarded
19/7	1300	N1	MT6	MT6	-	-	9	Discarded
20/7	0930	Eggs	MT6	MT6	-	-	10	Discarded
20/7	1500	N1	ST3	MT6	872,000	-	11	4,889,186 N1 to date
21/7	1200	Eggs	ST1	MT6	-	-	12	not counted
21/7	1200	Eggs	ST2	MT6	136,000	-	13	screen leak
21/7	1200	Eggs	MT6	MT6	-	-	14	Discarded
21/7	1200	N1	ST8	MT5	464,000	-	15	5,489,186 N1 to date
21/7	1200	Eggs	MT5	MT5	-	-	16	Discarded
21/7	1200	N1	ST7	MT5	408,000	-	17	
21/7	1200	N1	ST4	MT6	408,000	-	18	
21/7	1200	N1	ST6	MT6	712,000	-	19	
22/7	0900	Eggs	ST3	MT5	-	24,000	20	
22/7	1030	E-N1	ST5	MT6	1,120,000	(1.16x106)	21	Big Mamoo Gave to Bondo Hatchery
22/7	1030	Eggs	ST9	MT6	-	65,600	22	
23/7	0730	Eggs	MT6	MT6	-	-	23	Discarded
23/7	0730	Eggs	ST9	MT5	896,000	840,000	24	
23/7	0730	Eggs	ST1	MT6	688,000	944,000	25	
23/7	0730	Eggs	ST7	MT6	88,000	512,000	26	17% hatch discarded
23/7	0730	Eggs	ST5	MT6	760,000	808,000	27	
24/7	1200	Eggs	ST3	MT5	-	176,000	28	
24/7	0730	Eggs	MT6	MT6	-	-	29	Discarded
24/7	0730	Eggs	MT5	MT5	-	-	30	Discarded
24/7	0730	Eggs	MT3	MT3	-	-	31	Discarded
24/7	0730	Eggs	ST8	MT6	792,000	648,000	32	
24/7	0730	Eggs	ST10	MT6	364,000	752,000	33	
25/7	0730	Eggs	ST1	MT6		473,000	34	
25/7	0730	Eggs	ST4	MT6	680,000	896,000	35	6 & 7

NOTE: 13,042,786 nauplii counted in eight days of production!

Figure 37.
Maturation/Hatchery
Egg-Nauplii Data Log

Date	Time	Stage	Source St. or Mat.	#Source	# Total Egg Nauplii	# Fertile Eggs	Batch#	Transferred to LRT#

Comments

plic catchers. Discard those nauplii that are not needed in larval rearing or cannot be sold. The best stage to move nauplii is at N5. Feed must be ready and available to the larvae by the zoea stage or high mortality will occur.

- 8. Once a week, brush the sides and bottom of the maturation tank to keep wall growth (barnacles, etc.) to a minimum.
- 9. Before two or more of the maturation feeding periods each day, siphon all excess food, debris and molts (Photo 44) from the tank. Do not feed if there is no



Photo 44. Molts are removed after they are no longer a good food source (usually within 24 hours and they have turned yellow-gold).

flow. Use good judgment in feeding and siphoning to maintain good water quality. The second feeding is at 1200 hours, the third feeding at 1600 hours (if it does not interrupt mating period) and the fourth at 2100 hours.

- 10. Clean spawning tanks daily whether there was a spawn or not. Once a week, the spawning tanks should be cleaned with chlorine and allowed to air dry.
- 11. Remove late-stage females from maturation tanks (Photos 45 and 46) (at 1800 hours for closed-thelycum



Photo 45. Using inexpensive underwater light (attached to PVC pole) to locate late stage female shrimp.

Figure 38.
Larval-State of Health

Batch # _____

Date _____

Time _____

Name _____

		Activity	General Appearance	Absence of Deformities	Absence of Mucus	External debris-bacteria	Setae Developed	Absence of Bent Setae	Photo-Positive Reaction	# Dead	Comments
Microscopic Observations	Larval Sample										
	#1										
	#2										
	#3										
	#4										
	#5										
	#6										
	#7										
	#8										
	#9										
#10											
Total Average											Score

Score Ratings: #3. Excellent, Highest, Most.
#2. Fair, Mid-Range, Average.
#1. Poor, Lowest, Least.

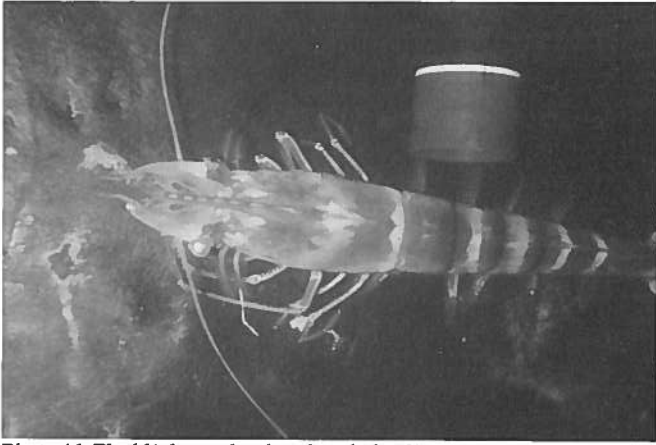

Photo 46. Flashlight can be placed such that light beams show through exoskeleton and stage of developing female is determined.

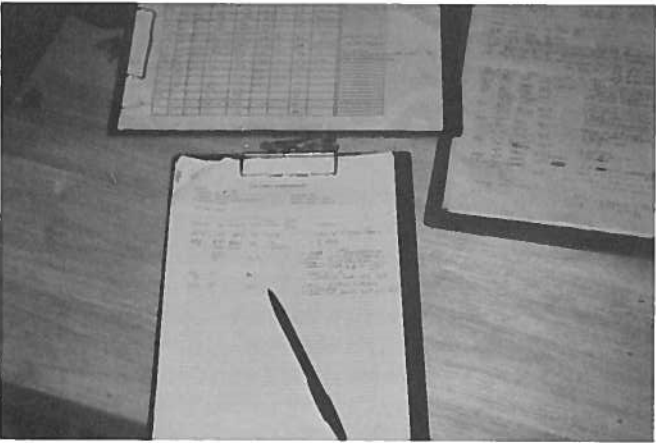

Photo 50. Counting eggs and nauplii out of a 100 ml beaker subsample taken from the spawning tank (note inflow and effluent screen with air collar).

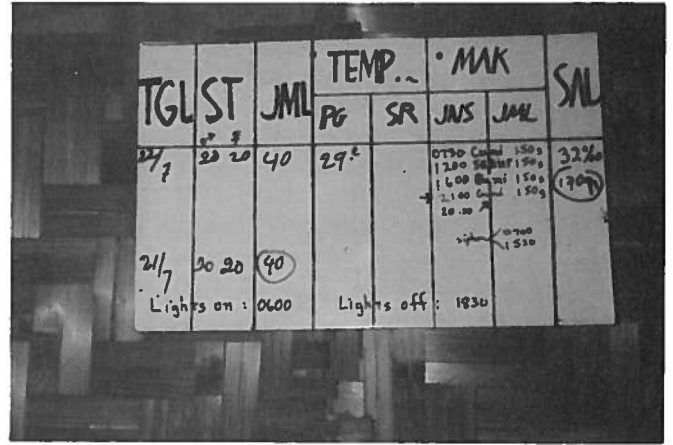

Photo 47. Records are kept for the day on a formica board hung near each tank.



Photo 49. Late stage females are placed individually in a series of 800-liter spawning tanks, each equipped with water inflow and screen standpipe.

shrimp such as *P. monodon*; between 1900 and 2100 hours if working with open-thelycum such as *P. vannamei*) and place in clean spawning tanks with gentle aeration and gentle flow-through (no antibiotics or EDTA are necessary unless there is no waterflow for some reason. Spawning tank turnover should be around 100 to 200 percent to ensure that temperatures are the same as in the maturation tank and to flush out placenta or after-birth when the female spawns. Always use fresh seawater for the spawning tank. Do not use excess water or more than one-day-old water.

12. 1830 hours. Lights go out over maturation tanks.
13. 2100 hours. Last feeding. Check to see if any of the late-stage females have spawned in the spawning tanks. If so, return them to the maturation tanks.
14. 2330 hours. Make sure all lights are out for the night in the maturation area. Check late-stage females in spawning tanks again. Return them to maturation tanks if they have spawned.

Record Keeping

In addition to the previously mentioned data sheets, other important records to keep are those that pertain to individual maturation tanks:

- Maturation Tank Board (Photo 47)
- Egg-Nauplii Data Log (Figures 36, 37 and Photo 48)

It also is a good idea to clip a small portion of the uropod from ablated females each time they spawn. Some females, even though ablated, will never spawn. If a female has not spawned after three weeks (does not have a portion of the uropod missing), she should be replaced.

Spawning and Hatching

A spawning unit (Figure 15) is considered to be one spawning tank that consist of the following:

1. Cylindrical, cement tanks with smooth interior surface (black in color) with slightly sloped bottom with central standpipe. The tank measurements are 110 cm (inside diameter) by approximately the same depth. A central standpipe with an effluent screen maintains a water level at 85 cm depth or a tank volume of 802 liters (Photo 49).
2. The spawning tank is equipped with a constant flow-through set at 1 liter/minute or 180 percent exchange per day. This flow keeps temperatures between the maturation and spawning tanks the same and prevents any temperature shock to the stage-3 female when she is transferred. It also maintains oceanic-quality water, which helps spawning and hatching, and flushes out the placenta or after-birth associated with the act of spawning. A gentle aeration helps maintain a high dissolved-oxygen rate and helps keep eggs from layering on the bottom of the spawning tank. Excellent results have been obtained in comparison with the stagnated condition with only aeration and EDTA-antibiotics added. No chemical additions are necessary with a constant flow system, thus saving time and money.

Spawning generally occurs between 2100 hours and 0200 hours, so females in the spawning tank can be checked and returned to a maturation tank either immediately after spawning or the first thing in the morning. Eggs will hatch 12 to 14 hours after they are spawned at 28°C. Egg counts (Photo 50) are made in each spawning tank during the morning (following the steps outlined in the Schedule of Activities section). Visual observation (using a binocular dissecting scope) of the eggs should indicate at least a 40 percent or greater fertile egg rate or, if preferred, a comparison of the number of total eggs spawned (count in morning) to the number of nauplii hatched should also indicate at least a 40 percent hatch rate or spawn is discarded. Whichever method is preferred, one should be implemented to maintain quality control.

Transferring Nauplii

Nauplii may be transferred to a larval-rearing tank either on the first afternoon (N1-N2) if needed, or left in the spawning tank overnight and transferred as N5-N6 the following day, whichever is more convenient for hatchery operations (coordinated between maturation and larval rearing needs). Nauplii may either be siphoned out of the spawning tank or collected in a nauplii harvester as the tank is drained.

Nauplii should be active, photopositive (swim to the light), free of debris or bacteria, and setae or legs should be well developed with no deformities, before moving them

to a larval-rearing tank. There should not be many dead ones and they should be from a spawn in which at least 40 percent of the eggs hatched. If they do not have all these characteristics, discard the batch and obtain a good one.

For training purposes, an objective test is provided (Figure 38) to familiarize trainees with important characteristics of nauplii. In the nauplii test, ten larvae are sampled and rated excellent (3), fair (2) and poor (1) for each important characteristic. All of the scores are added up and averaged to give a 3, 2 or 1 final score. Nauplii batches with 2 or 1 average scores are discarded if nauplii are in abundant supply and the luxury of selecting spawns can be afforded. Inferior nauplii could also be sold rather than discarded.

Disinfection Procedures

No disinfection treatments have been found necessary at the YDD hatchery. A 24-hour flow is maintained to flush out unwanted protozoans, ciliates, *Zoothamnium* and *Epistylis*. Frequent molting also assisted the animals in shedding off the black chitinous bacteria that is common worldwide on shrimp exoskeletons. No bacteria infection was noted after ablation and mortality was very low, so no prophylactic treatment was deemed necessary. If such problems are encountered during a different season of the year, they should be diagnosed using Johnson's *Handbook of Shrimp Diseases* (1989). This can generally be done by close observation of the infected area of the shrimp (gills, etc.) using a dissecting or a compound microscope. The best treatment and preventive is to maintain good oceanic water quality in the maturation and spawning tanks. In the event that problems do occur, a regime of antibiotic and formalin treatments sometimes helps stop high broodstock mortality. Use one to two antibiotic treatments (Furanace at 2.5 ppm) and one to three formalin treatments (50 ppm). An antibiotic or formalin is added to the tank, water exchange is stopped, and aeration is increased. After one hour, water exchange is resumed at the normal rate. These treatments should only be used as a last resort because the formalin treatment may stress the animals and have a negative effect on production.

A preliminary study on disinfection methods of penaeid shrimp hatcheries contaminated with *Baculovirus penaei* was conducted by Akamine and Moores and reported at the 1989 W.A.S. meeting. They reported that sodium hydroxide proved to be the most efficient of the common materials investigated to disinfect shrimp hatcheries. A method of spraying this chemical was reported with good results. Routine examination procedures are discussed at the end of Chapter 6 and various treatment methods are in Chapter 7.

Selected Maturation References

1. Adiyodi, R.G. and T. Subramoniam, 1983. Arthropoda-crustacea. In: K.G. and R.G. Adiyodi (Editors), *Reproductive Biology of Invertebrates*. Vol. I: Oogenesis, Oviposition, and Oosorption. John Wiley & Sons Ltd., Chichester, N.Y., pp. 443-495.
2. Adiyodi, K.G. and R.G. Adiyodi, 1970. *Endocrine*

- control of reproduction in decapod crustacea. *Biol. Rev.*, 45:121-165.
3. Akamine, Y. and J.L. Moores, 1989. A preliminary study on disinfection methods of penaeid shrimp hatcheries contaminated by *Baculovirus penaei*. Abstract. WAS 1989. p.55.
 4. Alikunhi, K.H., A. Poernomo, S. Adisufresno, M. Budiono and S. Busman, 1975. Preliminary observations on induction of maturity and spawning in *Penaeus monodon* (Fabricius) and *Penaeus merguensis* (de Man) by eyestalk extirpation. *Bull. Shrimp Cult. Res. Cent.*, Jepara, 1(1):1-11.
 5. Andrew, R.D. and A.S.M. Saleuddin, 1979. Two-dimensional electrophoresis of neurosecretory polypeptides in crustacean eyestalk. *J. Comp. Physiol. B*, 134(4):303-314.
 6. Anilkumar, G. and K.G. Adiyodi, 1980. Ovarian growth, induced by eyestalk ablation during the prebreeding season is not normal in the crab *Paratelpusa hydromomous* (Herbst). *Int. J. Invertebr. Reprod.*, 2:95-105.
 7. Aquacop, 1984. Observations sur la maturation et la reproduction en captivité des crevettes *Peneides* en milieu tropical. In: *Aquaculture en Milieu Tropical*, IFREMER, Brest, p. 132-152.
 8. Aquacop, 1979. Penaeid reared broodstock: closing the cycle of *P. monodon*, *P. stylirostris* and *P. vannamei*. *Proc. World Maricul. Soc.*, 10:445-452.
 9. Aquacop, 1977a. Reproduction in captivity and growth of *P. monodon* (Fabricius) in Polynesia. *Proc. World Maricul. Soc.*, 8:927-945.
 10. Aquacop, 1977b. Observations on the maturation and reproduction of penaeid shrimp in captivity in a tropical medium. *Aquaculture Workshop*. ICES, May 1977. Brest, France. (Work done in Taravao, Tahiti; CNEXCOP, P.O.B. 7004).
 11. Aquacop, 1975. Maturation and spawning in captivity of penaeid shrimp: *Penaeus merguensis* (de Man), *P. japonicus* (Bate), *P. aztecus* (Ives), *Metapenaeus ensis* (de Haan) and *P. semisulcatus* (de Haan). *Proc. World Maricul. Soc.*, 6:123-132.
 12. Arnstein, D.R. and T.W. Beard, 1975. Induced maturation of prawn *Penaeus orientalis* (Kishinouye) in the laboratory by means of eyestalk removal. *Aquaculture*, 5:411-412.
 13. Beard, T.W. and J.F. Wickins, 1980. Breeding of *Penaeus monodon* (Fabricius) in laboratory recirculation systems. *Aquaculture*, 20:79-89.
 14. Bellon-Humbert, C., F. Van Herp, G.E.C.M. Strolenberg and J.M. Denuce, 1981. Histological and physiological aspects of the medulla externa X organ, a neurosecretory cell group in the eyestalk of *Palaemon serratus* (Crustacea, Decapoda). *Natantia. Biol. Bull.* (Woods Hole), 160:11-30.
 15. Bielsa, L.M., W.H. Murdich and R.F. Labisky, 1983. Species profiles: life histories and environmental requirements of pink shrimp. *U.S. Fish & Wildl. Ser.* 82/11.17.
 16. Bliss, D.E., 1966. Relation between reproduction and growth in decapod crustaceans. *Am. Zool.*, 6:231-233.
 17. Bollenbacher, W.E., S.L. Smith and L.I. Gilbert, 1978. The biosynthesis of a and b ecdysone: *In vivo*, *in vitro*, and cell free approaches. In: P.J. Gallare and Boer, H.H. (Eds.), *Comparative Endocrinology*. Elsevier/North-Holland Biomedical Press, Amsterdam, pp. 491-494.
 18. Bomirski, A., M. Arendarczyk, E. Kawinska and L.H. Kleinholz, 1981. Partial characterization of crustacean gonad-inhibiting hormone. *Int. J. Invert. Reprod.*, 3:213-219.
 19. Bradfield, J.Y., R.L. Berlin, S.M. Rankin and L.L. Keeley, 1989. Cloned cDNA and antibody for an ovarian cortical granule polypeptide of the shrimp *P. vannamei*. *Biol. Bull.* 177:344-349.
 20. Bray, W.A., Jr., A.L. Lawrence 1991. Reproduction of *Penaeus* species in captivity. Pages 93-170 in A. Fast and L.J. Lester (Eds.), *Culture of Marine Shrimp: Principles and Practices*, Elsevier Scientific Publishing Company, Amsterdam, The Netherlands.
 21. Brown, A., J.P., McVey, B.M. Scott, T.D. Williams B.S. Middleditch and A.L. Lawrence, 1980. The maturation and spawning of *P. stylirostris* under controlled laboratory conditions. *WMS* 11:488-499.
 22. Brown, A., Jr. J. McVey, B.S. Middleditch, and A.L. Lawrence, 1979. The maturation of white shrimp (*P. setiferus*) in captivity. *WMS* 10:435-444.
 23. Brown, A. and D. Patlan, 1974. Color changes in the ovaries of penaeid shrimp as a determinant of their maturity. *Marine Fisheries Review*, Vol. 36:7 p. 23-26.
 24. Caillouet, C.W., 1972. Ovarian maturation induced by eyestalk ablation in pink shrimp, *Penaeus duorarum* (Burkenroad). *Proc. World Maricul. Soc.*, 3:205-225.
 25. Chamberlain, G.W., M.G. Haby and R.J. Miget, 1985. *Texas Shrimp Farming Manual*. Texas Agricultural Extension Service publication of invited papers presented at the Texas Shrimp Farming Workshop on 19-20 Nov. 1985, Corpus Christi, Texas.
 26. Chamberlain, G.W. and N.F. Gervais, 1984. Comparison of unilateral eyestalk ablation with environmental control for ovarian maturation of *P. stylirostris*. *WMS*. 15:29-30.
 27. Chamberlain, G.W. and A.L. Lawrence, 1981. Maturation, reproduction, and growth of *Penaeus vannamei* and *P. stylirostris* fed natural diets. *J. World Maricul. Soc.* 12(1):209-224.
 28. Chang, E.S. and J.D. O'Connor, 1978. *In vitro* secretion and hydroxylation of b ecdysone as a function of the crustacean molt cycle. *Gen. Comp. Endocrin.*, 36:151-160.
 29. Chan, S. S.M. Rankin and L.L. Keeley, in press, Effects of 20-hydroxyecdysone injection and eyestalk ablation on the molting cycle of the shrimp, *P. vannamei*. *Comp. Biochem. Physiol.*
 30. Chan, S., S.M. Rankin and L.L. Keeley, 1988. Characterization of the molt stages in *P. vannamei*: setogenesis and hemolymph levels of total protein, ecdysteroids, and glucose. *Biol. Bull.* 175:185-192.
 31. Cordover R.D. and R.W. Brick, 1972. Guide to the identification of commercially important shrimps of Southeast Asian inshore waters. Unpublished report prepared for the Meekong Committee/Giant Prawn

- Culture Training Program, University of Hawaii, Honolulu, Hawaii.
32. Cummings, W.C., 1961. Maturation and spawning of the pink shrimp, *P. duorarum*. *Trans. Amer. Fish. Soc.* 90:462-468.
 33. Dall, W., 1957. A revision of the Australian species of Penaeinae. *Australian Journal of Marine and Freshwater Resources*. Volume 8, Number 2, Pages 136-231.
 34. Dunham, P.J., 1978. Sex pheromone in crustacea. *Biol. Rev.* 53:555-583.
 35. Dechan, C. and C. Chen, 1975. Bait worm culture of *Aristicus* crit. (Simpson). Sea grant Report #16. Florida Sea Grant College, University of Florida, Gainesville, Florida 32611, USA.
 36. DeSaint-Brisson, S.C., 1985. The mating behavior of *P. paulensis*. *Crustaceana* 50:108-110.
 37. Dore, I. and C. Frimodt, 1987. An illustrated guide to shrimp of the world. *O Spray Books*, Huntington, N.Y. 229 pages.
 38. Duronslet, M., A.I. Yudin, R.S. Wheller and W.H. Clark, Jr., 1975. Light and fine structural studies of natural and artificially induced egg growth of penaeid shrimp. *Proc. World Maricul. Soc.*, 6:105-122.
 39. Emmerson, W.D., 1980. Induced maturation of prawn *P. indicus*. *Mar. Ecol. Prog. Ser.*, 2:121-131.
 40. Farfante, P., 1988. Illus. key to penaeid shrimps of commerce in the Americas. NOAA Tech. Report NMFS, 64, 32 pages.
 41. Farfante, P., 1969. Western Atlantic shrimps of the genus *Penaeus*. U.S. Fish & Wildlife Serv. Fish Bull. 67:461-591.
 42. Faure, Y., C. Bellon-Humbert, and H. Charniaux-Cotton, 1981. Folliculogenese et vitellogenese secondaries chez la Crevette *Palaemon serratus* (Pennant): controle par les pedoncules oculaires et l'organe X de la medulla externa (MEX). *C.R. Acad. Sc. Paris*, 293(3):461-466.
 43. Fingerman, M., 1970. Perspectives in crustacean endocrinology. *Scientia*, 105:1-23.
 44. Fox, J.M., 1987 (unpublished manuscript), "Shrimp culture in Indonesia." distributed by C.J.E.D.P. SEMARANG, JAVA. In the Indonesian Language.
 45. Hameed, A.K. and S.N. Dwivedi, 1977. Acceleration of prawn growth by cauterization of eye stalks and using *Actes indicus* as supplementary feed. *J. India Fish. Assoc. Bombay*, 3-4 (1-2):136-38.
 46. Highnam, K.C., 1978. Comparative aspects of endocrine control of reproduction in invertebrates. In: P.J. Gaillard and H.H. Boer (eds.), *Comparative Endocrinology. Proceedings of the 8th Intl. Symp. on Comparative Endocrinology* held in Amsterdam, The Netherlands, June 19-23, 1978. Elsevier/North-Holland Biomedical Press, Amsterdam, pp. 3-12.
 47. Holthius, L.B. (ed.), 1980. Shrimps and prawns of the world - an annotated catalogue of species of interest to fisheries. *FAO Species Cat.* FAO. Rome.
 48. Hudinaga, M., 1942. Reproduction, development and rearing of *P. japonicus*. *Jap. J. Zool.*, 10(2):305-393.
 49. Johnson, M.C. and J.R. Fielding, 1956. Propagation of the white shrimp *P. setiferus* in captivity. *Tulane Stud. Zool.* 4:175-190.
 50. Kamemoto, F. I., K.N. Kato, and L.E. Tucker, 1966. Neurosecretion and salt and water balance in the Annelida and Crustacea. *Am. Zoologist*, 6:213-219.
 51. King, J.E., 1948. A study of the reproductive organs of the common marine shrimp, *Penaeus setiferus* (Linnaeus). *Biol. Bull*, Wood's Hole, 94(3):244-262.
 52. Kleinholz, L.H., 1978. Crustacean neurosecretory hormones and their specificity. In: P.J. Gaillard and H.H. Boer (Eds), *Comparative Endocrinology*. Elsevier/North-Holland Biomedical Press, Amsterdam, pp. 397-400.
 53. Klima, E.F., 1978. An overview of aquaculture research in the Galveston Laboratory. *WMS* 9, 1978. *NMFS Contrib.* #78-156.
 54. Kow, T.A., 1968. Unit stocks of shrimp and prawns in IPFC region and unit fisheries exploiting them. *FAO Fisheries Reports*, Volume 57, Number 2, Pages 207-218.
 55. Kulakovskii, E.E. and Y.A. Baturin, 1979. The sinus gland of the shrimp *Eualus gaimardi* and its state related to environmental salinity variations. *Tsitologiya*, 21:1200-1203.
 56. Laubier-Bonichon, A., 1978. Ecophysiologie de la reproduction chez la crevette *P. japonicus* (Trois) annees d'experience en milieu controle'. *Contrib.* #564.
 57. Laubier-Bonichon, A and L. Laubier, 1976. Reproduction control with the shrimp *P. japonicus* F.A.O. Tech. Conf. Aqua. Kyoto, Japan FIR: AQ/Conf./76/E.38. 6 pages.
 58. Lawrence, A.L., Y. Akamine, B.S. Middleditch, G. Chamberlain and D. Hutchins, 1980. Maturation and reproduction of *P. setiferus* in captivity. *WMS* 11:481-487.
 59. Liao, I.C. and N.H. Chao, 1983. Hatchery and grow-out: Penaeid prawns. In: McVey, J.P. (Ed.) *CRC Handbook of Mariculture*. Vol. I. pp. 161-167.
 60. Lumare, F., 1981. Artificial reproduction of *Penaeus japonicus* (Bate) as a basis for the mass production of eggs and larvae. *J. World Maricul. Soc.*, 12(2):335-344.
 61. Lytle, J.S. and T.F. Lytle, 1989. Fatty acid composition and variations in individual bloodworms. Gulf Coast Research Laboratory, P.O. Box 7000, Ocean Springs, Mississippi 39564, USA.
 62. Magarelli, P.C., 1981. Nutritional and behavioral components of reproduction in the blue shrimp, *P. stylirostris*, reared under controlled environment conditions. Ph.D. dissertation, University of Arizona.
 63. McVey, J.P., 1983. *CRC Handbook of Mariculture*, Vol. I. Crustacean Aquaculture, J.P. McVey, (Eds.), CRC Press Inc., Boca Raton, Florida, 442 pages.
 64. Middleditch, B.S., S.R. Missler, H. B. Hines, J.B. McVey, A. Brown, D.G. Ward, and A.L. Lawrence, 1980. Metabolic profiles of penaeid shrimp: Dietary lipids and ovarian maturation, *Journal of Chromatography* 195: 359-368.
 65. Motoh, H., 1981. Studies on the fisheries biology of the giant tiger prawn, *P. monodon*, in the Philippines. *Tech. Report No. 7*, SEAFDEC, Philippines. 128 pages.
 66. Oceanic Institute, 1990. Newsline. (Newsletter) March 1990. Vol. 3 No. 1, Disease free shrimp population established in Hawaii.

67. Otsu, T., 1963. Bihormonal control of sexual cycle in the freshwater crab, *Potamon dehaani*. *Embryologia*, 8:1-20.
68. Oyama, R., R. Deupree, M. Edralin, and J. Wyban, 1988. Operation and performance of the Oceanic Institute shrimp maturation facility. *O.I. Tech. Report* #88-1.
69. Panouse, J.B., 1943. Influence de l'ablation du pedoncule oculaire sur la croissance de l'ovaire chez la crevette *Leander serratus*. *C.R. Acad. Sci., Paris*, T. 217:553-555.
70. Primavera, J.H., 1985. A review of maturation and reproduction in closed-thelycum penaeids. In: *Proc. of 1st Int. Conf. on the culture of penaeid shrimp* (1984). SEAFDEC Aqu. Dept.
71. Primavera, J.H., T. Young and C. de los Reyes, 1980. Survival, maturation, fecundity and hatching rate of unablated and ablated *P. indicus*. *Contrib. No. 59* SEAFDEC Aquaculture Dept. 14 pp.
72. Primavera, J.H., 1979. Notes on the courtship and mating behavior in *P. monodon* (Fabricius) (Decapoda, Natantia). *Crustaceana*, 37(3):287-292.
73. Primavera, J.H., 1978. Induced maturation and spawning in five-month-old *P. monodon* (Fabricius) by eyestalk ablation. *Aquaculture*, 13:355-359.
74. Quackenbush, L.S. and L.L. Keeley, 1986. Vitellogenesis in the shrimp, *P. vannamei*. *American Zoologist Abstract*.
75. Quackenbush, L.S. and W.F. Herrnkind, 1983. Partial characterization of eyestalk hormones controlling molt and gonadal development in the spiny lobster *Panulirus argus*. *J. Crust. Biol.*, 3:34-44.
76. Racek, A.A., 1970. Indo-west pacific penaeid prawn species of commercial importance. *Indo-Pacific Fisheries Council Proceedings No. C70/Sym 3*, Pages 1-31.
77. Rankin, S.M. and R.W. Davis, 1990. *Tissue and Cell* (Journal). Ultrastructure of oocytes of the shrimp *P. vannamei* with emphasis on cortical granule formation.
78. Rankin, S.M., J.Y. Bradfield and L.L. Keeley, 1990. (NOAA Tech. Report, UNJR). Ovarian development in the South American white shrimp, *P. vannamei*.
79. Rankin, S.M., J.Y. Bradfield, and L.L. Keeley, 1989. Ovarian protein synthesis in the South American white shrimp, *P. vannamei*, during the reproductive cycle, *Inter. Jnl. of Invert. Reproduction and Development*.
80. Robertson, L., B. Bray, L. Trujillo and A.L. Lawrence, 1987a. Practical molt staging of *P. setiferus* and *P. stylirostris*. *WAS* 18(3):180-185.
81. Robertson, L., W.A. Bray and A.L. Lawrence, 1987b. Shipping of penaeid broodstock: water quality limitations and control during 24 hour shipments. *WAS* 18(2):45-56.
82. Santiago, A.C., Jr., 1977. Successful spawning of cultured *Penaeus monodon* (Fabricius) after eyestalk ablation. *Aquaculture*, 11(3):185-196.
83. Schade, M.L. and R.R. Shivers, 1980. Structural modulation of the surface and cytoplasm of oocytes during vitellogenesis in the lobster, *Homarus americanus*. An electron microscope protein-tracer study. *J. Morphol.*, 163:13-26.
84. Simon, C.M., 1982. Large scale, commercial application of penaeid shrimp maturation technology. *Jnl. W.M.S.* 13:301-312.
85. Silverthorn, S.U., 1975. Hormonal involvement in thermal acclimation in the fiddler crab *Uca pugilator* (Bosc) -I. Effect of eyestalk extracts on whole animal respiration. *Comp. Biochem. Physiol.*, 50A:281-283.
86. Tirmizi, N.M. and Q. Bashir, 1973. Shore and offshore penaeid prawns of Northern Arabian Sea. Dept. of Publ., Univ. of Karachi, Karachi, Pakistan.
87. Treece, G.D. and M.E. Yates, 1990. *Laboratory manual for the culture of penaeid shrimp larvae*. (ablation section). Texas A&M Univ., Sea Grant College Program, TAMU-SG-88-202(R). 95 pages.
88. Tseng, W., 1987. *Shrimp Mariculture, a Practical Manual*. Chien Cheng, Pub. Rep. of China.
89. Van Herp, F., C. Bellon-Humbert, J.T.M. Luub, and A. Van Wormhoudt, 1977. A histophysiological study of the eyestalk of *Palaemon serratus* (Pennant) with special reference to the impact of light and darkness. *Arch. Biol. (Bruxelles)*, 88:257-278.
90. Wear, R.G. and A. Santiago, Jr., 1976. Induction of maturity and spawning in *Penaeus monodon* (Fabricius), 1978, by unilateral eyestalk ablation (Decapoda: Natantia). *Crustaceana*, 31(2):218-220.
91. Wyban, J.A., J.N. Sweeney and W.K. Richards, 1988. Design of the Oceanic Institute shrimp maturation facility. *OI Tech. Report* #88-1.
92. Wyban, J.A. C.S. Lee, J.N. Sweeney and W.R. Richards, 1987. Observations and development of a maturation system for *P. vannamei*. *WAS* 18(3):198-200.
93. Yang, W.T., 1975. A manual for large-tank culture of penaeid shrimp to the postlarval stages. *University of Miami Sea Grant Technical Bulletin*, 31: 94
94. Yano, I., 1987. Maturation of kuruma prawn (*P. japonicus*) cultured in earthen ponds. Proc. U.S. - Japan Aqua. Panel Symp. on Reproduction, Maturation and Seed Production of Culture Species, Baton Rouge, LA. Oct. 1983. U.S. Dept. of Comm. NOAA Tech. Report NMFS 47:3-7.
95. Yano, I., R.A., Kanna, R.N. Oyama and J.A. Wyban, 1988. Mating behavior in the penaeid shrimp *P. vannamei*. *Marine Biology* 97, 171-175.
96. Young, J.H., 1959. Morphology of the white shrimp *P. setiferus*. U.S. Fish & Wildlife Serv., Fish Bull. 59:1-68.
97. Yu, H.P. and T.Y. Chan, 1986. *The illustrated penaeoid prawns of Taiwan*. Southern Materials Center, Inc. Taipei, 183 pages.

Chapter 3

Larval Rearing

Introduction and Background

Penaeid shrimp larviculture techniques seem well established but when compared to age-old agricultural techniques, they must be considered an art rather than a science. Many of the present day techniques used in shrimp larviculture are the direct result of studies dating back to the early 1930's. Credit should be given to the Japanese as well as countless other groups such as the "Galveston group" for establishing the techniques for the successful production of postlarval shrimp. These contributions have been important to the development of shrimp mariculture and have enabled the traditional shrimp fisheries to advance from catch fisheries to farm fisheries (now producing at least 26 percent of the shrimp consumed on the world market).

The origins of penaeid larviculture can be traced back to Japan when Dr. Motosaku Fujinaga (then M. Hudinaga), now recognized as the "Father of Shrimp Culture," successfully spawned and attempted to rear *Penaeus japonicus* larvae in the laboratory (Hudinaga, 1935). Successful rearing on a large scale was first achieved in indoor tanks, using cultures of the diatom *Skeletonema costatum* as food for the zoeal stages and *Artemia* nauplii for the mysis and postlarval stages (Hudinaga, 1942).

There have been many successful modifications through the years, but the same basic techniques are still in practice today. One of those successful modifications came as a result of the National Marine Fisheries Service Laboratory in Galveston, Texas, U.S.A. (Ewald, 1965; Cook and Murphy, 1966, 1969 and 1971; Cook, 1969; Mock and Murphy, 1970; Salser and Mock, 1974; Fontaine and Revera, 1980; Heinen, 1976; Mock *et al.*, 1980; Fontaine *et al.*, 1981 and McVey, 1983) all resulting in what is still called "the Galveston Laboratory Technique." The major difference in the early technique and this modified method was that the larval feed (algae) was prepared outside the rearing container and was fed as needed. Refer to Sinderman (1987) for a more detailed literature review.

At the same time these modifications were being described in the United States, others were making similar contributions (Hudinaga and Kittaka, 1967; Maeda, 1968; Liao *et al.*, 1969; Skokita, 1970; Liao and Huang, 1972; Shigueno, 1972, 1975; Imamura and Sugita, 1972; Kureha and Nakenishi, 1972; Tabb *et al.*, 1972; Villaluz *et al.*, 1972; San Feliu *et al.*, 1973; Pinto and Edward, 1974; Fielder *et al.*, 1975; Hirata *et al.*, 1975; Yang, 1975; Gopalakrishnan, 1976; Aquacop, 1977; Liao, 1977; Tang, 1977; Ting *et al.*, 1977; Millamena and Aujero, 1978; Paton, 1978; Sudhakarao, 1978; Yellow Sea Fisheries Research Inst., 1978; Jones *et al.*, 1979; Motoh, 1979; Emmerson, 1980; Emmerson and Andrews 1981; Gabasa, 1981; SEAFDEC,

1981; Simon, 1981; Kanazawa *et al.*, 1982; Kungvankis, 1982; Hameed *et al.*, 1982; Gabasa and Sunaz, 1983; Liao, 1984; and Tacon, 1986). These are only a fraction of the research papers that contributed to our present knowledge of penaeid shrimp larviculture. The modifications and refinements of the original techniques of larviculture have continued through the late 1980's with numerous groups making further contributions in larviculture (e.g., Wilkenfeld *et al.*, 1983; Sorgeloos *et al.*, 1983; Kuban *et al.*, 1985; Al-Haji *et al.*, 1985; Rothlisberg *et al.*, 1985; Primavera, 1985; Aranyakanada, 1985; Taki *et al.*, 1985; Treece and Fox, 1987; Biedenbach *et al.*, 1987 and 1989a, 1989b; Tseng, 1987; Chamberlain, 1988; Le Moullac *et al.*, 1987; Leger *et al.*, 1987; Yates *et al.*, 1987; Liao, 1988; Treece and Yates, 1988; and Chen *et al.*, 1989).

Cold-tolerant species of penaeid shrimp were the topic of a recent Asian-U.S. workshop. The proceedings, "The Culture of Cold-Tolerant Shrimp: Proceedings of an Asian-U.S. Workshop on Shrimp Culture" (K. Main and W. Fulks, editors, April 1990), are available through the Oceanic Institute. Larval-rearing techniques for *P. chinensis*, *P. penicillatus*, and *P. japonicus* are outlined in this book.

There are many methods of culturing penaeid larvae successfully and the beginning hatchery manager should not be intimidated by the numerous modifications and publications in this area. Penaeid larvae are truly easy to culture if one is aware of the important parameters. This chapter describes one method of culturing *P. monodon* larvae that worked well at the Yayasan Dian Desa Hatchery. Please refer to the drawings and description of the YDD facility in Chapter 1.

Daily Larval and Postlarval Rearing Schedule (YDD)

0700-0800 Check aeration in tanks; check drains for leaks in standpipe, etc.; take temperature in tanks and record on data sheets; take samples of three larvae from each tank and stage them (discard them later and record stage on larval-rearing tank log); record comments about health of larvae (full guts, no debris, some debris, healthy, poor); observe color and behavior, appearance, presence of molts, and look at the shrimp under 4x then 10x power compound scope to look for presence of fungi, *Zoothamnium*, *Lagenidium* or other unwanted organisms on the exoskeleton. Take samples from tanks and run algal cell counts on each. Adjust cell count to minimum of 100,000 cells/ml *Chaetoceros*, and, at the zoeal 2 substage, begin maintaining 20,000 cells/ml *Tetraselmis*.

Figure 39

Larval Rearing Tank Data Log

Nauplii Score: _____
 LRT Number: _____
 LRT Volume: _____
 # Nauplii Stocked: _____
 P¹ Pop. Estimate: _____

Batch Number: _____
 # PLs. Harvested: _____
 % Survival N-PL: _____
 % Survival P¹¹-PL: _____

Date	Time	Stage	Health State	Temp	pH	Food Type	Cell Count Before	Cell Count After	Artemia Counts/data			Comments
									#Art./ml	#Desired	#Art. Fed	

Do not allow cell counts to fall below 40,000 cells/ml at least until the second mysis sub-stage. Take *Artemia* counts in larval rearing tanks (LRTs), but do not feed *Artemia* until 1600 hours. Record all data on the LRT data log sheet (Figure 39).

- 1700 End of formal work day (unless additional work is required in harvesting, transferring nauplii, cleaning tanks, refilling etc).
- 2200 Feed PLs in raceways (this can be done by one person and can be done on a rotating basis since it is after the formal work day is over).

The procedure is similar for postlarval rearing. Take samples of shrimp from each tank and look at them under a 10x compound scope. Look for presence of disease, fungi, etc. Look for full or empty guts. Take *Artemia* counts if feeding *Artemia* and record on the postlarval rearing data sheet. Siphon debris from the bottom of the raceway tanks and then feed PLs in raceways according to the schedule in Table 1. Check flow rates and reset if necessary to 100 percent exchange. Record water temperature of tank.

- 0900 Breakfast (for the staff).
- 0930 Check raceway effluent or siphon effluent for dead PLs/escaping PLs.
- 1000 Harvest PLs or move PLs from LRT to PL raceways. Feed PLs in raceways before staff lunch break.
- 1200-1400 Lunch and rest (for the staff).
- 1400 Harvest *Artemia* and restart new *Artemia* for the next day.
- 1600 Take temperatures, check aeration and make adjustments if necessary. Feed *Artemia* to all rearing tanks (see feeding schedule for amounts to feed each stage). Give pellet feeds to raceways scheduled for this type of feed (see Table 1 for percentage of feed and corresponding age).

Larval-Rearing Tank Preparation Before Use

After harvesting, the larval-rearing tank (Figure 19) is scrubbed thoroughly and then refilled with seawater. Add chlorine to the rearing tank to bring the concentration to 10 ppm (40 grams of chlorine for the 4,000-liter rearing tank). Airstones, tubing and standpipe with screen are also scrubbed and placed in the chlorine solution to kill bacteria and other unwanted organisms. The chlorine solution is allowed to sit in the tank overnight or at least several hours if there is a rush to get the tank started again. The tank is then drained and thoroughly rinsed with filtered seawater and allowed to air dry before refilling and restocking.

The seawater used to refill the larvalrearing tank is only as good as the level of treatment (filtration/disinfection) applied to it. It must be filtered down to one micron for best results. Neglect in this area can prove critical to a batch's survival. Protozoans and other unwanted organisms that can compete with the larvae for air, space and food will take over the tank if filtration is not properly undertaken or there are contaminants of this nature in the algae culture fed to the tank. This final filtration in the Dian Desa Hatchery was accomplished by using a cartridge-type filter with a one micron filter element.

Table 1. Suggested Larval-Culture Sequences and Postlarval Feeding for Yayasan Dian Desa Hatchery, Jepara, Indonesia

Day	Tank	Vol. (T)	Stage	Chaet. (cells/ml)	FEEDING			Pellet %	Water %	TREATMENTS	
					Tetra. (cells/ml)	Art. #/ml				Treflan (ml/T)	Chlor.** ppm
0	ST	0.8	E-N	—	—	—	—	200	—	—	
1	LRT	1	N	—	—	—	—	0	—	—	
2	LRT	1	N6-Z1	50,000	—	—	—	0	20	—	
3	LRT	2	Z1	75,000	—	—	—	0	30	2	
4	LRT	3	Z1-Z2	100,000	20,000	—	—	0	30	—	
5	LRT	3.2	Z2	100,000	20,000	—	—	0	40	—	
6	LRT	3.5	Z3	100,000	20,000	—	—	0	40	—	
7	LRT	3.8	Z3-M1	50,000	20,000	1	—	50	40	—	
8	LRT	3.8	M1	50,000	20,000	1	—	50	40	—	
9	LRT	3.8	M2	Trace	20,000	3	—	50	50	4	
10	LRT	3.8	M3	Trace	20,000	6	—	50	50	—	
11	LRT	3.8	M3-PL	—	20,000	6	—	50	50	6	
12	LRT	3.8	PL1	—	20,000	6	—	50	50	—	
13	LRT	3.8	PL2	—	Trace	6	—	50	50	—	
14	LRT	3.8	PL3	—	Trace	6	—	50	50	—	
15	LRT	3.8	PL4	—	—	6	—	Flush	—	—	
15	RWY	7-12	PL4	—	—	6	—	100	50	*	
16	RWY	7-12	PL5	Trace	—	6	—	100	50	*	
17	RWY	7-12	PL6	Trace	—	5	100%	100	50	*	
18	RWY	7-12	PL7	Trace	—	4	200%	100	50	*	
19	RWY	7-12	PL8	Trace	—	3	200%	100	50	*	
20	RWY	7-12	PL9	Trace	—	2	200%	100	50	*	
21	RWY	7-12	PL10	—	—	1	200%	100	50	*	
22	RWY	7-12	PL11	—	—	0	200%	100	50	*	
23	RWY	7-12	PL12	—	—	0	200%	100	50	*	
24	RWY	7-12	PL13	—	—	0	200%	100	50	*	
25	RWY	7-12	PL14	—	—	0	200%	100	50	*	
26	RWY	7-12	PL15	—	—	0	200%	100	50	*	
27	RWY	7-12	PL16	—	—	0	200%	100	50	*	
28	RWY	7-12	PL17	—	—	0	200%	100	50	*	
29	RWY	7-12	PL18	—	—	0	200%	100	50	*	

* — Use if needed

Also, use Malachite Green (1 ppm) if *Zoothamnium* is noted

**Chloramphenicol (antibiotic)

ST — spawning tank

RWY — raceway

LRT — larval-rearing tank

Chaet. — *Chaetoceros*

Tetra — *Tetraselmis*

The tank is then half filled. A solid, 2-inch PVC standpipe (no screen necessary until water exchange is necessary) is placed in the center of the tank. The drains are checked for leaks. Teflon tape may be required around the standpipe to stop leaks. Airstones are selected so that they will be heavy enough to remain on the very bottom of the tank with air turned on, but the stone must put out a very fine bubble to flow evenly and smoothly to the surface and to the edge of the tank before bursting. Large bubbles should be avoided as they do not help much with the transfer of oxygen to the water in the rearing tank. It is important to have the airstone on the bottom so a "dead" area does not form with H₂S or debris (which can be deadly to larvae or may provide a medium for bacterial growth).

It would be a good idea to let the tank sit for several hours with continuous aeration in case there are chlorine byproducts present, which should be neutralized by the aeration. This will also give you a chance to see if the tank will hold water before you put larvae in it. The tank is maintained on a batch feed basis until the late zoeal stage or until a problem arises (high pH—ammonia) that requires water exchange. Initially, the tank is only half filled with filtered seawater during the naupliar stocking phase. As feed is added, the volume is increased (Photo 51). By the time the larvae are at the late zoeal substage or early mysis, the rearing tank is at its maximum holding and carrying capacity. Less algae is required using this method. Maintaining higher concentrations of algae during the zoeal stages is critical to the success of the batch. A volume



Photo 51. Larval rearing tank approximately one-half full (1 micron filter cartridge on inflow; central, screen standpipe with air collar and 100,000 cells/ml algae).



Photo 52. Series of larval rearing tanks; some covered with plastic during evening hours to keep temperature up.



Photo 53. 4,000-liter rearing tank filled to capacity.

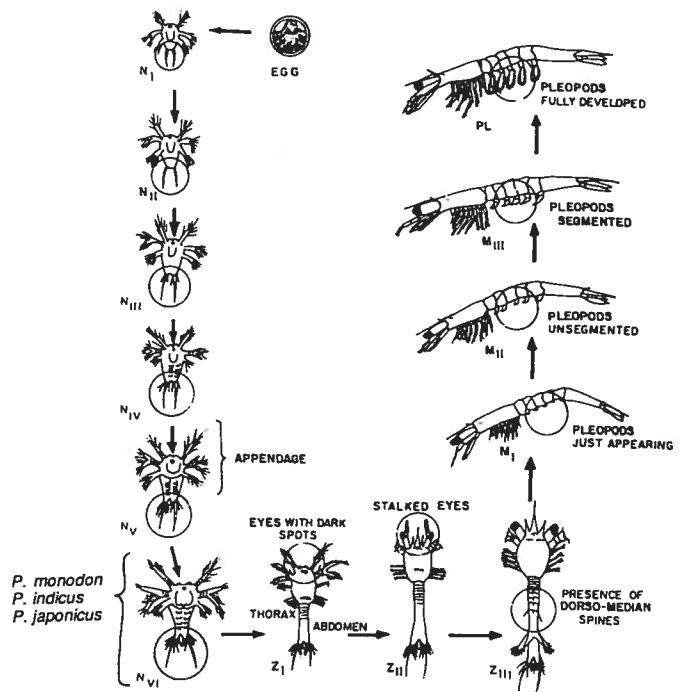

Figure 40. Shrimp Larval Stages (after Motoh, 1979)

recommendation can be found in Table 1 (Nauplii, 1,000 liters volume; Z3-M1, 3,800 liters, etc.).

The goal at the Dian Desa Hatchery was to maintain a *Chaetoceros* feed level for *Penaeus monodon* larvae somewhere around 100,000 cells/ml and to not let the cell concentrations fall below 40,000 cells/ml, especially during the zoeal substages (Table 1). Maintaining these higher cell densities in the mysis substages is not necessary since *Artemia* nauplii are being fed and a 50 percent per day exchange of water is taking place. Approximately 20,000 cells/ml *Tetraselmis* should be maintained in the rearing tank while feeding *Artemia*. There are many reasons for maintaining algae levels, even up to the PL stage (the presence of algae helps maintain ammonia levels within acceptable ranges; algae are still being consumed by the shrimp while metamorphosing from algae-eating to zooplankton-eating; and *Artemia* make a better food source if they have been feeding upon algae, as opposed to being starved). It was not possible to monitor ammonia levels with a simple, inexpensive test kit at Dian Desa. Thus, because of high magnesium and iron levels in the water, the maintenance of some algae in the LRT became even more important.

Much research has been done on the brine shrimp *Artemia* and most studies have shown that the Instar I is an excellent food source. However, when the yolk is depleted, the *Artemia* has developed mouth parts, (after 24 hours) and they must have something nutritious in the water column to feed upon (e.g. algae) or they reach a "starved" state. The animal itself is no longer a good food source for penaeids when in this condition. (See Chapter 3, Larval Staging, Feeding and Observations for more information).

The temperature should be stabilized in the tank be-

fore nauplii are transferred to it. The recommended temperature is 28°C ($\pm 1^\circ\text{C}$) for optimum growth and steady metamorphosis of the larvae through the various stages (Figure 40). The object is to get them through the stages as quickly as possible without stressing them (Photos 52 and 53). A temperature of 26°C is too low. The larvae will continue to metamorphose but at a slower rate. Many bacteria grow better at 30°C. One should consider all of these factors.

Other Environmental Conditions of Importance

Salinity is not as critical as temperature. Salinity ranges of 25 to 36 ppt are probably optimum for larval rearing, but should be kept from fluctuating as much as possible. Salinity readings should be taken once or twice a week unless during a rainy period when fluctuation is likely.

Acidity (pH) should be read daily in the rearing tank. A pH of 7.8 to 8.4 is acceptable, but the optimum pH is 8.0. A pH of 8.4 and above will begin to stress the larvae. The pH was monitored at Dian Desa through a complete larval rearing cycle. The readings remained between 8.0 and 8.13 in the tanks until Mysis III and then dropped, due to incoming seawater dropping below 8.0 to 7.75. Some mortality was noted but was not easily attributable to the drop in pH below the optimum range. Again, maintenance of algae in the LRT even during the M1 to PL4 stages has proven valuable. When pH readings of incoming seawater were below 7.8, the addition of *Tetraselmis* cultures with pH readings of 9.0 helped to offset these low pH levels in the LRT. A pH of less than 7.8 has been attributed or associated with C_4H metabolism problems, i.e. molting, exoskeleton development.

In most hatcheries around the world, ammonia nitrogen is also an important parameter to watch in the rearing tank. Ammonia and nitrite may become critical and lethal in the late zoeal stages and mysis-to-postlarval stages when *Artemia* are being fed. Lethal ammonia levels are thought to be dependent on the pH, salinity and temperature levels. The 96-h LC50 of ammonia and nitrite on *P. monodon* postlarvae (PL6) are considered to be 11.51 mg/L ammonia-N (Chin and Chen, 1987) and 13.55 mg/L nitrite-N (Chen and Chin, 1988b). Larval penaeids are very sensitive to nitrite. *P. monodon* has a progressive increase in nitrite tolerance as the larvae metamorphose from the nauplius to the postlarval stage. The LC 50s for nitrite on nauplii, zoea, mysis and postlarvae are 5.0, 13.2, 20.6 and 61.9 mg/L $\text{NO}_2\text{-N}$, respectively. A safe level of nitrite is estimated at 1.36 mg/L for PLs and 0.11 mg/L for nauplii (Chen and Chin, 1988a). Generally, it is hoped that ammonia nitrogen levels can be contained below 25 microgram atoms per liter (a small fraction of 1 ppm). Ammonia and nitrite levels should be monitored at least once each day in the hatchery. Nitrogenous waste products from protein digestion can accumulate to dangerous levels in the larval rearing tanks. Like other animals, shrimp use the nitrogen component of digested proteins (the amino group, NH_2) to build their own proteins, but they cannot metabolize the nitrogen component for energy.

When proteins are metabolized for energy, the amino group is cleaved off and is directly excreted as ammonia (NH_3). A similar process also occurs during bacterial

decomposition of proteins and other nitrogenous compounds within uneaten feed and waste. Ammonia is an end-product of protein catabolism, and it comprises 40 to 90 percent of the nitrogenous excretion in crustaceans (Chen and Chin, 1988b). High concentrations of ammonia and nitrite can be detrimental in the hatchery. Ammonia and nitrite are common in hatcheries and attain levels up to 0.808 mg/L ammonia-N (un-ionized and ionized ammonia) and 0.118 mg/L nitrite-N even with 30 percent water replacement per day (Chen *et al.*, 1986). Ammonia released by shrimp excretion and bacterial decomposition is either absorbed as a nutrient by algae or oxidized, first to nitrite (NO_2) and then to nitrate (NO_3) by nitrifying bacteria, *Nitrosomonas* and *Nitrobacter*. In intensive shrimp larval-rearing tanks, however, ammonia and nitrite can accumulate to toxic levels periodically. Nitrate is not toxic at levels usually encountered in LRTs. Two recent references on this topic are Chin and Chen, 1987, and Chen and Chin, 1988a.

Total ammonia and nitrite can be monitored with inexpensive test kits (unless there is interference due to the presence of magnesium hardness) and can be regulated with water exchange. Ammonia exists in both a toxic un-ionized form (NH_3), predominantly at higher pHs, and a non-toxic, ionized form (NH_4^+), primarily at low pH. The ionized form is not considered toxic since its ionic charge prevents it from passing across the cell membrane of the gills.

To determine the concentration of un-ionized ammonia, measure total ammonia and multiply that value by the percentage that exists in the toxic un-ionized form (see chart below). Recommended safe levels of un-ionized ammonia ($\text{NH}_3\text{-N}$), nitrite ($\text{NO}_2\text{-N}$) and nitrate ($\text{NO}_3\text{-N}$) are 0.1, 0.1 and 200 mg/l, respectively (Chamberlain, 1988).

Percentage Un-ionized Ammonia in Aqueous Solution at Different pH Values and Temperatures (Boyd, 1988)

pH	Temperature (C)		
	26	28	30
7.8	3.68	4.24	4.88
8.0	5.71	6.55	7.52
8.2	8.75	10.00	11.41
8.4	13.20	14.98	16.96

If some form of oxidant gas, such as ozone, is maintained at a low residual level in the larval-rearing tank (i.e. introduced through aeration), it can help to maintain NH_3 (un-ionized ammonia) and nitrite with acceptable ranges (Reid, 1980). Ozone is directly toxic to aquatic organisms, therefore the residual level must be considered if used. Ozone is discussed further in this chapter under Filtration, Sterilization and Disinfection.

High pH readings or ammonia readings can be dealt with by draining and replacing enough of the culture water and algae to bring the readings back within acceptable ranges. High pH levels were not a problem at the Dian Desa



Figure 41. Naupliar substages of *Penaeus duorarum*. a₁ – first antenna; a₂ – second antenna; en – endopod; ex – exopod; fr – frontal organs; fu – furca; lm – labrum; md – mandible; mx1 – first maxilla; mx2 – second maxilla; mxp1 – first maxilliped; mxp2 – second maxilliped; o – ocellus; sc – scaphognathite (from Dobkin, 1961).

- a) Nauplius I: Body pear-shaped.
- b) Nauplius II: 1 long, 1 moderate and 1 short terminal setae on 1st antennae.
- c) Nauplius III: 2 distinct furcal processes, each with 3 spines.
- d) Nauplius IV: Each furcal process with 5 spines (1); segmentation of appendages apparent (2); 1st and 2nd maxillae and maxillipeds present (3).
- e) Nauplius V: Body more or less depressed; swollen knoblike structures at bases of mandibles present (1); frontal organs present (2).

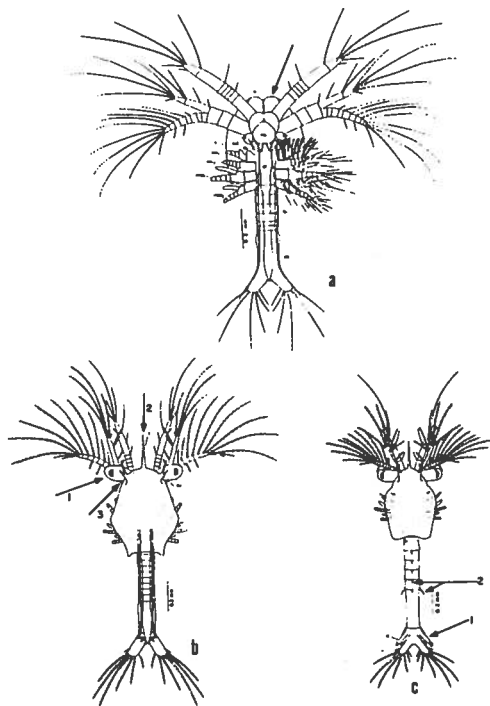
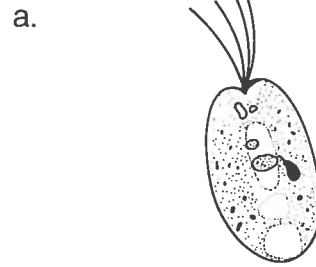

Figure 42. Zoeal substages of *Penaeus duorarum*. ab – abdomen; c – carapace; dt – digestive tract; e – eye; la – labrum; md – mandible; mx1 – first maxilla; mx2 – second maxilla; mxp1 – first maxilliped; mxp2 – second maxilliped; r – rostrum; su – supraorbital spine; th – thorax; u – uropod (from Dobkin, 1961).

- a) Zoea I: Eyes stalked (1); rostrum present (2); supraorbital forked spines present (3).
- b) Zoea II: Pair of biramous (doubly branched) uropods developed (1); spines appear on abdominal somite (2).



Tetraselmis sp. (10-15µm)



Isochrysis sp. (3-5µm)

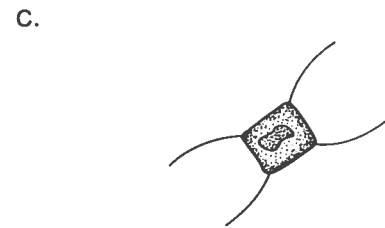

Chaetoceros sp. (4-6µm)

Figure 43a. Some Commonly Cultured Microalgae

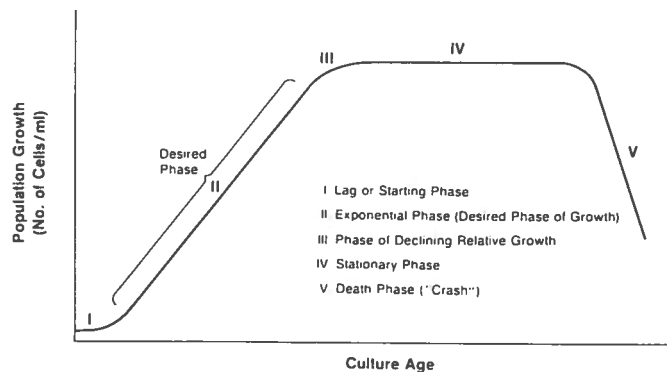

Figure 43b. Typical Phytoplankton Culture Growth

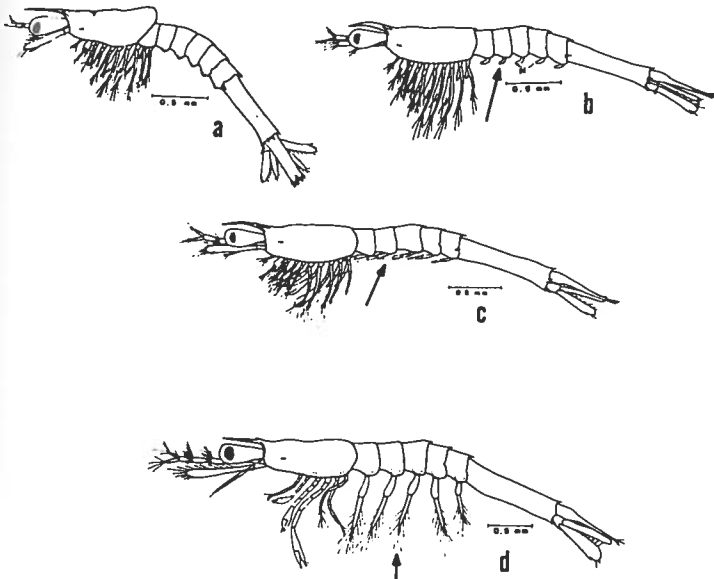
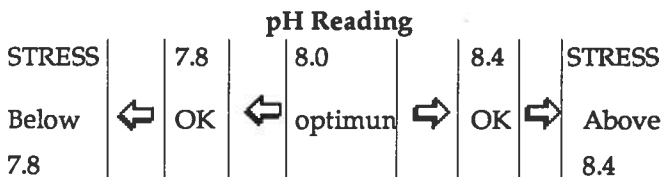

Figure 44. Mysis and Postlarval substages of *Penaeus duorarum*: p1 – pleopod (from Dobkin, 1961).

- a) Mysis I: Shrimp-like body structure.
 b) Mysis II: Pleopod buds apparent but unsegmented.
 c) Mysis III: Pleopods elongated and segmented.
 d) Postlarva I (PL₁): Swimming setae present on pleopods.

Hatchery, at least during July and August. Low pH readings (below 7.8) posed a problem only for a few days, after which the inflow pH readings returned to 8.0 to 8.2. Water quality management at Dian Desa should include pH and be monitored daily. Readings below 7.8 could cause periods of stress and even mortality in cultured larvae.



Larval Staging, Feeding and Observations

Penaeid shrimp pass through three larval stages (Figure 40), nauplii, zoeal and mysis, before reaching the postlarval stage. As nauplii (Figure 41), they have undeveloped mouth parts and feed upon their yolk within the body. After passing through the six naupliar stages, *Penaeus monodon* metamorphoses to the zoeal stage (Figure 42). It is a dramatic change and it is not at all unusual to lose 24 percent of the larvae during this transition. The nauplii substages take approximately 48 hours (ranging from 36 to 51 hours depending on the temperature). Time periods of larval stages may be seen in Table 1 (Suggested Larval Culture Sequences) as well as feeding information.

Daily observations of the larvae should include looking at the following characteristics while staging. Use the microscope, not the naked eye, for these observations. Look for debris on the setae, fecal threads, deformities, bacteria and protozoans, as well as for other problems such as fungi and ciliates.

Zoea feed on phytoplankton (microscopic plants); see Figure 43a for some commonly cultured microalgae. An

Table 2. Classes and Species of Microalgae Presently Under Culture

Class	Species
Bacillariophyceae	<i>Skeletonema costatum</i> , <i>Thalassiosira pseudomonas</i> , <i>T. fluviatilis</i> , <i>Phaeodactylum tricornutum</i> , <i>Chaetoceros calcitrans</i> , <i>C. curvisetus</i> , <i>C. neogracile</i> , <i>C. simplex</i> , <i>Ditylum brightwelli</i> , <i>Scenedesmus</i> sp.
Haptophyceae	<i>Isochrysis galbana</i> , <i>Isochrysis</i> sp.(Tahiti), <i>Dicrateria inornata</i> , <i>Cricospaera carterae</i> , <i>Coccolithus huxley</i>
Chrysophyceae	<i>Monochrysis</i> sp.
Prasinophyceae	<i>Pyramimonas grossii</i> , <i>Tetraselmis suecica</i> , <i>T. chunii</i> , <i>Micromonas pusilla</i>
Chlorophyceae	<i>Dunaliella tertiolecta</i> , <i>Chlorella autotrophica</i> , <i>Chlorococcum</i> sp., <i>Nannochloris atomus</i> , <i>Chlamydomonas coccoides</i> , <i>Brachiomonas submarina</i>
Chryptophyceae	<i>Chroomonas salina</i>
Cyanophyceae	<i>Spirulina</i> sp.

area of major concern in most penaeid larval-rearing systems is the provision of a suitable food source. Unicellular microalgae has proven appropriate for a variety of culture situations. Microencapsulated dried diets, such as the one being used at the Dian Desa Hatchery have also been fed (as a supplemental food) with some success, but these are not widely used by commercial hatcheries. Further testing and comparative studies need to be made at this specific location before the practice is adopted or used on a routine basis. Dried diets are meant to be fed along with algae, not in place of algae. The fats in the diet easily become rancid if not kept refrigerated. Also, adding dried or inert diets means "dead" material is being placed in the tank; this provides a good substrate for bacterial growth, as opposed to the addition of live algae. These diets should be fed only if there is a shortage of algae and there is no other alternative.

The Dian Desa Hatchery feeds *Chaetoceros* (a small, brown diatom) and *Tetraselmis* (a larger, green, flagellated algae) on a routine basis through the zoeal and mysis stages (Figure 43a). This combination of a centric diatom and green flagellate is widely used in the industry with good results. *Chaetoceros* ranges in size between 4 and 6 microns, while *Tetraselmis* is 10 to 15 micrometers in diameter. Classes and species of microalgae presently under culture are listed in Table 2. Culture techniques are well established for these species and should not be deviated from to any great extent.

Zoea feed indiscriminately, but must have food small enough to enter the mouth when they encounter it while constantly swimming. Food levels must be maintained in

Figure 45a Stages of *Artemia* Development
(Drawn From Photo by Sorgeloos, 1979)

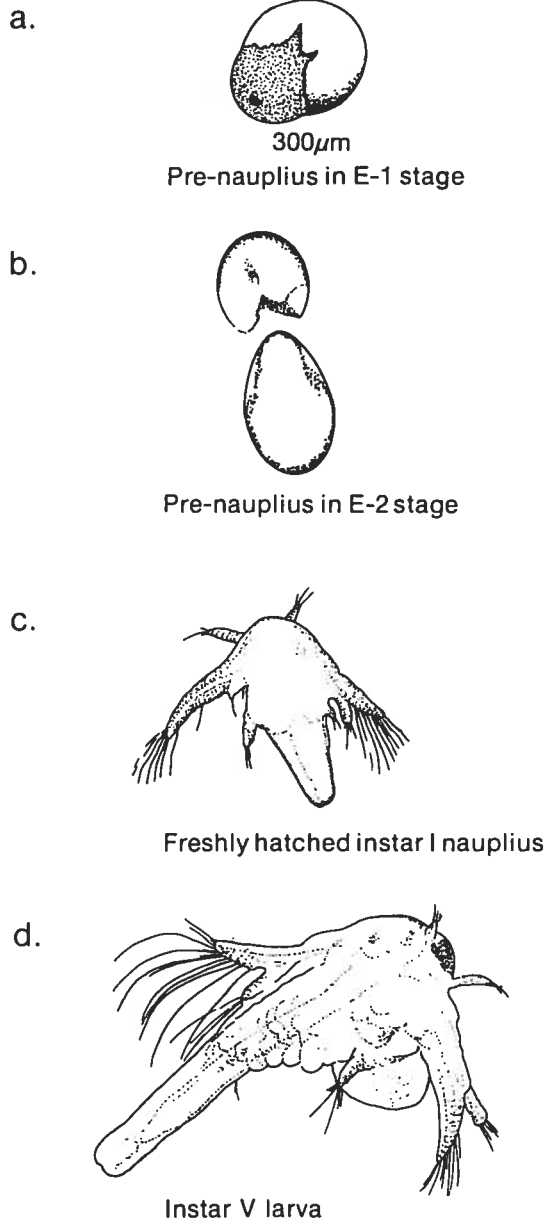

sufficient quantities to keep them satisfied. During the later zoeal substages, the use of a smaller algal cell may not satisfy their increasing appetite. The hatchery needs to feed a larger algal cell at the same cell densities or quantities for more efficiency. The food also must be kept in suspension for it to be available to the larvae; therefore, gentle aeration is used.

Larvae metamorphose through three zoeal substages in approximately 120 hours, averaging 36 to 48 hours in each stage, before molting to the mysis stage. In the mysis stage the larvae (Figure 44) look more like adult shrimp and one can stage or tell the difference between the zoeal stage and the mysis stage without the use of the microscope. Mysis larvae will begin to stay in one place or even

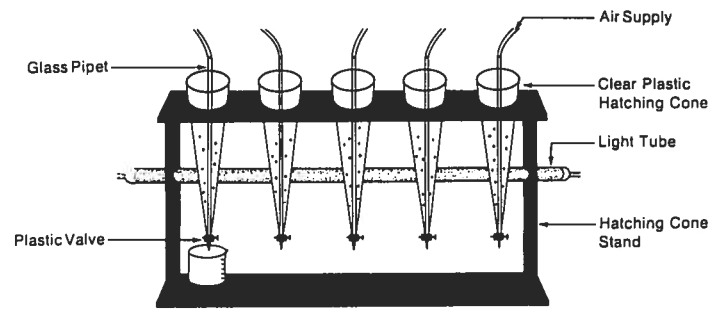

Figure 45b. *Artemia* Hatching Cones

swim backwards and flip occasionally.

Mysis larvae are capable of more vigorous swimming and can seek out, capture, grasp and hold food consisting of a variety of zooplankton as well as *Artemia* nauplii. Mysis substages last 24 hours each when held at 28° C. Twenty-four hours also determine the difference between PL1 and PL2, etc. *Artemia* are fed to the shrimp as soon as the shrimp are able to grasp and consume large food particles. This larger food should be fed at late zoeal or early mysis.

Large algae cells alone are not sufficient food for mysis larvae. Shrimp larvae in the late mysis stage have been known to eat up to 50 *Artemia* nauplii per day, and larval shrimp at Dian Desa have shown these same feeding habits.

Brine shrimp (*Artemia*) are collected in cyst form from salinas located worldwide and sold commercially. They come in a sealed tin can. Once the can is opened, the cysts should be kept dry and free of any exposure to humidity. The cyst hatch will be greatly affected if not kept in a dessicator or other dry container. Most of the time the can will come with a plastic, resealable lid. This is probably adequate if the can is kept in a cool, dry place and the contents are used rapidly. Do not place *Artemia* cysts in the algae lab. (See Figure 45 for the stages of *Artemia* development.) Refer to Treece and Yates, 1988, for a review on *Artemia* used as food in hatcheries.

Other organisms have been used to feed the mysis larvae, but none have been quite as effective or as easy to culture and feed as the *Artemia* nauplius. *Artemia* meets all the requirements of a good, live food source. It is sufficient nutritionally, although variations in the different strains of brine shrimp have been shown. Copepods and nematods have also been used, but have not proven to be a consistent economical success for hatchery operations. Micro-encapsulated diets are being pushed by producers, but actual, proven, long-range hatchery successes are very few. These diets are to be avoided and used only as a research and development project until they are shown to be economically and otherwise justified. Some results have shown that postlarvae are larger when supplementally fed microencapsulated feed than larvae fed only algae and *Artemia*.

Artemia cysts may have much bacteria on the outer shell and should be disinfected or hydrated in a chlorine solution (5 to 10 ppm chlorine and either freshwater or

Figure 46
Counting *Artemia* when concentrated

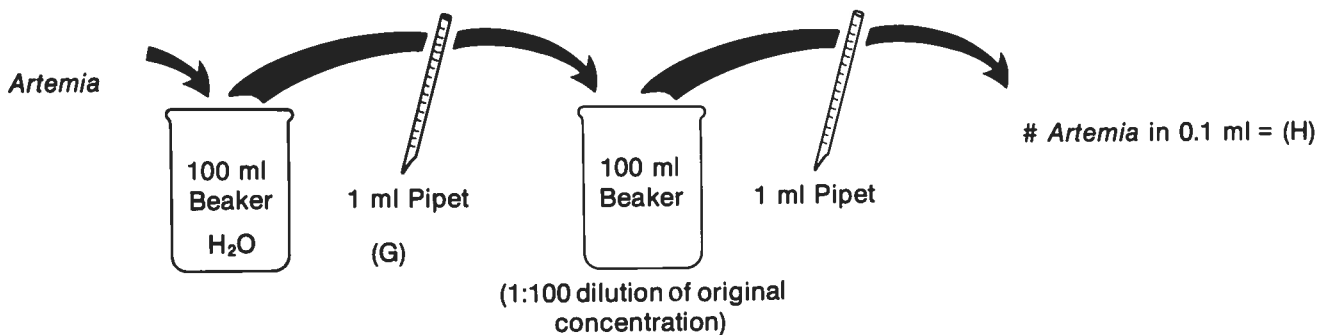

$$(G) = (H) \times 1,000$$

$$H \times 10 = (\# \text{ *Artemia* in 1 ml})$$

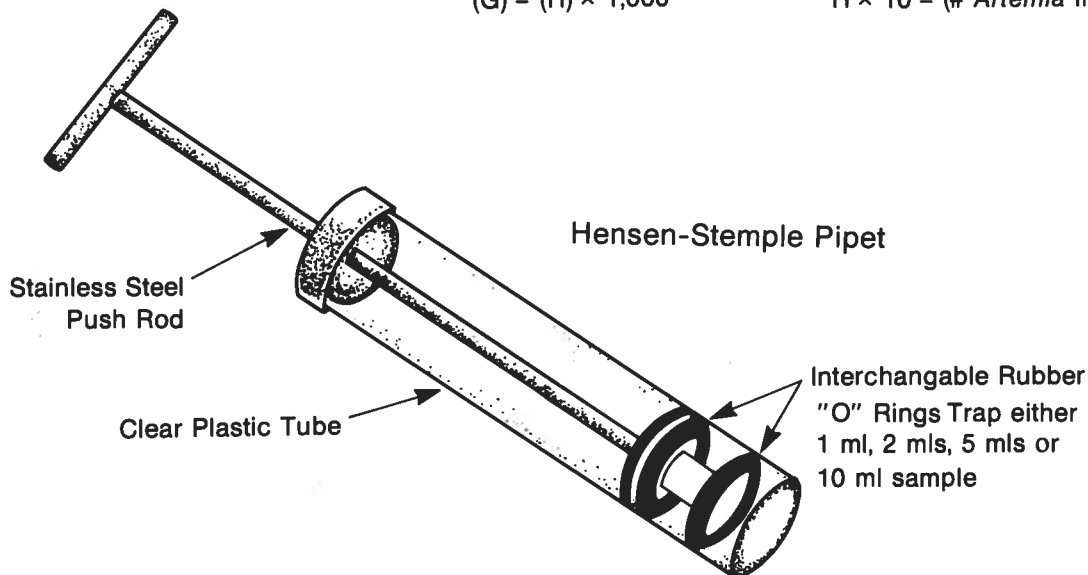

seawater). Aeration should be applied in the hydrating container so that all the cysts are exposed to the chlorine solution. The cysts should be hydrated or disinfected for approximately one hour, then rinsed thoroughly until all the chlorine is gone. The cysts should then be placed in full-strength, filtered seawater and aerated near a strong or intense light source for 24 hours. For best hatching results, place 5 grams of cysts for every liter of seawater. Depending on the strain of cysts, one should expect between 200,000 to 300,000 nauplii from each gram of cysts. A 1 liter cone can be used for small numbers of *Artemia* (See Figure 45b). For larger requirements, a 5-gallon or 19-liter clear glass or plastic drinking water bottle may be used to hatch the *Artemia*.

Harvesting works best if the aeration is removed and the solution is allowed to sit for approximately ten minutes. The unhatched cysts should float and the freshly hatched nauplii will sink to the bottom of the container or will swim toward the light source, and can be collected by siphoning (Photo 54). One of the easiest ways to hatch and harvest is in a conical container (clear plastic), with a valve

at the bottom. Freshly hatched nauplii sink and can be drained out of the container by opening the valve or stopcock (Figure 45b).



Photo 54. Siphoning off freshly hatched *Artemia* nauplii after settling (note the stratified layers).

After harvesting and concentrating nauplii, a subsample can be taken and the number of nauplii counted between two marks on a .01-ml graduated pipette, or some other simple method of counting can be used. Extrapolation will give the total number of nauplii concentrated in the harvest container (see Figure 46 for other methods of counting *Artemia*). Freshly hatched nauplii should be aerated and fed to the shrimp larvae as soon as possible. If too many nauplii have been hatched, they can be saved until the next day by placing them in a refrigerator at 4°C, with little or no nutritional loss or mortality. Some *Artemia* nauplii can be frozen or stored in a brine solution and held as back-up feed when a poor hatch occurs. The frozen nauplii should be fed only in an emergency. They are dead and will be quickly attacked by bacteria and protozoans in the rearing tank. Their extra weight also requires vigorous aeration to keep them suspended so that they will be accessible to the larvae.

The recommended *Artemia* nauplii feeding regime for the Dian Desa Hatchery is as follows:

LARVAL STAGE	ARTEMIA DENSITY/ml (Fed by Volume)
Late Z3-Mysis I	1
Mysis I-Mysis II	3
Mysis II-Mysis III	6
Mysis III-Postlarvae	6

One way to determine the amount of *Artemia* to be added to a rearing tank is by following these six easy steps:

1. Number of *Artemia*/ml required = A
2. Present density in larval-rearing tank (# *Artemia*/ml) = B
3. $A - B = C$
4. $C \times (\text{Volume of larval-rearing tank in ml}) = D$
5. Number of *Artemia*/liter in hatching container = E
6. $D/E \times 1000 = \# \text{ mls of } Artemia \text{ to be added to LRT}$

Decapsulation of the cysts is a standard procedure for the Dian Desa Hatchery. This is the best way to feed *Artemia* to penaeids. The technique for decapsulation has been described in many places in literature and will not be described here (See Sorgeloos *et al.*, 1983; Sorgeloos, 1986, and Treece and Yates, 1988).

A small amount of algae is maintained in the rearing tank even during the mysis or *Artemia* feeding period, so that second-day-old *Artemia* will be a good food source when eaten by penaeid larvae.

Artemia Enrichment

Artemia strains differ in size and nutritional quality, particularly in content of HUFA. In 1986 Leger *et al.*, found that strains containing greater than 4 percent of fatty acids at 20:5 n3 yield significantly better growth than *Artemia* with less than 3 percent 20:5n3. The premium quality *Artemia* with high hatching rates, small size and greater HUFA levels are relatively expensive and sometimes difficult to find in quantity. As an alternative, a hatchery can purchase less expensive *Artemia* with little or no HUFAs and enrich them. The following is a simplified formula for *Artemia* enrichment, provided by Paul Olin of the University of Hawaii at Manoa, Coconut Island Shrimp Hatchery.

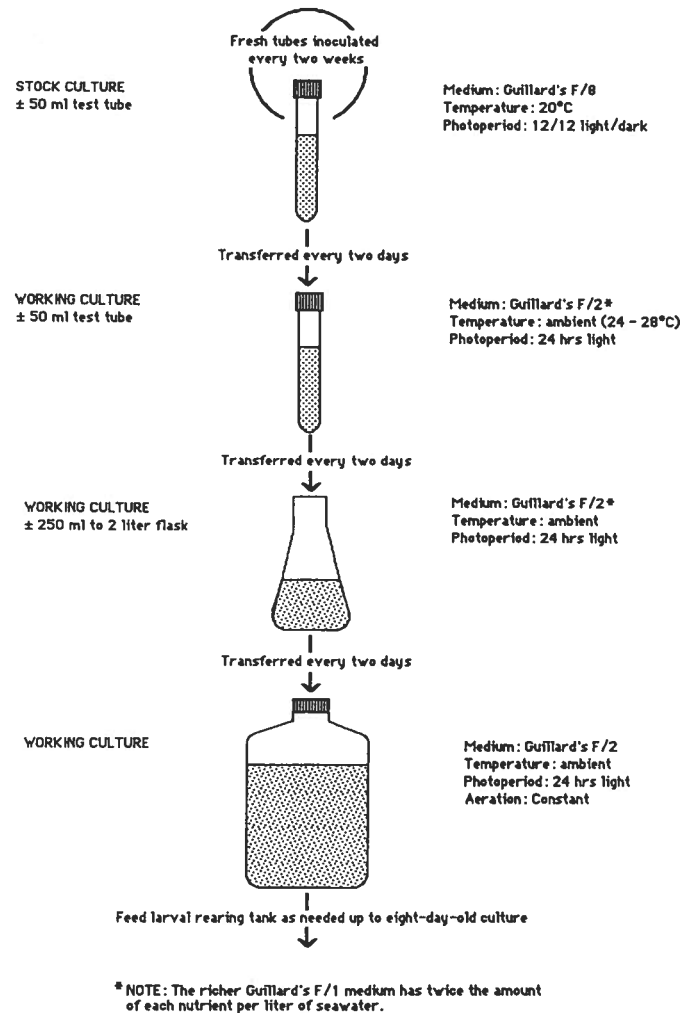

Figure 47. Typical Cycle Used in Algae Culture

Formula

Ingredients

- 800 ml deionized water
- 160 ml cod liver oil, or other high omega fish oil
- 4 egg yolks
- 30 gr unflavored gelatin
- 10 gr Vitamin premix, including E, C and B complex
- 1 gr β-Carotene

Procedure

1. Dissolve gelatin in 800 ml boiled deionized water and let cool to 40°C.
2. Mix the oil in a blender on the highest setting for 30 seconds while adding β-carotene.
3. While blender is still on, add vitamins and egg yolks. Finally, add gelatin and blend for 90 seconds.
4. Store the product covered in the refrigerator.

For Use with Hatching *Artemia*

Use about .5 ml enrichment diet per liter of incubation water (assuming 2 gr dry cysts/liter incubation water) after 24 hours hatching time, and another .5 ml enrichment diet per liter two hours before harvesting. Harvest before *Artemia* become too large for predator larvae.

For Use with Hatched Separated Artemia (in seawater)

Use about .5ml enrichment diet per liter of separated *Artemia* (assuming a density of 100 to 150 *Artemia* per ml) for not less than four hours. Aerate the *Artemia*/diet mix during the enrichment process. Cooling the water with ice may slow the rate at which the *Artemia* grow during the enrichment process if size is critical to predator larvae.

The drawback to this procedure is that *Artemia* grow very rapidly and metamorphose to second instar metanauplii and can become too large for late zoea and early mysis penaeid shrimp to catch and consume. The recommended solution is to use premium quality, newly hatched *Artemia* for penaeid zoeal and mysis stages and then switch to enriched metanauplii *Artemia* as food for the postlarval penaeids. For further information, see Sorgeloos *et al.*, 1986 (Manual for the Culture and Use of Brine Shrimp *Artemia* in Aquaculture).

Algae Culture (in Support of Larval Rearing)

The purpose of the algal mass-culture system is to provide a dense "starter" culture (for the inoculation) of the desired species of algae that are known to satisfy the nutritional requirements of penaeid shrimp larvae. This is accomplished by producing "pure" algal cultures in the laboratory in enriched seawater medium under controlled environmental conditions, and using these cultures to inoculate still larger cultures, which are eventually used as feed (Photos 55 and 56, and Figure 47).

The algal cultures are produced daily on a production-line basis by transferring small cultures at intervals into larger growth vessels containing new media (Figure 47). The transfers are made according to a schedule of inoculations that provide alternate food organisms (or a mixture) to the shrimp larvae. The next stage in the algal-culture system is the carboy stage. Commercial shrimp hatcheries generally use much larger culture vessels, tanks or even pools as their last stage in the algal-culture system before feeding to penaeids.

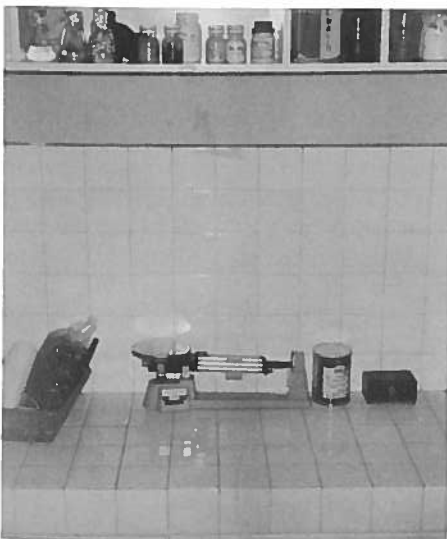

Photo 55. Laboratory work bench, with balance and chemical storage.



Photo 56. Algae lab behind closed doors in air-conditioned room.

The classes and species of microalgae presently cultured for aquaculture purposes are listed in Table 2.

The algal species most often used in commercial hatcheries are the naked flagellates (both green and brown) and a diatom of the genus *Chaetoceros*. One common strain used is the Tahitian strain of *Isochrysis* which tolerates high temperatures (up to 30° C) and strong light. It is a small spherical shaped flagellate, approximately 3 micrometers in diameter, without a thick cellular wall, capable of self-locomotion (by means of flagella). The absence of a heavy cell wall makes it a suitable food for larval herbivores, but *Isochrysis* is low in HUFA content. The best combination of algal species has been shown to consist of *Chaetoceros* and *Tetraselmis*. The diatom *Chaetoceras* has the qualities of rapid growth, high HUFA content and because it is larger than *Isochrysis*, has a wider application in Penaeid larviculture.

Tetraselmis is a green flagellate ranging from 10-15 micrometers in diameter. It is good to feed this species later in the penaeid larval cycle to help fulfill their ever-increasing appetites. Fed in combination with the brown flagellate, it provides a "well rounded" diet for larvae (small-cell-brown and large-cell-green). Some strains of *Tetraselmis* have a tendency to settle out or grow on the walls of the culture vessel and should be discarded if this begins to happen with one of the cultures.

Growth Medium

For simplicity, Guillard's F/2 medium can be purchased in a pre-mixed, concentrated form from a local aquaculture supply and chemical dealer-distributor. See Table 3a for the make-up of Guillard's F/2 algal culture medium.

Guillard's method is most often used with the greatest success in hatcheries. Some other methods used to culture algae are: Allen's Medium, Artificial Seawater Medium, AS100 Medium, Bold's 3N, Bristol's and Bold's 1NV Bristol's, Bristol's Solution, Chu's Medium, Desmid agar, "Double Strength Seawater," Erdschreiber Solution, ES Enrichment for Seawater, Soil-water Medium, Tres-Buffered Medium, (See Starr, 1978, for descriptions of each of these methods). Fritz Chemical also sells an "Algae Food."

Examples of other growth medium methods used at various locations around the world can be seen in Table 3b (The Philippine's Method of Algae Culture) and Table 3c (Indonesian Method of Algae Culture). Another growth medium example used in a commercial hatchery, a "community" method of algae production used by Continental Fisheries, Ltd. Panama City, Fla., USA, is described as follows.

Obtaining Cultures

One place to obtain the algae cultures *Chaetoceros*, *Tetraselmis chuii*, *Isochrysis* sp. (Tahiti) and others is

Table 3a. Guillard's F/2 Algal Culture Medium (Composition per liter of seawater).

Major Nutrients	Final Concentration (mg/l sea water) Note #1	Stock Solution Preparation
NaNO ₃ (sodium nitrate)	75 mg	Nitrate/Phosphate Solution
NaH ₂ PO ₄ · H ₂ O (sodium phosphate) NaH ₂ PO ₄ to 1 liter DI	5 mg	Working stock: add 75 g NaNO ₃ + 5 g
Na ₂ SiO ₃ · 9H ₂ O (sodium silicate)	30 mg (See Note #2)	Silicate Solution Working stock: add 30 g Na ₂ SiO ₃ to 1 liter DI
Trace Metals		
Na ₂ · EDTA (sodium EDTA)-see Note #3	4.36 mg	Trace Metal/EDTA Solution
CoCl ₂ · 6H ₂ O (Cobalt Chloride)	0.01 mg	Primary stocks: make 5 separate stocks in 1-liter volumes
CuSO ₄ · 5H ₂ O (Cupric sulphate)	0.01 mg	10.0 CoCl ₂ /1 DI, 9.8 CuSO ₄ /1 DI, 180 g MnCl ₂ /1 DI
FeCl ₃ · 6H ₂ O (Ferric Chloride)	3.15 mg	6.3 g Na ₂ MoO ₄ /1 DI, 22.0 g ZnSO ₄ /1 DI
MnCl ₂ · 4H ₂ O (Manganese Chloride)	0.18 mg	Working stock: add 1 ml of each primary stock solution
Na ₂ MoO ₄ · 2H ₂ O (Sodium Molybdenum Oxide)	0.006 mg	+ 4.35 gf Na ₂ C ₁₀ H ₁₄ O ₈ N ₂ + 3.15 g FeCl ₃ to 1 liter DI
ZnSO ₄ · 7H ₂ O (Zinc sulphate)	0.022 mg	
Vitamins		
B ₁ (Thiamin HCL)	0.1 mg	Vitamin Solution
Biotin	0.5 µg (microgram)	Primary stock: add 20 g thiamin HCl+0.1 g
B ₁₂ (Cyanocobalamin)	0.5 µg (microgram)	biotin + 0.1 g B12 to 1 liter DI Working stock: add 5 ml primary stock to 1 liter DI

*Note #1—To obtain the final f/2 enrichment, add 1 ml each of the four working stock solutions per liter of seawater.

Note #2—Silicate may be omitted for species other than diatoms.

Note #3—EDTA is ethylenediaminetetraacetic acid (a white crystalline acid used as a chelating agent).

Best form is disodium salt (powder) which is easier to dissolve into distilled water. This form of EDTA=(ETHYLENEDINITRILLO) TETRAACETIC ACID = C₁₀ H₁₄ O₈ N₂ Na₂ · 2H₂O, analytical reagent grade is preferred for use in the hatchery. EDTA is the most widely used chelate in marine media, and is readily metabolized by microbes. The free acid is insoluble in water, but freely soluble in a solution containing 2 molar equivalents of NaOH. The disodium salt (Na₂EDTA · 2H₂O) is readily soluble and has a pH of 4.5 to 5.0. It is marketed as Versene (Fisher Scientific Co., 711 Forbes Ave., Pittsburgh, Pa., USA, 15219 or 8555 Devonshire Rd., Montreal 307, Quebec, Canada) or as Sequestrene (Carolina Biological Supply Co., 2700 York Rd., Burlington, N.C., USA 27215). Consult Stein (1973) for further information on EDTA.

Table 3b. The Philippines Method of Algae Culture

- A. Outdoor mass culture of selected algae
1. Place filtered seawater in culture tank
 2. Fertilize with 100 g of 46-0-0 (N-P-K) or urea and 10 g of 16-20-0 inorganic fertilizer per ton of seawater
 3. Add 50-100 l algal starter per ton of seawater and aerate
 4. Harvest algae after one or two days when blooming occurs; this is indicated by a brownish color for diatoms (*Skeletonema* or *Chaetoceros*) and greenish color for *Tetraselmis*.
- B. Outdoor mass culture of mixed diatoms
- Mixed diatoms (*Chaetoceros*, *Rhizosolenia*, *Thalassiosira*) are found in seawater. Mass culture of these can be done using this method:
1. Place unfiltered seawater in algal tank
 2. Fertilize with 100 g to 46-0-0 and 10 g of 16-20-0 per ton of seawater
 3. Aerate and leave for 2 or 3 days until water turns brown, indicating mixed diatom population bloom. This can be used for feeding or as starter for next culture.
- Some diatom species, however, are available only at a certain season, thus, other species that bloom may not be useful.

Table 3c. Indonesian Method of Algae Culture

Chemical	Concentration	Liters Seawater				
		1 Add (g)	3 1/2 Add (g)	50 Add (g)	1000 Add (g)	2000 Add (g)
1. UREA	100 ppm	0.1	0.35	5	100	200
2. TS P. (Trisodium phosphate)	50 ppm	0.05	0.175	2.5	50	100
3. Z A (Zinc acetate)	25 pp m	0.025	0.0875	1.25	25	50
4. Fe Cl ₃ (Ferric Chloride)	3.5 pp m	0.0035	0.01225	0.175	3.5	7
5. EDTA	0.5 pp m	0.0005	0.00175	0.025	0.5	1

from the culture collection at The University of Texas at Austin (Dr. Jeff Zeicus, Department of Botany, Austin, Texas, U.S.A. 78713-7640 512/471-4019). The charge per culture is \$10.00 U.S. for University-affiliated programs and \$20.00 U.S. for private companies. Commercial algae culture suppliers, local government-run hatcheries or university research facilities can also supply cultures. Other supplies are: the Center for Culture of Marine Phytoplankton (CCMP) in Maine, U.S.A. tel. (207) 633-2173. A two-week notice is required. *Chaetoceros* clone CCMP 1318 and *Terraselmis* clone CCMP 882 are available for \$45/research and \$U.S. 90/commercial; and Carolina Biological Supply, N.C., U.S.A.

One may contact a nearby hatchery and obtain a culture or one may choose to isolate a particular species from nearby waters and use it for culture. Local species have advantages of being resistant to conditions specific to the area and there should be an endless supply in case further isolation is required in the future. The technique for isolating species has been thoroughly described in literature and is not discussed here (See Fox, J.M., 1983 CRC Manual).

Figure 43a (in the section on larval rearing) depicts some of the more commonly cultured microalgae and their relative sizes.

Commercial Application and Community Method of Algae Production used by Continental Fisheries, Ltd., Panama City, Florida

A phytoplankton culture is necessary to provide the protozoa with a suitable food. The community method is used to produce a phytoplankton culture in the larval-rearing tank. There are three factors that determine the effectiveness of this method: the phytoplankton inoculum, fertilizers and lighting. The phytoplankton in the natural seawater in the larval-rearing tank is not sufficient to be used as an inoculum; instead, phytoplankton blooms from the outdoor tank and carboys are used as an inoculum. Fertilizers are composed of commercial grade feed urea (46 percent nitrogen) (Archadian Corp., Memphis, Tenn., USA), laboratory grade sodium phosphate dibasic (Fisher Scientific Company, Fair Lawn, N.J.) and laboratory grade sodium silicate (Fisher Scientific Company). Lighting is provided by 16 fluorescent bulbs (40-watt).

The community method is also used to produce a phytoplankton bloom in outdoor tanks. Two metric tons of fresh seawater from St. Andrews Bay, Fla. were added to the outdoor tank and 300 grams of urea, 15 grams of sodium phosphate dibasic and 15 ml of sodium silicate were added at the same time. An airstone was used to provide strong aeration and circulation in the tank. Under normal weather conditions, the color of seawater in the tank turned yellow-brown within a day or two. This indicated an increase of phytoplankton in the tank. Eight tons of fresh seawater were added after the color of the culture medium was yellow-brown. The color of the medium turned dark brown within two days after adding seawater, which indicated a phytoplankton bloom. *S. costatum* was found to be the dominant species of the bloom. The phytoplankton bloom in the outdoor tank was then ready to be used as an inoculum for the larval-rearing tank and neighboring outdoor tanks.

Two metric tons of the phytoplankton bloom from the outdoor tank were pumped into the larval-rearing tank when shrimp larvae were in the nauplius stage. Fertilizers, at the same dosage used in the outdoor tank, were added and continuous lighting provided. The phytoplankton bloom in the rearing tank occurred about the same time that the nauplii molted to the protozoal stage. The phytoplankton bloom from outdoor tanks was added periodically to the rearing tank to maintain the bloom.

The phytoplankton bloom in the outdoor tank lasts only a few days. The neighboring outdoor tanks are inoculated and fertilized to produce new phytoplankton blooms and provide a continuous supply of plankton for the rearing tank.

T. chuii, *I. aff. galbana* and *Chlorella* sp. are each monocultured in a 20-liter carboy to provide a supplemental inoculum. Stock cultures are put into 2800-ml pyrex flasks, which contain 2000 ml of sterilized, boiled, 1 micron-filtered seawater. Guillard's F/2 medium is added at the same time of the inoculation but silicate is omitted. The dosage of major nutrients and trace metals is 1 ml per liter of seawater and the vitamin dosage is 1/2 ml per liter of seawater. Strong aeration is provided through an airstone. The 2,800-ml flask is placed 50 cm in front of four 40 watt, cool white fluorescent bulbs. In approximately four days, it is ready to be used as an inoculum for a 20-liter carboy. Eighteen liters of sterilized, boiled, 1 micron-filtered seawater and Guillard's F/2 medium are added to the carboy at the time of the inoculation. Lighting and moderate aeration are provided. The bloom occurs in the carboy in approximately two to three days and is used to inoculate other carboys. The blooms from six carboys are used to inoculate the larval-rearing tank. Silicate is omitted when the rearing tank is fertilized.

Growth Characteristics

Given the right conditions (nutrients, light, temperature, etc.) algal cultures will generally exhibit the growth pattern shown in Figure 43b.

The object is to keep the culture in the exponential phase or phase of rapid cell division. The best way to do this is to dilute out the culture constantly with new media or better still, move the existing culture into a larger, clean vessel with new media. Algal growth dynamics are covered in great detail in a paper by J.M. Fox on Intensive Algae Culture in CRC Manual, 1983.

Culture Techniques

Stock cultures, obtained from another hatchery, a government aquaculture research facility or other culture supplier such as The University of Texas Department of Botany and others listed in *Aquaculture Magazine Buyer's Guide*, are used as starter cultures. Stock cultures can be maintained in small screw-cap test tubes, with the tops left loose (see Figure 47). The algae can be kept in a dormant stage by diluting out the nutrient medium to F/8 (which is Guillard's F medium, diluted four times more than the standard F/2 medium) and maintaining the algae at 24°C in low light. These conditions will restrict growth to a maintenance level and there will not be a build-up of metabolic wastes. You should not handle stock cultures

except when transferring on a monthly basis. It is best to keep them in a separate room and transfer small amounts, under sterile or aseptic conditions, to a new enriched medium tube every other week or on a monthly basis depending on the preferred schedule. Figure 47 depicts a typical algal transfer routine and production-line schedule.

Small flasks (Photo 57) are inoculated from the tubes and held in a high light area. Once the cultures in the flasks are a few days old and their respective cell counts have increased considerably, they can be transferred first to large flasks and, after a similar waiting period, to a 19-liter carboy (Figure 48). The objective is to keep the algal species the dominant species in the culture. This is done by adding a pure inoculum culture to a relatively clean and sterilized seawater growth medium. Carboys are then placed on an algae rack (Figure 49) or arranged similarly to the ones in (Photos 58, 59 and 60), which are photographs of a typical algae room.

Filtration, Sterilization, Disinfection

Seawater is filtered down to one micron and disinfected, sterilized or treated before it is used in algae culture. The amount of filtration required is largely dependent on characteristics of the incoming seawater. Therefore, the amount of filtration is largely site-specific. In some areas, extensive filtration is required and in others, only minimal steps are required to clean up the water. According to Wheaton (1987) sterilization is the total destruction of all living organisms, but disinfection is the destruction of all or nearly all organisms harmful to the user of that water. Only disinfection may be necessary and will be cheaper than sterilization.

The requirement for or level of sterilization is also site-specific to some extent. Standard sterilization conditions are described as 121 °C and 20 psi, with sterilization time dependent upon the volume of water being treated (15 minutes for liquids less than one liter, 45 minutes for larger volumes such as a 19-liter carboy).

Sterilization (or disinfection) as the treatment of seawater before being used in the algae room can be accomplished using heat, ultraviolet (UV) radiation and/or chemicals.

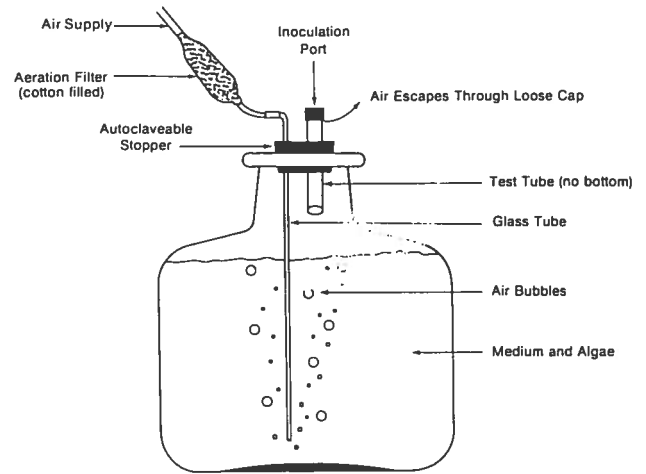

Figure 48. Glass Carboy

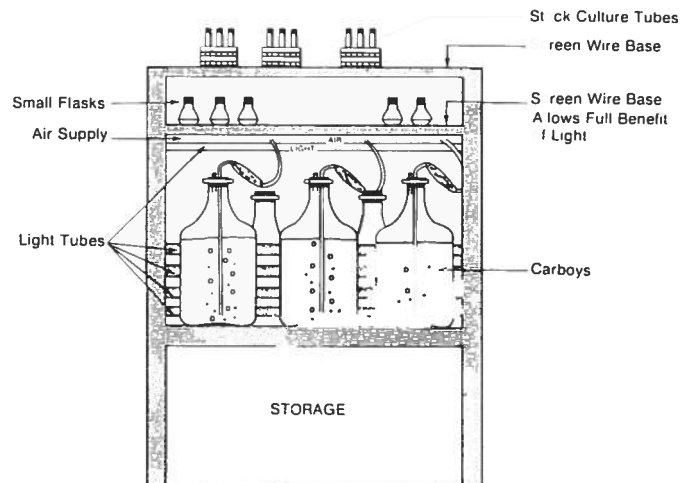

Figure 49. Typical Algae Culture Rack

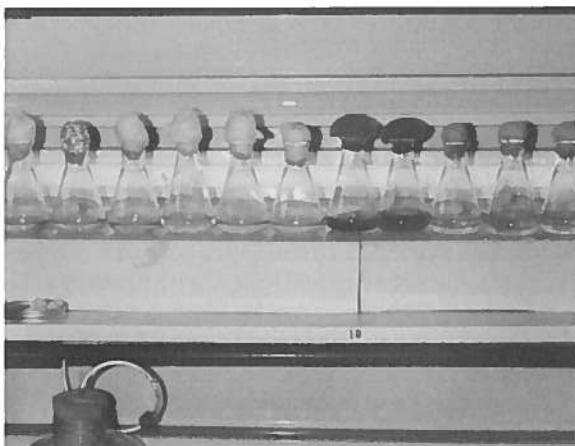
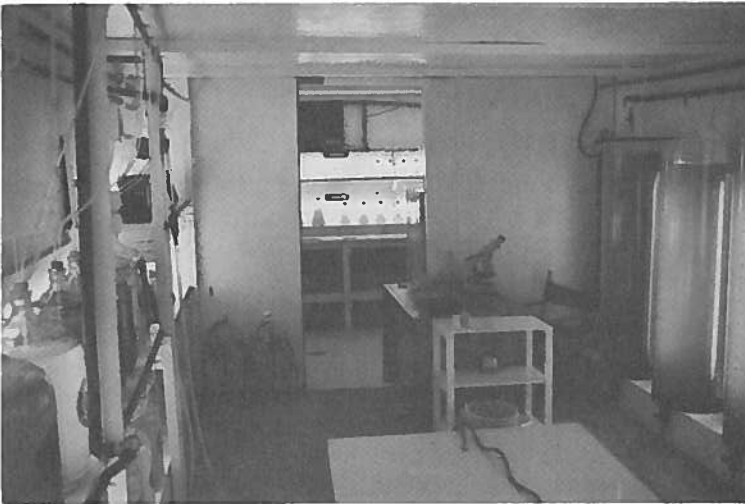
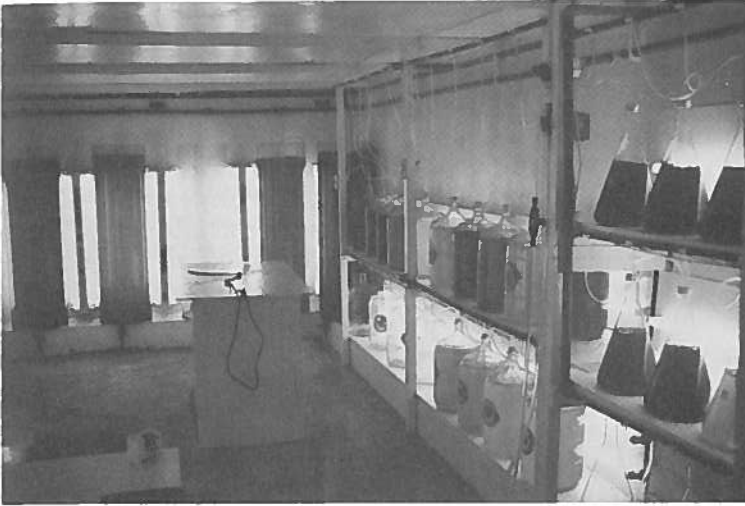

Photo 57. Algae production in small flasks.



Photo 58. Algae production in glass jars (wide mouth allows easy access for cleaning jar).



Photos 59 and 60. Typical algae room arrangement.

1. **Autoclaving**—This system is the most effective and the most preferred, but is also very expensive. The glassware will last longer using this method, compared to direct heating methods. Carboy size autoclaves cost approximately \$3,000, and the smaller, pressure cooker size autoclave, for sterilizing tubes and small flasks, costs approximately \$300. This method is most often used in research labs, and is not widely used by commercial operations where a more cost effective method must be used. Autoclaves can be either electrically powered or gas fired, but the energy requirement is the primary disadvantage for this process.
2. **Chlorination**—Bleach, with a 5.25 percent activity, 2.5-ppm solution in seawater has been found to be an effective treatment method. The treated seawater is left for 24 hours and then aeration is added to remove remaining chlorine or at least neutralize its effects. The use of sodium thiosulfate has been used by some hatcheries to neutralize the chlorine, but with the delicate trace metal balance found in seawater, it comes as no surprise to find out that the addition of this chemical has caused side-effects of its own at some of these hatcheries.

3. **Pasteurization**—Heating water can effectively sterilize or disinfect if it is heated to a sufficiently high temperature and held at this temperature for a certain time interval. Bacterial kill is a function of temperature and time as well as the species targeted for elimination. For example, pasteurization of milk is recommended at 60°C for 30 minutes or 71.1°C for 15 seconds. The hatchery manager may adjust the extent of kill necessary for his or her site by varying the temperature and/or holding time at the elevated temperature. For most areas, the authors have found that the following steps are necessary for pasteurization of seawater to be used in the algae room:

Heat a carboy or other container of seawater to 73°C and hold 5 minutes (media included), then let it cool overnight. The following day reheat the enriched seawater to 73°C and let it cool as before. The media is then ready to inoculate. The idea is to eliminate any contaminants that may have been forced into a spore stage as a result of the first heat treatment while not heating the water high enough to cause the trace metals in the seawater and enrichment media to precipitate out as they do when autoclaved. Heating can be done with an immersion heater or with some type of flame or other heat source. This is a time-consuming method of sterilizing and contaminants seem to appear much sooner than when using the autoclave to sterilize, but again, the primary disadvantage of using heat for disinfecting water is the energy requirement of the process.

Note: Microwave ovens may also be used to pasteurize sea water in tubes and small flasks. (See Keller et al., 1988 for details).

4. **Ultraviolet Treatment Design Summary (Wheaton, 1987)**—The design of an ultraviolet (UV) treatment system is summarized as follows:

- Determine dosage of UV radiation necessary to kill the target organisms.
 - Adjust dosage for water turbidity. It is easier and more cost efficient to eliminate turbidity than to purchase more equipment (i.e. higher dosage).
 - Determine flow rate needed.
 - Using lamp intensity data from the manufacturer and the reflector characteristics for suspended systems determine the following:
 - Water depth needed to get 90 percent or greater UV absorption.
 - Number (and spacing for a suspended system) and type of UV lamps to be used to provide required dosage to treat required flow rate.
- Locate baffles to achieve required turbulence and water depth to get 90 percent UV absorption. (To minimize absorption by baffles, the devices are best placed parallel to the lamp axis. However, turbulent flow requirements may dictate other baffle designs.)
5. **Ozone as a Disinfectant (Summarized from Wheaton, 1987)**—Ozone is a triatomic form of oxygen that is a bluish gas of pungent odor, is naturally in the upper atmosphere (although apparently in less and less quantities these days) and is formed by a photochemi-

cal reaction with solar ultraviolet radiation. According to Wheaton (1987) ozone has been recognized as a "purifying agent" since 1782; the first commercial use of ozone was in 1906.

Ozone is formed when oxygen molecules are excited to decompose into atomic oxygen. Collisions of these atomic oxygen atoms cause the formation of ozone. Nearly all commercial ozone generators use a high voltage corona discharge system described by Wheaton (1987, p. 633).

The effectiveness of ozone as a disinfectant is a function (as is UV radiation treatment) of contact time and dosage. Ozone reacts very quickly compared to compounds such as chlorine because ozone is toxic on contact whereas chlorine acquires toxicity. Compared to chlorine, ozone is twice as powerful as an oxidant. Pavoni *et al.*, (1975) and Nebel *et al.*, (1975) demonstrated that ozone reduced both bacterial and viral organisms very rapidly. Many other investigators have shown similar results (e.g. Kelly, 1974).

Organic matter exhibits an ozone demand. In fact, ozone is used for removal of color, odor and turbidity in some municipal water systems. Inorganic chemicals in the water also exhibit an ozone demand (i.e. iron and magnesium can be oxidized to the insoluble oxide forms by ozone).

Ozone is directly toxic to aquatic organisms and to people. Ozone is fatal to people when they are exposed to 11,000 ppm by volume for 0.1 minute or about 20 ppm by volume for 1,000 minutes. Toxicity starts to occur for people at exposures of 3,000 ppm by volume for 0.1 minute or 4 ppm for 1,000 minutes (Nebel *et al.*, 1975). Toxicity data for aquatic organisms is not available except as very scattered individual points that cannot be put into a meaningful picture. For example, Arthur and Mount (1975) found that 0.2 to 0.3 ppm ozone is lethal to fathead minnows. Luckily, ozone is quite unstable and rapidly decomposes to molecular oxygen. Providing a few minutes between ozone treatment and introduction of the ozonated water into a culture system may be sufficient to avoid problems.

Design of ozone water-treatment systems requires the establishment of intimate contact between the target organisms and the ozone gas. The mixing of the ozone and water is of primary importance.

Selection of the appropriate contacting system depends on the application, flow rates and other parameters of a specific design. The objective is to provide as much contact between target organisms and ozone as possible. This means having the largest possible exchange surface between gas and liquid. The appropriate contact time must also be maintained to achieve disinfection. When pure oxygen is used in the ozonator, it usually is economically attractive to recycle the oxygen given off in the contactor.

The necessary contact and concentration vary with target organisms and water quality. However for municipal sewage it appears that residual ozone concentrations at the contactor outlet of 0.5 mg/liter and a 5- to 10-minute contact time give 99 percent or better

disinfection. In most cases, aquacultural systems are able to reduce these values because incoming water is of better quality. The organic content and inorganic chemical ozone demand should be lower for aquacultural waters than for full strength sewage. Blogoslawski *et al.* (1975) found undetectable bacterial survival in seawater at 0.56 mg/liter ozone concentration when using the water in an aquacultural laboratory. Contact time was not specified. Based on kill time of various bacteria and virus species reported in literature (Katzenelson and Shuval, 1975; Kelly, 1974; Smith and Bodkin, 1944; Sproul and Majumdar, 1975), it would appear that 1- to 5-minute contact time and a dosage of 0.56 to 1.0 mg/liter are reasonable values for ozone treatment of most aquaculture systems. However, on-site tests are the only positive methods for determining required ozone concentrations and contact times. It should also be noted that measuring ozone concentration is not an exact science in that different measurement systems give different concentrations in the same sample.

A Commercial Application of Ozone

From commercial experience in Ecuador (1990 to 1991), Maria Gonzales (personal communication, 1992) achieved an increment in production from 20 million to 40 million postlarvae per month using ozone as a disinfectant. She reported the following advantages with ozone: decrease in overall bacterial levels; almost no application of chemicals and antibiotics; achieved postlarval 10 production in 17 days from the beginning of cultivation, which normally took 20 to 22 days without ozone; animals were larger and more active than those cultivated by usual means; and reduced bacterial levels in *Artemia* washed with ozone water.

The ozone system offers great advantages, but it can also be very dangerous if correct levels are not used. Figure 50 shows the recommended amount of ozone that should be used for each shrimp larval stage and for algae and *Artemia* cysts disinfection, and gives the formula for checking the ozone residual in seawater.

Figure 50. Recommended Ozone Levels and Formula for Checking Ozone Residual

Organism	Amount of Ozone Recommended (mg/L seawater)
Algae	0 (ozone kills algae, use carbon filtration)
Nauplius	0
Zoea I-Zoea III	0.06
Mysis I	0.07
Mysis II-Mysis III	0.08
Postlarvae	0.09
<i>Artemia</i>	0.5

Note: There should be no more than 50 meters distance between the ozone contact tower and the reservoir or no more than 50 meters from the reservoir to the larval tanks so these ozone levels can be maintained in the piping system.

Procedure to Determine Residual Ozone in Seawater and Formula to Calculate It

Procedure:

Step 1. Two solutions must be prepared. To prepare solutions:

Solution A: Mix 20 grams Iodine potassium (IK) per liter distilled water.

Solution B: Standard Solution sodium thio sulfate = $\text{Na}_2\text{S}_2\text{O}_3 \times 5\text{H}_2\text{O}$. (A constant of 0.025 is used in the formula in addition to added amount).

Step 2. Add equal amounts of Solution A (IK at 20g/liter dist. H₂O) and

water sample to be tested for ozone residual. Example: 300ml Sol. A added to 300 mls of water sample.

Step 3. To the mixture made in Step 2 (equal amts. of IK and water sample) drop in Solution B ($\text{Na}_2\text{S}_2\text{O}_3 \times 5\text{H}_2\text{O}$) until the mixture changes color. When the color changes, stop and see how many mls of Solution B it took to make the color change (this number of mls is substituted for A in the formula).

Step 4. Using the following formula calculate the residual ozone in mg/l.

Formula: $\frac{A \times 0.025 \times 24,000}{B} = \text{Residual ozone in sample (mg/l)}$

A = Amount mls. of Solution B to change color of sample

0.025 = constant assigned for sodium thio sulfate

24,000 = constant

B = Amount mls. in water sample to be tested (only water sample).

NOTE: Ozone can be hazardous to humans and must be used with extreme caution with the safety of the workers in mind!

Comparison of Disinfection Methods (Summarized from Wheaton, 1987)

Heat is effective as a disinfectant and does not leave harmful or toxic residue. However, it is so expensive however that it is not economically feasible under most circumstances.

Chlorine and two other halogens, bromine and iodine, are effective disinfectants. They work well on bacteria but require considerable contact time (20 to 30 minutes or more) for virus kill. Chlorine combines with organic materials to form chloramines. Both chloramines and chlorine gas are highly toxic to most aquatic organisms. Chlorine gas can be removed by aeration, but chloramines cannot be removed easily using this means.

Ozone is highly effective as a disinfectant, having about twice the oxidizing capabilities of chlorine. (The oxidation potential of chlorine is 1.65 E₀V, while ozone is 2.05 E₀V). Ozone kills both bacteria and virus with equal effectiveness and speed. Dosage and contact time are normally lower for ozone than for chlorine to produce equal results, yielding some capital investment savings for contact tanks. Ozone must be manufactured on site because it is too unstable to withstand shipping. Ozone is presently more expensive than chlorine. The major advantage of gaseous oxidant disinfection is the production of a residual that is hydraulically entrained. Thus, it travels

through the entire distribution system on a continuous cleaning basis.

Ultraviolet light is an effective disinfectant as long as turbidities are kept below reasonable limits. Moreover, UV does not produce residues in water and is simple to operate and install. Economic methods for large-scale use are not presently available. In laboratory and aquacultural operations, UV systems probably constitute the best disinfection method available. They can be purchased from several manufacturers. Maintenance of these units can be cumbersome (the quartz sleeves must be cleaned periodically and are very breakable. The half-life of the bulbs is measured in weeks instead of months. Periodic bulb replacement is a continuing expense, as is electricity. However, these units must be compared with the price of the chemical when using chlorine, or electrical requirements for ozone production.

Other Disinfection Methods

Centrifugation Washing, Antibiotics or other Chemicals

Filtration and disinfection or sterilization techniques are site-specific and the specific method used at one facility may not be suitable at another. One of these three methods (heat, ultraviolet radiation or chemicals) or a combination of these should meet the needs of most hatcheries. Contamination of algae cultures is going to happen eventually no matter which method is used, but the operator must experiment and find which method works best for the location, budget constraints, etc., and be prepared to restart the culture routine from scratch if a contamination does occur somewhere in the assembly-line. New stock cultures should be initiated as a matter of typical management.

Counting Algal Cells and Determining Amount to Feed Larvae

- A. To determine the number of cells per ml of sample, do the following:
 1. Count number of cells per 1/10 cubic mm in hemacytometer chamber (i.e. the number of cells in 1 square mm in hemacytometer chamber).
 2. Multiply this number by 10,000 (See Figure 51, depicting the hemacytometer parts).
 3. See "Preparation of Sample and Hemacytometer" and "The Use of the Hemacytometer."
- B. To determine the number of cells to be added to larval-rearing tank (LRT) in ml:
 1. Total number of cells required in LRT = Volume of LRT, in ml OR x number of cells required per ml.
 2. Number of cells at present, per ml.
 3. Number of cells to be added to LRT = Total number of cells required in LRT - number of cells at present in LRT.

$$= (\text{Vol. of LRT, in ml} \times \text{no. of cells req'd, per ml}) - (\text{Vol. of LRT, in ml} \times \text{no. of cells at present})$$

$$= (\text{Vol. of LRT, in ml}) \times (\text{No. of cells req'd} - \text{no. of cells at present})$$
- C. To determine volume of algal culture to LRT:

1. Volume to be added, in ml x no. of cells per ml in algal culture tank = no. of cells to be added to LRT.

THEREFORE:

Volume to be added, in ml = no. of cells to be added to LRT

Alternate Explanation of Algae Cell Counting and Determining Amount of Feed

A. How to count algae (Refer to Aquaculture Extension Manual No. 9, Southeast Asian Fisheries Development Center).

B. Determining amount of feed:

The amount of algal food to be fed to the larvae is computed as follows:

Without previous feeding in larval-rearing tank (LRT) —

$$\text{Vol. of algae to be added} = \frac{\text{Vol. of water in LRT} \times \text{Desired algal density in LRT}}{\text{Algal Density in Culture Tank}}$$

EXAMPLE:

$$3,000 \text{ l} \times 5,000 \text{ cells algae/ml}$$

$$\text{Vol. of algae} = \frac{1,000,000 \text{ cells algae/ml}}{= 15 \text{ liters}}$$

With previous feeding in larval-rearing tank (LRT) —

$$\text{Vol. of algae to be added} = \frac{\text{Vol. of water in LRT} \times \text{Desired algal density in LRT} - \text{Algal density in LRT}}{\text{Algal density in culture tank}}$$

Example:

$$\text{Vol. of algae to be added} = \frac{3,000 \text{ l} \times (2,500 \text{ cells/ml} - 1,000 \text{ cells/ml})}{\text{Algal density in culture tank}} = 15 \text{ liters}$$

The Use of the Hemacytometer

(Note: Not all hemacytometers are the same. Only one variety is described here.) The authors prefer the "New Improved Neubauer" hemacytometer because there is a depression on the bottom of the hemacytometer in the corresponding area of the counting chamber that helps keep scratches from occurring on the glass. These scratches can eventually cause confusion to the operator when the scratches appear similar to the scores on the upper side of the counting chamber. The authors also find that the scores are easier to see on the "New Improved Neubauer."

The hemacytometer (Figure 51) consists of two parts. The major element is formed from a slab of thermal and shock-resistant glass. An H-shaped trough has been cut into this, forming two raised counting areas. Raised shoulders on either side of the H are precision-milled to exactly 0.1 mm above the counting area. The cover glass, a 0.4-mm, highly polished piece of glass, rests on the shoulders, forming the top of the counting chamber.

The counting areas are covered with a thin, metallic film that gives them a slightly darkened appearance under the microscope. Lines are scribed into this film with great precision (see Figure 51). The "tic-tac-toe" pattern has nine squares, each 1 mm by 1 mm. These are divided into 25 smaller squares, and the center square is further subdivided

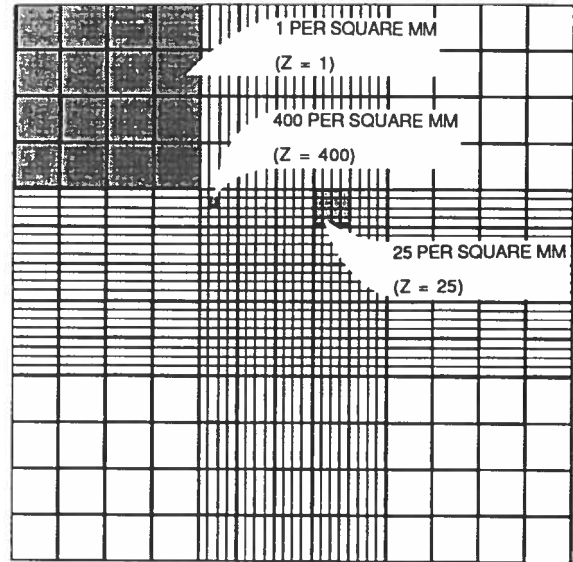

MAGNIFICATION OF COUNTING AREA

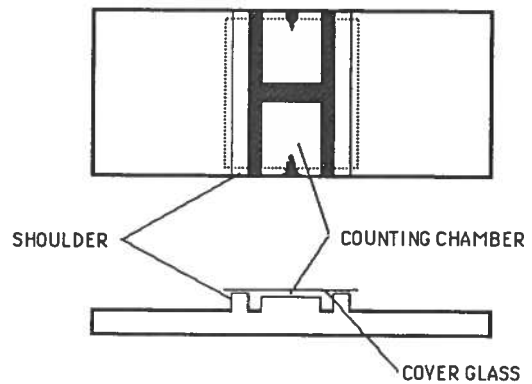

Figure 51. Hemacytometer

vided into 400, 0.05-mm squares. The dimensions of the cover glass are very important to achieving replication in counts.

Preparation of Sample and Hemacytometer

1. Before starting, the hemacytometer and cover glass should be cleaned and dried. A piece of lens paper dampened with distilled water should be used.
2. A sample of algae is obtained from the algae culture tank or from the larval-rearing tank. This is placed in a clean test tube and, if necessary, 2 to 3 drops of Lugol's stain are added and the tube is shaken to kill and immobilize the cells.
3. The tube is agitated again to mix the cells in the medium thoroughly. A clean eyedropper or pipet is used to remove approximately 0.5 ml of the mixture.
4. A single drop is introduced to the V-groove on the side of the hemacytometer. This will be drawn under the cover glass, into the counting chamber, by capil-

lary action. Care should be taken to introduce just enough to fill the counting chamber. If the troughs are filled and shoulders wet, the cover glass will lift and the counting chamber will enlarge. Should this occur, the hemacytometer should be cleaned and the process started again.

5. The cells will take about a minute to settle. The hemacytometer is now placed on the stage of the compound microscope. Using the lowest power of magnification, the microscope is focused.
6. For accuracy, a minimum of 100 cells should be counted. Depending on the concentration of the cells, this might require counting the entire scribed counting area, counting just the four larger corner squares or counting all or some of the center square. This should be done systematically, counting the same blocks each time, thus eliminating bias.
7. The calculations should then be carried out as follows:
 - a. Count number of cells (X)
 - b. Divide (X) by the number of squares counted (Y)
 - c. Multiply that number by the number of squares per square mm (Z)
 - d. Multiply that number by 10,000 to obtain the number of cells in each ml of medium (N)
$$N = \frac{(X) \times (Z) \times 10,000}{(Y)}$$

How to Calculate Algae Culture Requirements Based on 60,000 Liter Larviculture Capacity

1. Assumptions
 - a. Desired algal species:
Chaetoceros gracilis (*neogracile*)
Tetraselmis chuii
These two species have proven themselves to be very reliable in terms of larval performance and ease of culture.
 - b. Projected maximum algal feeding densities for larval-rearing tanks (LRTs):
Chaetoceros: 120,000 cells/ml
Tetraselmis: 35,000 cells/ml
 - c. Expected cell densities in algae mass culture tanks at peak log-phase growth:
Chaetoceros: 3×10^6 cells/ml
Tetraselmis: 7×10^5 cells/ml
2. Maximum number of cells required for a complete one/day feeding of total larviculture volume computed as (maximum feeding density) \times (larviculture capacity):
Chaetoceros: $120,000 \text{ cells/ml} \times 6.0 \times 10^7 \text{ ml} = 7.2 \times 10^{12}$ cells
Tetraselmis: $35,000 \text{ cells/ml} \times 6.0 \times 10^7 \text{ ml} = 2.1 \times 10^{12}$ cells
3. Total volume of algae mass culture needed for maximum daily feeding at standard expected mass culture densities:
Chaetoceros: $\frac{7.2 \times 10^{12} \text{ cells total}}{3.0 \times 10^6 \text{ cells/ml in mass culture}} = 2,400,000 \text{ ml} = 2,400 \text{ liters/day}$
Tetraselmis: $\frac{2.1 \times 10^{12} \text{ cells total}}{7.0 \times 10^5 \text{ cells/ml in mass culture}} = 3,000,000 \text{ ml} = 3,000 \text{ liters/day}$

4. To maintain algal cultures at desired densities and log-phase growth (best nutritional value), it is advisable to harvest or cull about 50 percent of *Chaetoceros* and about 33 percent of *Tetraselmis* on a daily basis once the desired feeding densities have been reached. Thus, the total volume of each species being fed daily should represent 50 percent and 33 percent of the total volume of each species, respectively, that is available for feeding on that day. Thus, there should be the following:

Chaetoceros: $\frac{2,400 \text{ liters}}{0.50 \text{ (50 percent)}} = 4,800 \text{ liters of } \textit{Chaetoceros}$ available on a daily basis (round to 5,000 liters/day)

Tetraselmis: $\frac{3,000 \text{ liters}}{0.33 \text{ (33 percent)}} = 9,091 \text{ liters of } \textit{Tetraselmis}$ available on a daily basis (round to 10,000 liters/day)

5. Algae mass culture tank allocation:
 - a. One 5,000-liter tank of *Chaetoceros* and one 10,000-liter tank of *Tetraselmis* should be available at feeding densities on a daily basis.
 - b. Two additional identical mass culture tanks for each species should also be in production starting at five-day intervals behind the first pair.
6. Six 750-liter intermediate algal mass culture tanks to be used as the inoculate source for the mass culture tanks will be kept in a separate climate-controlled room. These will be run as three pairs (one tank per species) on a strict five-day crop and removal schedule, coinciding with an operating schedule of 5,000 and 10,000-liter algae mass culture tanks.
7. Intermediate algae mass culture tanks (750 liters) will be supported by appropriately scheduled flask and carboy or hanging bag cultures.
8. Two 5,000 liter reservoirs will store cooled seawater for use in the intermediate algae culture lab (21 to 23°C).

Alternate Larval Diets

Egg Diet Preparation for Penaeid Larvae (Mysis I or older)

1. With a grinding implement, grind up two tablets of vitamin B-12 and one tablet of vitamin C. Put contents into 100 ml plastic beaker.
2. Add 25 mls of brewer's yeast to 100 ml plastic beaker.
3. Set up blender without lid. Add 11 large raw eggs without shells.
4. Add contents from 100 ml beaker into blender and mix at high speed for 30 seconds. Stop blender.
5. Add 270 ml cod liver oil and start mixing again at high speed.
6. As soon as possible measure out 150 ml of white flour and add to blender.
7. Mix contents until all flour has been put into solution (about 30 seconds).
8. Add 80 ml of liquid lecithin and mix for 1 1/2 minutes. **Now it is ready to cook.**

Cooking Directions

1. Pour one third of the egg mixture into square glass container and put into microwave on high for two and one half minutes.
2. Repeat step one for remainder of the egg diet.
3. Put into plastic bags labeled Egg Diet and date.

Feeding Directions and Application Rates

1. Force egg diet through stainless steel mesh, 200-250 mm (60 mesh) or smaller.
2. Feed at least four times daily at even intervals by suspending the amount to be fed into an equal amount of water before feeding the slurry.
3. Feed is adjusted ad libitum to ensure that a build-up of uneaten feed does not occur.
4. Generally, for a 9,500-liter tank, stocked with 100 larvae per liter, 100 ml. of slurry (50 percent water by volume) is fed per feeding initially. The amount is adjusted daily.

Microencapsulated Diets

Microparticulate and microencapsulated diets have been used to provide chemically known compounds to decapod larvae (Jones *et al.*, 1979; Villegas and Kanazawa, 1980; Kanazawa *et al.*, 1982; Levine *et al.*, 1983; Teshima and Kanazawa, 1983; Levine and Sulkin, 1984; Scura *et al.*, 1985; Jones, 1985 and 1987). Among the most promising types of microcapsules are the calcium alginate microcapsules developed by Levine. Many companies now offer microencapsulated diets (such as FRIPPAC®, Alma, Ocean Star International, Inc., Zeigler Bros., Inc., Biokyowa, Inc., and Nippai Shrimp Feed, Inc.), each with varying results. They all remain quite expensive. Further refinements are required before these diets can be used in place of live foods on a commercial scale.

One refinement, reported by Dr. D.A. Jones at the 1987 World Aquaculture Society conference, was a new microcapsule with a thinner wall (designed to break down in the gut of zoea in only four minutes). This particular diet was being commercially manufactured by Frippak Feeds in England, (which was sold recently to a French group).

Personal experiences with these diets have shown them to be a good supplement to live food but unsatisfactory to use alone as a complete larval diet. Some of these diets have oils and create a "slimy" or "oil slick" surface and the water level in the tank must be lowered daily. The oils can then be wiped off the tank wall with a dry cloth before refilling the tank. Most of these diets contain fats and need to be frozen or kept refrigerated after the container is opened to keep the diet from becoming rancid. Realistically, bacterial contamination is probably the greatest threat in a larval-rearing tank. Adding live food to the tank helps cut down on this threat and helps keep the bacteria at manageable levels. When finely powdered diets (dead foods) are added, even though they are coated with a cross-linked nylon-protein wall to help stop nutrient leaching and contamination, there is still a high probability of bacterial contamination.

Omega Yeast

Both Japanese and Filipino researchers recognize the

potential use of single cell protein (such as brewer's yeast) as a larval shrimp feed substitute (Furukawa, *et al.*, 1973, and Aujero, *et al.*, 1985), but yeast products are typically deficient in essential long chain, highly-unsaturated fatty acids (HUFA). Yeast products, which have been artificially enriched with essential long chain, highly-unsaturated fatty acids (HUFA) of the omega 3(n3) family, have also been used to replace phytoplankton with varying degrees of success. Yeast has a tendency to adhere to the appendages of the larvae and cause problems similar to external bacteria and debris build-up on the larvae (interfering with swimming, feeding and metamorphosing). The addition of a chelating compound such as EDTA may help this problem.

Miscellaneous Sources Used as Feed

The following is a list of other sources used as feed for larval penaeid shrimp: Rotifers, *Mytilus* eggs, frozen *Artemia*, brine shrimp flakes, *Moina* sp., Copepoda, *Gammarus* sp., *Balanus* sp. Nematoda, Annelida, clam meat, shrimp meat, fish meat, milled feed, sprayed dried feed, and freeze-dried algae.

A wide variety of potential algal substitutes have been utilized including the ones listed above (boiled chicken egg yolk, microencapsulated diets, microparticulate diets, yeasts) in addition to fermented soybean cake, but each of these can only offer a minor component (less than 50 percent) of the diet of zoea because none has a nutrient composition equal to that of phytoplankton. Another substitute diet, called the "Crustacean Tissue Suspension," is used in India (Tacon, 1986).

Signs of Larval Stress, Diseases and Treatments at Dian Desa

Usually, the first sign of stress is debris collecting on the animal. If mortalities are seen then, larval samples should be taken and observed under the compound scope to determine the cause. It may be low food levels, bacteria, *Zoothamnium*, *Lagenidium*, or any number of other problems that need to be identified and treated. It is important to look at the larvae and postlarvae in each tank under the microscope everyday. More frequent examination may be required if there is a problem. The problems encountered during two runs of larvae at the Dian Desa Hatchery in July and August 1987 were as follows:

PROBLEMS	TREATMENTS
1. Empty guts	1. Feed more
2. Luminous bacteria	2. See Control of Luminous Bacteria in Disease section
3. <i>Zoothamnium</i>	3. Malachite Green (1 ppm)
4. <i>Lagenidium</i>	4. Treflan (5 ppm, 50ml/ton)

These were the main problems encountered. Low temperatures were a problem (25° C to 26° C) until heaters were temporarily placed in the tanks to offset the early morning temperature drop. The heaters were not needed during the afternoon.

More Detail of Treatments

Fungicide—Contamination of larvae by fungi (*Lagenidium* sp.) is frequent and a continuous preventive treatment is necessary. Treflan, diluted to 5 ppm solution, is distributed constantly at 50ml/ton.

Antibiotics—Antibiotic treatments are used to control bacterial contamination, which results in necrosis of the larvae and often numerous mortalities. Chloramphenicol has been found to be most effective and is used as a preventive with 2 to 6 ppm every two days or curatively with doses of 2 to 10 ppm.

EDTA—May also be needed at 2 ppm as a chelator (if some debris appears on larvae or particles seem to be adhering to the larvae's setae or appendages). EDTA increases the availability of trace metals, and a 2 ppm solution in the LRTs assists the larvae metamorphose on to the next stage if they appear to be having a problem.

Harvesting Larval-Rearing Tanks at Dian Desa

When larvae staging shows that 100 percent of the tank's contents are in the PL stage, and three to four days have passed (larvae are at PL3 or PL4), then the LRT is gravity drained into the PL raceway below. The *Artemia* and algae from the LRT act as a food source, but are diluted out when transferred to the 20,000-liter, maximum-capacity raceway (which is usually only half full at stocking time). Therefore, additional *Artemia* must be added as soon as the PLs are transferred. Fast siphoning PLs into a small bucket for transfer to the raceway should be avoided. This may act to clean up the water, but will cause a 50-percent loss of animals due to handling. A gravity drain or a slow siphon directly to the raceways below appears to be the best method. Another method is to flush out the LRT with a continuous flow prior to harvest or siphon from the top down.

Extreme care should be taken to see that conditions in the raceway are as close to those in the LRT as possible (temperature, pH, etc.) before transfer begins. Example: Raceway water temperature on August 3 (0700 hours) was 25.9° C and LRT water temperature was 28° C. Flushing the raceway to bring the temperature up was not possible because the inflow temperature was 24° C, so transfer was postponed until the afternoon. At 1200 hours, the inflow water temperature was 28° C and the raceway was at 26.9° C. A rapid flow was given to bring the temperature up. A flow-through was also initiated in the larval-rearing tank to acclimate the PL4s to pH (7.9 in LRT and 8.2 in the inflow or raceway).

These steps must be taken to minimize transfer loss. Keep records of everything that is done so that when a problem develops a solution can be found or an answer can be discerned. Record temperatures, pH readings, feeding times and what was fed for each batch of larvae. Use the larval rearing data log (Figure 39) to keep these records. Place the data log on a clipboard near the tank with a thermometer and pencil nearby.

Selected References

Ozone

1. Arthur, J.W. and D.I. Mount, 1975. Toxicity of a disin-

fecting effluent to aquatic life. **International Ozone Institute, Waterburg, Conn. Symposium Proceedings**, pp. 778-786.

2. Blogoslawski, W.J., C. Brown, E.W. Rhodes, and M. Broadhurst, 1975. Ozone disinfection of a seawater supply system. *In First International Symposium on Ozone in Water and Wastewater Treatment*. International Ozone Institute, Waterbury, Conn., pp. 674-687.
3. Harris, Weldon C. 1972. Ozone disinfection. **Journal of the American Water Works Association**. 64(3): 182-183.
4. Jones, J.R. Erichsen. 1964. **Fish and River Pollution**. Butterworths, London.
5. Kelly, C.B., 1974. The toxicity of chlorinated waste effluents to fish and considerations of alternative processes. **Virginia State Water Control Board**.
6. Kelly, C.B. 1965. Disinfection of seawater by ultraviolet radiation. Second Reproduction. Research Department, Salt Water Fisheries Division, Florida Board of Conservation, Tallahassee. 12 pp.
7. Kelly, C.B. 1961. Disinfection of seawater by ultraviolet radiation. **American Journal of Public Health**. 51(11): 1670-1680.
8. Kjos, D.J., R.R. Furgason, and L.L. Edwards. 1975. Ozone treatment of potable water to remove iron and manganese: preliminary pilot results and economic evaluation. *In First International Symposium on Ozone for Water and Wastewater Treatment*. International Ozone Institute, Waterbury, Conn., pp. 194-203.
9. Leiguarda, R.H., O.A. Peso and Z.R. Palazzola, 1949. Bactericidal action of ozone. Abstracted in **Water Pollution Abstracts** 22(12):268.
10. Nebel, C., P.C. Unangst, and R.D. Gottschling. 1975. Ozone disinfection of second effluents: laboratory studies. *In First International Symposium on Ozone for Water and Wastewater Treatment*. International Ozone Institute, Waterbury, Conn., pp. 383-400.
11. Pavoni, J.L., M.E. Tittlebaum, H.T. Spencer and M.R. Fleishman, 1975. Ozonation as a viral disinfection technique. **International Ozone Institute, Waterbury, Conn. Symposium Proceedings**, pp. 340-366.
12. Smith, W.W. and R.E. Bodkin, 1944. The influence of hydrogen ion concentration on bactericidal action of ozone and chlorine. **Jrnl. of Bacteriology** 47:445.
13. Sproul, O.J. and S.B. Majumbar, 1975. Virus inactivation with ozone in water, *In Symposium Proceedings, International Ozone Institute, Waterbury, Conn.* pp. 288-295.

Algae Culture

1. Enright, C. 1984. Determination of the relative value of phytoplankton for feeding the juvenile oyster, *Ostrea edulis*. Doctoral dissertation, Halifax, Canada.
2. Fox, J. 1983. Intensive algal culture techniques. **CRC Handbook of Mariculture**, Vol. I. CRC Press, Inc., Boca Raton, Fla. p. 15-42.
3. Griffith, G.W., M.A. Murphy and L.A. Ross, 1973. A mass culture method for *Tetraselmis* sp. **W.M.S.** 4:289-294.
4. Guillard, R.R.L. 1975. Culture of phytoplankton for feeding marine invertebrates. *In Culture of Marine Invertebrate Animals*. W.L. Smith and M.H., Chanley,

- ed. Plenum Press, N.Y. pp. 29-60.
5. Hamilton, R. 1979. Sterilization. **Handbook of Phycological Methods**. Cambridge Univ. Press, Cambridge, Mass.
 6. Keller, M.D., W.K. Bellews and R.L. Guillard, 1988. Microwave treatment for sterilization of phytoplankton culture media. *J. Expo. Mar. Biol. Ecol.* 117: 279-283.
 7. McLachlan, J. 1973. Growth media-marine. In **Handbook of Phycological Methods, Culture Methods and Growth Measurements**. J.R. Stein, ed. Cambridge University Press, London.
 8. Smith, L.L., J.M. Fox and G.D. Treece. 1992. Intensive algae culture techniques. CRC Handbook of Mariculture CRC Press, Inc., Boca Raton, FL
 9. Simon, C.M. 1978. The culture of the diatom *Chaetoceros gracilis* and its use as a food for penaeid protozoel larvae. In **Aquaculture** 14:105.
 10. Starr, R.C., 1978. The culture collection of algae at the University of Texas at Austin. **Journal of Phycology** Vol. 14, Dec. 1978 (plus supplement, additions to UTEX Collection since 1978, dated 1985).
 11. Stein, J.R. 1973. **Handbook of Phycological Methods, Culture Methods and Growth Measurement**. Cambridge Univ. Press, London.
 12. Wheaton, F.W., 1987. Aquaculture engineering. Robert Krieger Pub. Co., Malabar, Fla. 708 pp.
- ### Larval Rearing
1. Al-Haji, A.B., C.M. James, S. Al-Ablani, and A.S.D. Farmer, 1985. Advances in hatchery production of *P. semisulcatus*, Kuwait Institute Sci. Research, **Bull. of Mar. Sc.** (6): 143-154. (English Abstract).
 2. Amjad, S. and D.A. Jones, 1989. A comparison of feeds used in penaeid larval culture. Presented at 1989 WAS Conference in Los Angeles, CA. USA.
 3. Aquacop. 1977. Larval rearing of penaeids in a tropical environment. *Actes de Colloques du CNEXO*, 4:179-191 (in French with English abstract).
 4. Aranyakananda, P. 1985. Larviculture of native white shrimp, *P. setiferus* and exotic white shrimp, *P. vannamei*, at Continental Fisheries, Ltd., Panama City, Florida (An internship report submitted to the Department of Wildlife and Fisheries Sciences, Texas A&M University.)
 5. Aujero, J., Tech. E., and Javellana, S. 1985. Nutritional value of marine yeast fed to larvae of *P. monodon* in combination with algae. In **Proc. of First International Conf. on the Culture of Penaeid Prawns/Shrimps**. Taki, Primavera, and Llobrera (Eds.). SEAFDEC; Philippines.
 6. Besbes, R. and J. Guillaume, 1989. Effect of protein level and iron supplementation on the growth and survival of *P. japonicus* larvae fed microbound diets. Presented at 1989 WAS Conference in Los Angeles, CA, USA.
 7. Biedenbach, J.M., L.L. Smith, T.K. Thomsen, and A.L. Lawrence, 1989a. Use of the nematode *Panagrellus redivivus* as an *Artemia* replacement in a larval penaeid diet. **Journal WAS** 20(2):61-71.
 8. Biedenbach, J.M., L.L. Smith, and A.L. Lawrence, 1989b. (manuscript in review). Preliminary findings on the use of a new spray-dried algal product in penaeid larviculture. Texas A&M University, Agricultural Experiment Station, P.O. Box Q, Port Aransas, TX 78373.
 9. Biedenbach, J.M., L.L. Smith, T.K. Thomsen, and A.L. Lawrence, 1987. Optimal level of the nematode *Panagrellus redivivus*, in the larval penaeid diet. **Journal WAS** 18:13A. **Aquaculture Communiques** #41.
 10. Chamberlain, G. 1988. Coastal Aquaculture Newsletter. Vol. V, No. 2, page 9, and Vol. V, No. 1 Jan. 1988; entitled "Shrimp Hatcheries."
 11. Chen, J.C., P.C. Liu, and Y.T. Lin, 1989 (manuscript in review, **Journal WAS**), "Larviculture of *P. monodon* in a recirculation and a semi-static system." Dept. of Aquaculture Nat. Taiwan College of Marine Science and Tech. Kellung, Taiwan 20224, Rep. of China.
 12. Chen, J.C. and T.S. Chin, 1988a. Acute toxicity of nitrite to tiger prawn, *P. monodon*, larvae. **Aquaculture**, 69:253-262.
 13. Chen, J.C. and T.S. Chin, 1988b. Joint action of ammonia and nitrite on tiger prawn *P. monodon* postlarvae. **Journal. WAS** 19(3):143-148.
 14. Chen, J.C., T.C. Chin, and C.K. Lee, 1986. Effects of ammonia and nitrite on larval development of shrimp (*P. monodon*). pages 657-662 in Maclean, Dizon and Hosillos, ed. The first Asian fisheries forum. **The Asian Fisheries Society**, Manila, Philippines.
 15. Chin, T.S. and J.C. Chen, 1987. Acute toxicity of ammonia to larvae of the tiger prawn, *P. monodon*. **Aquaculture**, 66:247-253.
 16. Cook, H.L. and M.A. Murphy, 1971. Early developmental stages of the brown shrimp, *P. aztecus* (Ives), reared in the laboratory. **Fishery Bull.** 69(1):223-239.
 17. Cook, H.L. and A.M. Murphy, 1969. The culture of larval penaeid shrimp, **Trans. Am. Fish. Soc.**, 98(4): 751-754..
 18. Cook, H.L. 1969. A method for rearing penaeid shrimp larvae for experimental studies. **FAO Fish Rep.**, (57)3: 709.
 19. Cook, H.L. and M.A. Murphy. 1966. Rearing penaeid shrimp from eggs to postlarvae. **Proc. Conf. S.E. Assoc. Game Comm.** 19, 384.
 20. Dobkin, S. 1961. Early developmental stages of pink shrimp, *P. duorarum*, from Florida waters. **Fish. Bull.**, 61(190):321-349.
 21. Emmerson, W.D. and B. Andrews, 1981. The effect of stocking density on the growth, development and survival of *P. indicus* larvae, **Aqua**. 23:45-47.
 22. Emmerson, W.D., 1980. Ingestion, growth and development of *P. indicus* larvae as a function of *Thalassiosira weissflogii* cell concentration. **Mar. Bio.** 58:65-73.
 23. Ewald, J.J. 1965. The laboratory rearing of pink shrimp, *P. duorarum*. **Bull. Mar. Sc. Gulf Caribb.**, 15(2):436-449.
 24. Furukawa, I., K. Hidaka, and K. Hirano, 1973. Production of larvae of *P. japonicus* with marine yeast. **Bull. Fac. Agr. Miyazaki Univ.**, 20(1):93-110.
 25. Fontaine, C.T., D.B. Revera, H.M. Morales, and C.R. Mock, 1981. Preliminary observations and procedures for the mass culture of the nematode *Panagrellus redivivus* for use as food stuff in penaeid shrimp hatcheries. Spec. Publ. Galveston Lab. NMFS, NOAA, Galveston, TX.
 26. Fontaine, C.T. and D.B. Revera, 1980. The mass culture of the rotifer, *Brachionus plicatilis*, for use as food stuff in aquaculture. **Proc. WMS** 11:211-218.

27. Fielder, D.R., J.G. Greenwood, and J.C. Ryall, 1975. Larval development of the tiger prawn, *P. esculentus* (Haswell), reared in the lab. *Aust. J. Mar. Freshwat. Res.*, 26:155-175.
28. Gabasa, P. 1981. Recent developments in design and management of a small-scale hatchery for *P. monodon* in the Philippines. FAO/UNDPSCSP Working Party on small-scale shrimp hatcheries in S.E. Asia.
29. Gabasa, P. and F. Sunaz, 1981. Design and construction of a low-cost hatchery system. Paper submitted to SEAFDEC, Philippines.
30. Gopalakrishnan, K. 1976. Larval rearing of red shrimp *P. marginatus*. *Aqua.*, 9:145-154.
31. Hameed, A.K., S.N. Dwivedi, and K.H. Alikunki, 1982. A new hatchery system for commercial rearing of penaeid prawn larvae. *Bull. Central Inst. Fish. Education, Bombay*, 2-3:9.
32. Heinen, J.M. 1976. An introduction to culture methods for larval and postlarval penaeid shrimp. *Proc. WMS*, 7:333-343.
33. Hirata, H., Y. Mori, and M. Watanabe, 1975. Rearing of prawn larvae, *P. japonicus*, fed soy-cake particles and diatoms. *Mar. Bio.*, 29:9-13.
34. Hudinaga, M. and J. Kittaka, 1967. The large scale production of the young kuruma prawn, *P. japonicus* (Bate). *Bull. Plankt. Soc. Japan*. 35-67.
35. Hudinaga, M. 1942. Reproduction, development and rearing of *P. japonicus*. *Nat. Res. Council of Japan, Tokyo.*, 10(2):305-393.
36. Hudinaga, M. 1935. Studies on the development of *P. japonicus* (Bate). *Rep. Hayatomo Fish. INST.* 1(1):1-51.
37. Imamura, S. and T. Sugita, 1972. Penaeid shrimp seedling mass production technology development studies: early rearing of larvae using artificial organic suspended matter. *Culture Tech. Res.* 1(2):35-46. (in Japanese).
38. Jones, D.A., K. Kurmaly, and A. Arshard, 1987. Feeding and assimilation of artificial feeds by crustacean larvae. *Journal WAS* 18(1):17A. *Aquaculture Communiques* #58.
39. Jones, D.A., 1985. Penaeid larval culture using microencapsulated diets. (Abstract) *First Inter. Conf. on the Culture of Penaeid Prawns/Shrimps*. Published by SEAFDEC, Iloilo, Philippines. Oct. 1985.
40. Jones, D.A., A. Kanazawa, and K. Ono, 1979. Studies on the nutritional requirements of the larval stages of *P. japonicus* (Bate) using microencapsulated diets. *Mar. Biol.*, 54:261-267.
41. Kanazawa, A., S. Teshima, H. Sasada, and S.A. Rahman, 1982. Culture of prawn larvae with micro-particle diets. *Bull. of Jap. Soc. of Sci. Fish.* 48:195-199.
42. Kuban, F.D., J.S. Wilkenfeld, and A.L. Lawrence, 1985. Survival, metamorphosis and growth of four larval penaeid shrimp species fed six food combinations. *Aqua.* 47:151-162.
43. Kungvankij, P., 1982. The design and operation of shrimp hatcheries in Thailand. *In Working party on small-scale shrimp/prawn hatcheries in South East Asia, Semarang, Central Java, Indonesia, 16-21 Nov. 1981. II Tech. Report, SCSFD & C.P., Manila, Philippines, May 1982.*
44. Kureha, N. and T. Nakenishi, 1972. On the *P. japonicus* seedling production in 2800-ton tanks. *Culture Tech. Res.*, 1(1):41-46 (in Japanese).
45. Leger, P. and P. Sorgeloos, 1987. Improved hatchery production of postlarval *P. vannamei* through application on innovative feeding strategies with an algae substitute and enriched *Artemia*. *Journal WAS* 18(1):17A. *Aquaculture Communiques* #56.
46. Leger, P. 1986. The use and nutritional value of *Artemia* as a food source. *Oceanogr. Mar. Biol. Ann. Report*. Vol. 24, pp. 521-623. Aberdeen Univ. Press.
47. LeMoullac, G.R. Leguedes, G. Cuzon, and J. Goguenheim, 1987. Micro-particulate diets for penaeid shrimp larvae. *Journal WAS* 18(1):18A, *Aquaculture Communiques* #61.
48. Levine, D.M., S.D. Sulkin, 1984. Ingestion and assimilation of microencapsulated diets by brachyuran crab larvae. *Marine Biology Letters* 5:147-154.
49. Levine, D.M. S.D. Dulkin, and L. Van Heukelem, 1983. The design and development of microencapsulated diets for the study of nutritional requirements of brachyuran crab larvae. Pages 193-203 in C.J. Berg Jr. (ed.), *Culture of Marine Invertebrates*. Hutchinson Ross Publishing Company, Stroudsburg, Pennsylvania.
50. Liao, I.C., 1988. Feasibility study for alternate culture species in Taiwan-*P. penicillatus*. WAS meeting Jan. 1988. Honolulu, Hawaii.
51. Liao, I. 1984. A brief review of the larval rearing techniques of penaeid prawns. *In Proc. of First Inter. Conf. on the culture of penaeid prawns/shrimps*. Pub. by SEAFDEC. 1985, pages 65-78.
52. Liao, I.C., editor, 1977. Manual on propagation and cultivation of grass prawn, *P. monodon*. *Tungkang Mar. Lab., Taiwan*.
53. Liao, I.C. and T.L. Huang, 1972. Experiments on the propagation and culture of prawns in Taiwan. Pages 328-354 V.R. Pilag (Ed.). *In Coastal Aquaculture in the Indo-Pacific Region*. Fishing News (Books) Ltd. 497 pp.
54. Liao, I.C., T.L. Huang, and K. Katsutani, 1969. A preliminary report on the artificial propagation of *P. monodon*. *J.C.R.R. Fish. Ser.*, 8: pages 67-71.
55. Maeda, Y., 1968. The seedling production of penaeid shrimp. *Fish Culture*, 5(2):64-70 (in Japanese).
56. McVey, J.P., 1983. *Handbook of Mariculture, Vol. I. Crustacean Aquaculture*, CRC Press Inc., Boca Raton, FL 442 pages.
57. Millamena, O. and E.J. Aujero, 1978. Preserved algae as food for *P. monodon* larvae. *SEAFDEC, Quarterly Report* 2:15-16.
58. Mock, C.R., D.B. Revera, and C.T. Fontaine, 1980. The larval culture of *P. stylirostris* using modifications of the Galveston Lab. Technique. *Proc. of WAS* 11:102-117.
59. Mock, C.R. and M.A. Murphy, 1970. Techniques for raising penaeid shrimp from the egg to postlarvae. *Proc. World Maric. Soc.* 1:143-156.
60. Motoh, H. 1979. Larvae of decapod crustacea of the Philippines - III, Larval development of the giant tiger prawn, *P. monodon* reared in the lab. *Bull. Jap. Soc. Sci. Fish.*, 45(10):1201-1216.
61. Pinto, L.G. and J.J. Edward, 1974. Desarrollo larval del camaron blanco, *P. schmitti*. *Bol. Cent. Invest. Biol., Univ. Zulia*, (12):1-61.
62. Platon, R., 1978. Design, operation and economics of a small-scale hatchery for larval rearing of sugpo, *P.*

- monodon* (Fabricius). Extension Manual No. 1, SEAFDEC, Philippines. 30 pp.
63. Primavera, N.G. (ed.) 1985. Prawn hatchery design and operation. Aquaculture Extension Manual No. 9, Second Edition, SEAFDEC, Iloilo, Philippines.
 64. Rothlisberg, P.D., B.J. Hill, and D.J. Staples, (Eds.), 1985. Second Australian National Prawn Seminar. NPS2, Cleveland, Queensland, Australia.
 65. San Felici, J.M., F. Munoz, and M. Alcaraz, 1973. Techniques of artificial rearing of crustaceans. *Stud. Rev. GFCM*, (52):105-121.
 66. SEAFDEC Aquaculture Dept., 1981. Crustacean hatchery. Annual Rep., pp. 13-17.
 67. Shigueno, K., 1975. Shrimp culture in Japan. Assoc. for Int. Tech. Promotion, Tokyo, Japan, 153p.
 68. Shigueno, K., 1972. Problems of prawn culture in Japan. Overseas Tech. Coop. Agency Publ., 37p.
 69. Simon, C.M. 1981. Design and operation of a large-scale, commercial penaeid shrimp hatchery. *J. World Maricul. Soc.* 12(2): 322-334.
 70. Sindermann, C.J. (Ed.), 1987. NOAA Technical Report NMFS 47, Feb. 1987: entitled Reproduction, maturation and seed production of cultured species; Proc. of the 12th U.S.-Japan meeting on Aquaculture. Baton Rouge, LA, Oct. 1983.
 71. Skokita, S., 1970. A note on the development of eggs and larvae of *P. latisuleatus*. *Biol. Mag. Okinawa*, 6:34-36.
 72. Smith, L.L. J.M. Fox, G.D. Treece and J.P. McVey. 1992. Intensive larviculture techniques. CRC Handbook of Mariculture. CRC Press, Inc., Boca Raton, FL
 73. Sorgeloos, P. et al., 1986. Manual for the culture and use of brine shrimp *Artemia* in aquaculture. Prepared for the Belgian Administration for Development, and FAO; State Univ. of Ghent. (*Artemia* Reference Center).
 74. Sorgeloos, P., E. Bossuyt, P. Lavens, P. Leger, P. Yanhaecke, and D. Versichele, 1983. The use of brine shrimp *Artemia* in crustacean hatcheries and nurseries, pages 71-96 in J.P. McVey (Ed.), *CRC Handbook of Mariculture Vol. 1*. CRC Press, Inc., Boca Raton, Florida.
 75. Sorgeloos, P., 1979. The life history of the brine shrimp *Artemia*. In: Inter. Symposium on the Brine Shrimp *Artemia*, Abstract and picture of *Artemia* egg and nauplii.
 76. Sudhakaro, R., 1978. Larval development of Indian penaeid prawns. In: Coastal Aquaculture: Marine Prawn Culture, CMFRI Bull. 28:60-64.
 77. Tabb, D.C., W.T. Yang, Y. Hirono, and J. Heinen, 1972. A manual for the culture of pink shrimp, *P. duorarum* from eggs to postlarvae suitable for stocking. *Sea Grant Spec. Bull. No. 7*, Univ. of Miami. 57 pages.
 78. Tacon, A.G.J., 1986. Larval shrimp feeding. Crustacean tissue suspension: A practical alternative for shrimp culture. Aquaculture Development and Coordination Programme, United Nations Development Programme, FAO Report ADCP/MR/86/23. Rome, Italy.
 79. Taki, Y., J.H. Primavera, and J.A. Llobrera, (Eds.) 1985. Nutritional value of marine yeast fed to larvae of *P. monodon* in combination with algae. In: Proceedings of the First Inter. Conf. on the Culture of Penaeid Prawns/Shrimp, Dec. 1984. Iloilo city, Philippines. p. 168.
 80. Tang, H.C., 1977. Use of the high-protein blue-green algae *Spirulina* sp. as feed for shrimp larvae. *Chin. Fish. Mon.*, 290:2-7.
 81. Teshima, S. and A. Kanazawa, 1983. Effects of several factors and survival of the prawn larvae reared with microparticles. *Bulletin of the Japanese Society of Scientific Fisheries*, pages 1893-1896.
 82. Ting, Y.Y., T.T. Lu, and M.N. Lin, 1977. Experiment on propagation of *P. occidentalis*. *Chin. Fish. Mon.*, 292:22-28.
 83. Treece, G.D. and M.E. Yates, 1988. Laboratory manual for the culture of penaeid shrimp larvae. Sea Grant College Program publication TAMU-SG-88-202, Texas A&M University, College Station, TX. 95 pages. (Reprinted 1990).
 84. Treece, G.D. and J.M. Fox, 1987. The establishment of a successful *P. monodon* hatchery in Japara, JAVA. *Journal WAS* 18(1):20A. Aquaculture Communiques #72.
 85. Treece, G.D. and N. Wohlschlag, 1987. Raising food organisms for intensive larval culture. Chamberlain et al., (Eds.) 1987; *Manual on Red Drum Aquaculture* (out of print). 1990 update available from Texas A&M University Sea Grant College publication TAMU-SG-90-603, entitled "Red Drum Aquaculture." (p. 57-76).
 86. Treece, G.D., 1985. Larval Rearing Technology, Sect. III pp. 43-64 In: Chamberlain et al., 1985; *Texas Shrimp Farming Manual* (out of print).
 87. Tseng, W. 1987. *Shrimp Mariculture, A Practical Manual*. Chien Cheng Publisher, Republic of China.
 88. Yang, W.T., 1975. A manual for large-tank culture of penaeid shrimp to the postlarval stages. *Sea Grant Technical Bulletin* 31. 94 pp.
 89. Yates, M.E., G.W. Chamberlain, and R.J. Miget, 1987. Effect of long chain highly unsaturated fatty acids on penaeid larval nutrition. *Journal WAS* 18(1):14A. Aquaculture Communiques #46.
 90. Villaluz, D.K., A. Villaluz, B. Ladera, M. Sheik, and A. Gonzaga, 1972. Reproduction, larval development and cultivation of sugpo, (*P. monodon*). *Philip. J. Sci.*, 98:205-236.
 91. Villegas, C.T. and A. Kanazawa, 1980. Rearing the larval stages of the prawn, *Penaeus japonicus* (Bate), using artificial diet. *Memoirs of the Kagoshima University Research Center for the South Pacific*, Vol. 1(1):43-49.
 92. Wilkenfeld, J.S., A.L. Lawrence, and F.D. Kuban, 1983. A reliable small-scale experimental system for rearing penaeid shrimp larvae in a synthetic sea-salt medium. *Crustaceana* (Leiden) 1:72-81.
 93. Yellow Sea Fisheries Research Institute, 1978. Artificial cultivation of penaeid shrimp. *Sci. Publ.* pp. 77 (in Chinese).

Chapter 4

Postlarval Holding and Rearing in Circular Raceways

Penaeus monodon postlarvae are held in circular raceways (Figure 20 and Photo 61) from approximately PL5 (5-day-old postlarvae) until they are sold. Sometimes animals are held to PL18 before they are sold for stocking. The circular, flat-bottomed raceway allows the postlarvae to stay near the bottom, or “become benthic” as they would if allowed to develop naturally but cannot do in the conical larval-rearing tank.

The circular raceways are also equipped with habitats or small-meshed screens of 1 to 2 mm in diameter (Photo 62) to give the postlarvae more surface area in the tank. The PLs will use the nets as a retreat or resting area to avoid currents. These nets encourage the PLs to spread out, reducing their tendency to congregate in areas of static water, overcrowd and consume each other.

Raceway Description

Dian Desa’s Unit II has 15 circular ferrocement race-



Photo 61. Postlarval rearing and holding area.

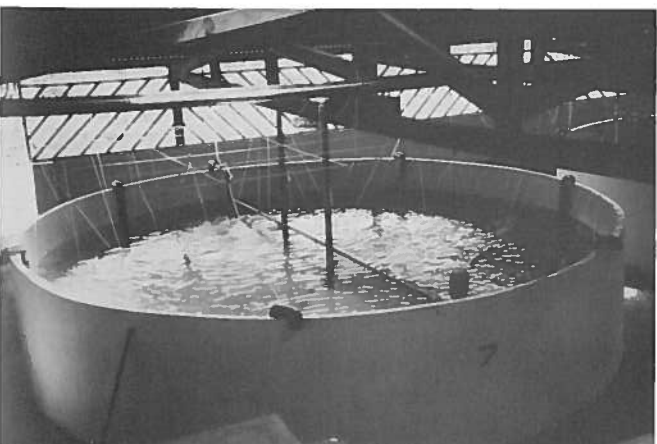

Photo 62. Postlarval holding and rearing tank (15-foot diameter, ferrocement, circular, holding approximately 12 tons, airlifts and screen habitats).

ways that are 15 feet in diameter to hold postlarvae. Each raceway has a maximum volume of 20 tons or 20,000 liters, but the tanks are operated at or below the 13,000-liter mark. Each raceway has a 2-inch PVC inflow, regulated by a gate valve on one side of the tank with the effluent on the opposite side. The tank bottom is sloped slightly toward the drain. The effluent consists of a 2-inch PVC external standpipe regulated by a 2-inch gate valve. The internal effluent consists of a 4-inch to 2-inch reducer sunk into the floor and a 4-inch PVC screened standpipe to retain the postlarvae. A 500- μ m nitex screen is placed on the 4-inch internal standpipe after numerous holes are drilled in the pipe. An air stone is placed at the bottom of the pipe with ample screen surface area to allow debris, food, *Artemia*, etc., to pass through without clogging.

The habitat screens mentioned earlier are suspended in the water column by attaching monofilament lines with clips tied to the end of the line and attached above the tank. The screens are held down by lead weights and/or capped PVC weights. The screens are also arranged in circular or half-moon fashion to maximize water circulation in the tank.

PL5 larvae use the nets; in fact, the Dian Desa Hatchery staff has nicknamed the nets “PL parking lots.” PL8 larvae use the nets more than PL5s, while PL4s do not use the net much at all, but spend most of their time in the water column or on the bottom.

Raceway Tank Preparation and Operation

The raceway tanks are prepared by cleaning them with a chlorine solution. A 100-ppm solution is used the first time the tank and associated parts are used; thereafter, a 5-ppm solution is sufficient for disinfection. The tank is cleaned, rinsed and allowed to air dry before the final filling and flushing period. After filling it is a good idea to aerate the tank heavily for several hours before introducing PLs and also to check for the presence of chlorine with the Hach seawater test kit. If even a trace of chlorine is detected, stocking should be postponed until it has been neutralized.

The volume is calculated after disinfection and filling. There are 1,000 liters in the tank for each 5 centimeters of depth. This gives a rough estimate of the volume. Use the following formula (also found in Chapter 2) for an accurate method of determining the volume. An accurate volume should be obtained before setting the flow rate or adding chemicals and feed. The formula is as follows:

$$\text{Volume} = \frac{3.14 (d)^2 \times h}{4}$$

whereas; 3.14 = 22/7, d = diameter (inside) of tank in centimeters and h = water depth in centimeters. The result should read in cubic centimeters (cc). (1 cc = 1 ml, 1000 ml = 1 liter).

Example: PL raceway tank

$$\text{Vol.} = \frac{22/7 (d)^2}{4} \times h \quad V = \frac{3.14 (500)^2}{4} \times 65\text{cm}$$

$$d = 500 \text{ cm} \quad V = \frac{785,000}{4} \times 65 \text{ cm}$$

$$h = 65 \text{ cm}$$

$$V = 12,756,250 \text{ cm}^3$$

$$V = 12,756 \text{ liters}$$

Flow rate in the raceway is set at 100 percent exchange per 24 hours. This means a flow rate of 531 liters per hour or 8.85 liters per minute for a tank of this volume. Water inflow is spread out and forced in a circular flow. A 1-inch pipe is supported across the diameter of the tank, just above the water level. Approximately ten small holes (2 mm in diameter) are drilled in a row on half of one side of the pipe. Ten small holes are also placed on the opposite end and opposite side of the second half of the pipe. When a 100 percent exchange of water is applied to the tank via the distribution pipe, the force of the water jets encourages directional flow. Six 2-inch PVC airlifts are also positioned evenly around the outside walls of the tank and the flows from these airlifts are also oriented to encourage flow and maximize circular-tank design. Either an airstone or two directional airlift pipes should be placed in the center of the tank to keep larvae and debris from settling there.

As a final preparation before stocking PLs in the raceway, a fungicide is added to prevent the larvae from being contaminated by fungi (*Lagenidium*, etc.). See Table 1, Chapter 3, "Suggested Larval Culture Sequence and Postlarval Feeding," for preventive amounts and a schedule for treatment. Fifty ml Treflan/m³ seawater is added from a 5-ppm solution of Treflan. Treflan from the United States is 44.5 percent active, so a special formula was used to calculate the amount for a 5-ppm solution (0.01 ml of 44.5 percent active Treflan was placed in one liter of distilled water to obtain the 5-ppm solution). From that 5-ppm solution, the 50 ml/Ton treatment was taken.

Once the seawater filtration and treatment systems were fully operational at the Dian Desa Hatchery (UV system was installed as planned, etc.), these preventive treatments were not necessary.

Raceway Stocking

When all preparations are complete, the raceway is ready to be stocked. Somewhere around 10,000-12,000 PL4s/m² (600 PL4s/ft²) should be stocked, or approximately 150,000 PLs per raceway. When all 15 raceways are stocked at this density, the hatchery will have a carrying capacity of more than 2 million PLs. Further testing with habitats may show that stocking densities can be increased with proper management.

PL4s are siphoned directly from the larvae-rearing tanks to the raceways below them. With a 100 percent water exchange per day, any residual contaminated water coming from the LRT will be flushed out. The advantages of adding algae and six *Artemia*/ml from the LRT volume offsets any contamination threat and, if proper conditions have been maintained in the LRT, it will help to maintain a stability for the larvae during the transfer. To feed animals in 12,756 liters would take more than 76 million *Artemia* nauplii or about 383 grams of cysts. Transferring



Photo 63. Feeding postlarvae a finely ground pellet.

the LRT contents cuts this by one third and gives a savings of 128 grams of *Artemia* cysts. If water quality is known to be very poor in the LRT, it may be necessary to collect larvae in a screened bucket, but this should be done only if needed. Concentrating PLs and handling them, even if slowly and gently, usually results in stress and some mortality (sometimes as high as 50 percent).

Postlarval Feeding

(Photo 63) The postlarval feeding regime consists of calculating 100 percent of the biomass in the tank (assuming PL1s weigh 0.0008 g each, PL5s weigh 0.005 g each and PL20s weigh 0.02g each and are approximately 1 cm long). These calculations have worked well thus far and have maintained more than 200,000 larvae in Dian Desa's raceways with very little mortality. There must be a fairly accurate population estimate when the animals are placed in the tank as accurate population estimates are questionable after the PLs are in the raceway. Estimation of mortalities removed during siphoning and cleaning routines would be very time-consuming, but possible. President's # NEW 1 feed is given to the PLs at 100 to 200 percent/body weight/day. The feeding times are divided into at least four times a day (0700, 1200, 1600 and 2200 hours). President's # NEW 1 is a finely ground, 40-percent protein level feed made in Taiwan and is an excellent pellet to start feeding at PL6. Use of continuous wheel-type feeders is an efficient way of offering the PLs a continuous versus intermittent source of nutrition.

The standard President's # NEW 1 feed consists of the following ingredients:

Protein	34.8 percent
Lipid	2.8 percent
Fiber	3.4 percent
Ash	16.0 percent
Moisture	13.0 percent
Calcium	5.7 percent
Phosphorus	2.6 percent
Water stability	24-36 Hours

Artemia are also used for food, starting at 6/ml at PL4 and tapering off completely by PL11 (see Table 1 for feed types and amounts for the various stages and ages). If temperatures have been maintained at 28°C, ±1°C, a PL11 should be large and strong enough to swim against a

gentle current in the tank. It should be able to move freely to the bottom to feed and return to the net habitat to rest. If temperatures have been lower than the optimum, then *Artemia* may be required as feed until the animals have been observed swimming freely in the tank and not being constantly swept around by the currents. In other words, an animal grown at 26°C would not be able to accept a pellet diet as its only food source as would the same aged animal that had been held in 28°C. A diet that stays in the water column is required if the animal is small and weak.

The guideline shown at the bottom of the page is recommended for feeding PLs at Dian Desa if the water temperature is maintained at 28°C, ±1°C:

Table 4 gives an alternate postlarval-feeding guideline/feed requirement scheme and estimated feed costs per month for the Dian Desa hatchery.

It is recommended that the volume of the raceway be kept around 12 to 13 tons for greater temperature stability. A small-meshed screen bucket can be placed to catch the *Artemia* in the effluent. These *Artemia* can be fed algae and returned to the tank as a good food source or a smaller screen can be placed to retain the *Artemia*, if small amounts of algae are added to the raceway each day for them. This ensures a good food source. Excess food and metabolic wastes are removed by siphoning necessary (Photo 64).

Daily Inspection

A daily inspection of animals in each tank is necessary to detect potential problems. Samples of the animals should be observed under the microscope each morning, looking at the following characteristics:

- Guts (full or empty)
- External debris
- Diseases
- Growth
- Eye surface
- Gills
- Periopods
- Pleopods
- Telson spines
- Uropod seatae
- General pigmentation or color
- Length of animal

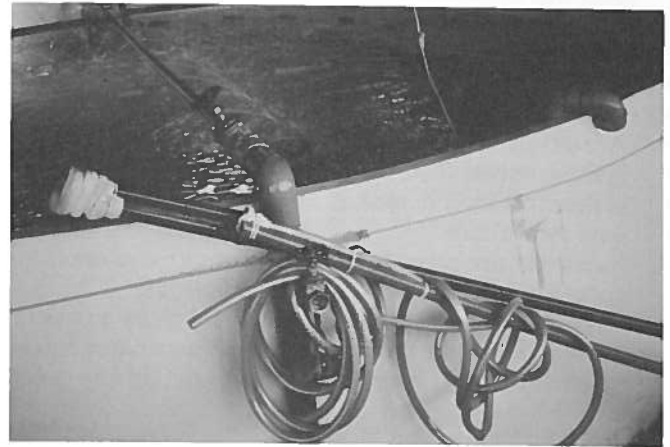

Photo 64. Siphon used to clean PL holding tank when necessary.

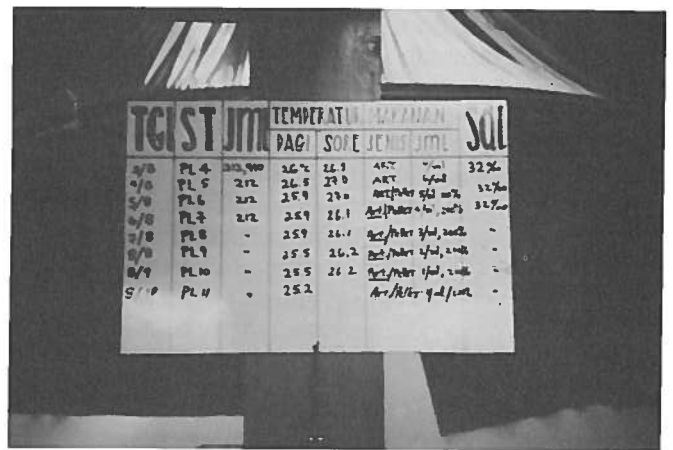

Photo 65. Postlarval rearing and holding data board (formica board located near the tank).

Stage	<i>Artemia</i> /MI	President's # New 1
PL4	6	-
PL5	6	100 percent body weight (25 percent x 4 times/day)
PL6	5	200 percent body weight (50 percent x 4 times/day)
PL7	4	200 percent body weight (50 percent x 4 times/day)
PL8	3	200 percent body weight (50 percent x 4 times/day)
PL9	2	200 percent body weight (50 percent x 4 times/day)
PL10	1	200 percent body weight (50 percent x 4 times/day)
PL11	0	200 percent body weight (50 percent x 4 times/day)
PL12	-	200 percent body weight (50 percent x 4 times/day)
PL13	-	200 percent body weight (50 percent x 4 times/day)
PL14	-	200 percent body weight (50 percent x 4 times/day)
PL15	-	200 percent body weight (50 percent x 4 times/day)
PL16	-	200 percent body weight (50 percent x 4 times/day)
PL17	-	200 percent body weight (50 percent x 4 times/day)
PL18	-	200 percent body weight (50 percent x 4 times/day)

After this inspection, each tank should be individually treated in accordance with the findings. The following observations should also be noted:

- Is waterflow 100 percent
- Are airlifts working
- Are animals spread out evenly
- Is there excess food on the bottom of tank
- Is there no food in tank
- Any mortalities
- If *Artemia* are being fed, is there enough and are they spread out evenly or lying on the bottom.

All of these observations should be made by a person experienced in postlarval-rearing who is capable of reacting positively to the observations. It will not do any good to make the observations and do nothing about them.

Diseases and Treatments at Dian Desa

The diseases and treatments are almost the same for postlarvae as they are for larval rearing except that the treatments are a little stronger in some cases with postlarvae than with zoea. (Consult Chapter 3 on signs of stress, diseases and treatments in the larval-rearing section and consult Table 1 for treatment amounts and preventive levels and Table 7 in Chapter 6 for a list of diseases and their control methods.)

The following is a list of diseases and type of treatment:

- **Bacteria** Shows up as necrosis and red nerve-ending in the tail and head regions, general overall weakened condition, not eating, empty guts. Treat with Chloramphenicol (2-10ppm).
- **Zoothamnium** Shows up on the exoskeleton almost overnight. Treat with 1ppm malachite green.
- **Lagenidium** Show up on the exoskeleton almost overnight. Treat with 50 ml/Ton, 5-ppm solution of Treflan. (NOTE: According to Williams *et al.*, 1986, treflan (triflurain) is rapidly lost by aeration, photodegradation (light) and absorption by algae and needs to be administered drop by drop for 12 hours per day.

Each of these treatments should be done with static water conditions or should be done on a daily basis if a flow is maintained.

Records

All observations and data are kept on the postlarval holding and rearing data log, which is kept on a clipboard (or formica board, Photo 65) near the culture tank (see Table 5).

Identification of Postlarvae and Recognizing Healthy, Desirable or Undesirable Larvae

The "rule of thumb" for selection of good *Penaeus monodon* postlarvae by buyers in Indonesia was to "look for the long black cigars." New studies from Taiwan have indicated that *P. monodon* postlarvae can be selected by using the following criteria:

- A ratio of hepatopancreas height to tail muscle height

is used. Postlarvae with a 5:1 ratio have been found to have the most success. The best larvae may not be the most colorful or the most active. In fact, hyperactivity has been associated with stress.

- Fatty acid composition of postlarvae has also been used to evaluate postlarvae quality (E. Arellano, 1990 WAS Conference in Halifax). A pH-stress test (4.5-7.5) was applied to animals to evaluate the physiological condition of the larvae. Higher resistance was present in the postlarvae when the body composition was high in highly unsaturated fatty acids, (HUFAS) especially with the longer-chain polyenoic acids (C:20:5W3 and C:22:5W3). Also, postlarvae are expected to have a better growth efficiency in ponds (study performed at the Department of Marine Science, ESPOL, Ecuador).

The following are tips for buying and stocking healthy postlarvae:

- **Tail**
A PLs tail should be noticeably open. The preferred age of PL at stocking is PL 18+ for *P. Monodon* and PL 5-10 for *P. Vannamei*.
- **Color**
Good quality PLs have transparent bodies with deep rust-like, greyish or dark streaks along the body. Those with brown to black coloration are still acceptable. Postlarvae that perform poorly are those showing signs of red or pink coloration which can be directly related to rearing or transport stress.
- **Activity**
PLs should visibly be strong. They should be actively swimming from side to side). Active PLs swim against the current when the water is agitated or whirled. When in a basin they may not always be moving, but will react to a tap on the side of the bowl, movement in the water, or shadows.
- **Size**
At PL20, the average length of *P. monodominis* about 18 mm. To the trained technician or grower, the normal length at a certain age can be easily detected. The PL size should be uniform and any significant variation is indicative of different age levels. Growers can generally accept age variations so long as size differences are minimal.
- **Appearance**
PLs are inspected for presence of infestations and other physical defects or abnormalities, such as debris adhering to the body and swimmerets, broken rostrum, crooked body, etc. Healthy PLs have a generally clean appearance and have no physical abnormalities.
- **Feeding**
Observation of good feeding requires a field microscope for exact determination. Healthy fry feed actively and have a full digestive tract, unless there is no food available, such as after a long shipment. If you observe fry at a hatchery and notice that the gut is empty, beware. When animals are sick or stressed they usually don't eat.
- **Clean shell**
A clean shell indicates that the animal is growing fast

Table 4. Alternate Postlarval Feeding Guideline/Feed Requirement/Feed Costs per Month

Age	Tank Type	Number Diet Type	Total % Diet	Feeding Art/PL/Day µg Feed/PL/Day	Number of Shrimp	Feed Total Art or Gms Feed	Artemia Per MI	Prod. Effici.	Total Cysts or Gms Feed Used	Cost Per	Total Cost /Run (Rp)	Runs/ Month
M1	LRT	ARTEMIA	100	23	260000	5980000	1.71	.7	8542857.	.00034	2904.571	30
M2	LRT	ARTEMIA	100	26	250000	6500000	1.86	.7	9285714.	.00034	3157.143	30
M3	LRT	ARTEMIA	100	34	240000	8160000	2.33	.7	11657143	.00034	3963.429	30
PL1	LRT	ARTEMIA	100	45	230000	10350000	2.96	.7	14785714	.00034	5027.143	30
PL2	LRT	ARTEMIA	100	67	220000	14740000	4.21	.7	21057143	.00034	7159.429	30
PL3	LRT	ARTEMIA	100	100	210000	21000000	6.	.7	30000000	.00034	10200	30
PL4	LRT	ARTEMIA	100	122	200000	24400000	6.97	.7	34857143	.00034	6413.71	30
PL5	RACEWAY	ARTEMIA	100	164	100000	16400000	2.09	.7	23428571	.00034	7965.714	60
PL6	RACEWAY	ARTEMIA	100	222	99000	21978000	2.8	.7	31397143	.00034	10675.03	60
PL7	RACEWAY	ARTEMIA	80	394	98000	38612000	4.92	.7	55160000	.00034	18754.4	60
PL8	RACEWAY	PELLET	20	168	98000	16.46		1	16.46	2.75	45.265	60
		ARTEMIA	60	322	97000	31234000	3.98	.7	44620000	.00034	15170.8	60
PL9	RACEWAY	PELLET	40	365	97000	35.41		1	35.41	2.75	97.37	60
		ARTEMIA	40	242	96000	23232000	2.96	.7	33188571	.00034	11284.11	60
PL10	RACEWAY	PELLET	60	616	96000	59.14		1	59.14	2.75	162.63	60
		ARTEMIA	20	139	95000	13205000	1.68	.7	18864286	.00034	6413.857	60
PL11	RACEWAY	PELLET	80	947	95000	89.97		1	89.97	2.75	247.41	60
PL12	RACEWAY	PELLET	100	1112.49	94000	104.5741		1	104.5741	2.75	287.5787	60
PL13	RACEWAY	PELLET	100	1104.96	93000	102.7613		1	102.7613	2.75	282.5935	60
PL14	RACEWAY	PELLET	100	1098.26	92000	101.0399		1	101.0399	2.75	277.8598	60
PL15	RACEWAY	PELLET	100	1092.5	91000	99.4175		1	99.4175	2.75	273.3981	60
PL16	RACEWAY	PELLET	100	1086.23	90000	97.7607		1	97.7607	2.75	268.8419	60
PL17	RACEWAY	PELLET	100	1080.94	89000	96.20366		1	96.20366	2.75	264.5601	60
PL18	RACEWAY	PELLET	100	1075.77	88000	94.66776		1	94.66776	2.75	260.3363	60
PL19	RACEWAY	PELLET	100	1071.19	87000	93.19353		1	93.19353	2.75	256.2822	60
PL20	RACEWAY	PELLET	100	1066.55	86000	91.7233		1	91.7233	2.75	252.2391	60
PL21	RACEWAY	PELLET	100	1062.5	85000	90.3125		1	90.3125	2.75	248.3594	60
PL22	RACEWAY	PELLET	100	1058.41	84000	88.90644		1	88.90644	2.75	244.4927	60
PL23	RACEWAY	PELLET	100	1054.74	83000	87.54342		1	87.54342	2.75	240.7444	60
PL24	RACEWAY	PELLET	100	1051.22	82000	86.20004		1	86.20004	2.75	237.0501	60
PL25	RACEWAY	PELLET	100	1047.67	81000	84.86127		1	84.86127	2.75	233.3685	60
		PELLET	100	1044.44	80000	83.5552		1	83.5552	2.75	229.7768	60

Artemia cost for producing 160,000 PL 25 179353.3 Rp = US \$ 153.29

Feed costs for producing 160,000 PL25 8283.8 Rp = US \$ 7.08

(Exchange at that time was 1 RUPIAH = US\$0.00117 1,000 Rp - US\$1.17)

and molting frequently. Slow growth is indicated by the presence of protozoans, other dirt and necrosis (black spots) on the shell.

Good muscle development

Using a microscope, muscle development can be seen in the sixth tail segment. The muscle should completely fill the shell from the gut down to the underside. In older fry (PL22 and up) this may be pigmented and hard to see. When the PL is stressed the muscle has a "grainy" look (much like the grain in wood) and is greyish or brown in color. Healthy fry have a clear, smooth muscle.

In most hatcheries, muscle development is carefully monitored. Muscles are highly susceptible to stress such as rapid temperature and salinity changes. Even when fry appear healthy, active and are feeding, if the tail muscle is grainy, the fry are stressed. If the muscle is clear and thick, then the fry also meet the other criteria: full gut, clean shell and good color.

Many criteria have been adopted by farmers for judging postlarval quality. These have been discussed by Motoh and Buri, 1981, Parado-Estapa, 1988 and more recently by Fegan, 1992. The most important of these is stage of development along with size, age, stress tests and physical condition. The following physical features can be used to determine PL quality of *P. monodon*:

Feature	Unsuitable	Suitable
6th abdominal segment	Longer than carapace length	Shorter than carapace length
Rostral spine formula	1-5 dorsal 1-2 ventral	6-7 dorsal 2-3 ventral
Gill system	Incomplete	Complete
Behavior	Planktonic	Benthic

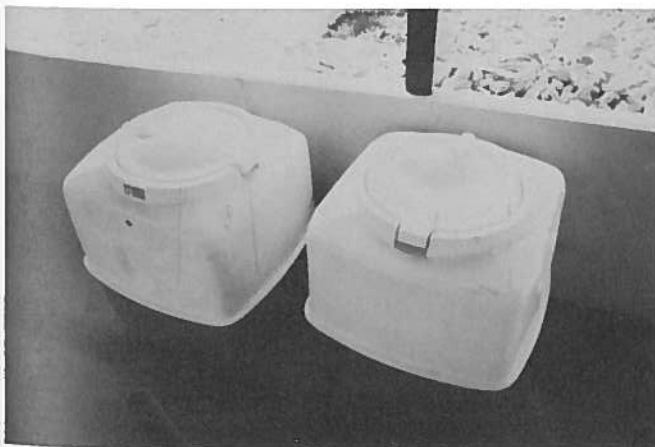

Photo 66. 1,000-liter plastic containers used to transport postlarvae.

Harvesting Postlarvae

When postlarvae are sold or ready to be stocked into ponds they may be drain-harvested into a harvest basin such as the one in Figure 14. Postlarvae may then be chilled to 18°C and boxed in styrofoam coolers, with 1,000 PL's/liter of seawater, and shipped for long distances by air freight. Usually 10 liters of seawater are placed into each box, which is equipped with a double plastic bag. The inner bag is then filled with pure oxygen and the two bags are sealed in some manner such as rubber banding or other banding devices.

For transporting shorter distances, postlarvae may be concentrated (after harvesting) into containers such as those in (Photo 66) 1,000 liter plastic containers, aerated, and transported to the ponds for acclimation. (Photo 67) shows an example of a fiberglass postlarval transport tank. The tank is equipped with internal standpipe and screened overflow. When postlarvae arrive at the pond, a 12-volt submersible pump is placed into the pond. Pondwater is pumped into the tank until acclimation is complete. Then the standpipe is removed and postlarvae are released into the pond through a large flexible hose. The hatchery may also start some of the acclimation by lowering the salinity before the animals leave. Postlarval transport, acclimation and receiving is covered in **Practical Manual for Semi-Intensive Commercial Production of Marine Shrimp** by Jose Villalon, 1991 (Sea Grant College Program, Texas A&M University, Publication 91-501).

Selected References

1. Bagarinao, T.U., N.B. Solis, W.R. Villaver 1986. Important fish and shrimp fry in Philippines' Coastal Waters: identification, collection and handling. **Aqua. Ext. Manual No. 10.** ISSN 0115-5369:52 pp.
2. Baumann, R.G.H. and D. Jamandre 1990. A practical method for determining quality of *Penaeus monodon* (Fabricius) fry for stocking in grow out ponds. in M.B. New, H. de Saram and T. Singh (eds.) Proceedings of the Aquatech conference on Technical and economic aspects of shrimp farming. **Publ.INFOFISH.** Kuala



Photo 67. Postlarvae hauling tank.

- Lumpur.
3. Briggs, M. and J.A. Brown 1991. Intensive rearing of postlarval *Penaeus monodon* in a concrete nursery tank system. Paper pres. at 22nd Ann. Meeting of the World Aquaculture Society, San Juan, Puerto Rico.
 4. Charmantier, G., N. Bouaricha, M. Charmantier-Daures, P. Thuet and J-P. Trilles 1989. Salinity tolerance and osmoregulatory capacity as indicators of the physiological state of penaeid shrimps. **EAS Special Publ. No. 10:65-66.**
 5. Cook, H. 1965. A generic key to the protozoen, mysis and postlarval stages of the littoral penaeidae of the N.W. Gulf of Mexico. **Fish. Bull. 65(2):437-447.**
 6. Dalla Via, G.J. and C. Lederer 1989. Intermediary metabolism in *Penaeus vannamei* after acute locomotory stress. **EAS Special Publ. No. 10:285.**
 7. Fegan, F.F. 1992. Recent developments and issues in the penaeid shrimp hatchery industry. In: Wyban, J., (ed.) **Proc. of Special Session, WAS. 1992.pp.55-70.**
 8. Loesch, H. and H. Avila 1965. Claves para identificaion de camarones peneidos de interes comercial en el Ecuador (Identification keys for commercial Ecuadorian penaeid shrimp). **Institucionacional de Pesca Del Ecuador. Boletin Cientifico Y Tecnico. Guayaquil, Ecuador.**
 9. Mallikarjuna, R. and V. Gopalkrishnan 1989. Identification of juveniles of the prawns *P. monodon* and *P. indicus*. **IPFC/Tech. 13:4p.**
 10. Maugle, P. 1988. Post-larvae (sic) shrimp mortality study. **Artemia Newsletter 8, Publ. Artemia Reference Centre, Ghent, Belgium.**
 11. Mohamed, K.H., P.V. Rao and M.J. George 1970. Postlarvae of penaeid prawns off S.W. Coast of India with key to identification. **FAO Fish. Reports 57(2):489-504.**
 12. Motoh, H. and P. Buri 1981. Identification of postlarvae of the genus *Penaeus* appearing in inshore waters. **Res. Crust. No11:pp.86-94.**
 13. Nietes, A.D. 1990. The effect of feed types/forms on the growth and quality of *Penaeus monodon* postlarvae. **Masters Thesis, Asian Institute of Technology, Bangkok, Thailand.**
 14. Parado-Estapa, F.D. 1988. Selection, transport and acclimation of prawn fry. In "Technical Considerations for the management and Operation of Intensive Prawn Farms" Y.C. Chui, L.M. Santo, R.O. Juliano (eds.) **Publ. U.P. Aquaculture Society, 172p. Iloilo City, Philippines.**
 15. Perez Farfante, I. 1970. Diagnostic characters of juveniles of shrimps. *P. azteus*, *P. duorarum*, and *P. brasiliensis*. **U.S. Dept. Comm. NOAA Rep. 559:1-26.**
 16. Tackaert, W., P. Abelin, P. Dhert, P. Legere, D. Grymonpre, R. Bombeo, and P. Sorgeloos 1989. Stress resistance in postlarval penaeid shrimp reared under different feeding procedures. Presented at Aquaculture '89, Los Angeles, U.S.A., Feb. 12-14, 1989.
 17. Yunker, M. 1990. Tips for buying and stocking healthy fry. Pages 102-103 in D.K. Akiyama (ed.) **Proceedings of the Southeast Asia Shrimp Farm Management Workshop. Publ. American Soybean Association, Singapore.**

Chapter 5

Alternate Production Strategies for the Yayasan Dian Desa Hatchery

This supplements that in Chapter 1 under "Culture Tanks." The intent is to suggest that a new hatchery should produce at maximum capacity for a 24-month period until ideal capacity is determined.

Maturation

Two tanks with 20 males and 20 females in each would be enough if procedures are followed as described in Chapter 2 of this manual. Sell all excess nauplii or flush the remainder.

Larval Rearing

If a larval-rearing tank is stocked every ten days with N6s at 28°C, plus or minus 1°C, it will be possible to obtain three batches of PLs per month. Stock with 400,000 N6s or about 100 per liter. Expect at least a 50 percent survival rate or 200,000 PLs x 3 per month = 600,000 PLs per LRT x 11 LRTs = 6,600,000 PL3s.

Postlarval Rearing

Stock 15 raceways twice a month with 220,000 PL3s (holding the PL3s for 15 days at 28°C, plus or minus 1 and selling). Expect at least 50 percent survival rate in PL holding, or 3.3×10^6 PL18s per month.

Alternate Production Strategies

To produce 3 million PL18s per month, another production strategy can be used. It is a bit more complicated than just simply trying to keep all the tanks full, but if there is an efficient production manager at the site, this method can be used.

Stocking all 11 LRTs with 400,000 larvae each (100/liter) requires 1 million nauplii per day for four days. Stock on day 1, 2, 3 and 4. Harvest PL3s on day 10, 11, 12 and 13 if tank temperatures have been maintained at 28°C. Restock LRTs on the same days that they are harvested. Stock either eleven raceways with the first stocking and then four raceways ten days later, or stock eight raceways in the first stocking and seven raceways ten days later. In both cases production will work out to thirty raceways per month at 100,000 PL18s each, or 3 million PLs. Each raceway is stocked with 200,000 PL3s that are held for 15 days (to produce PL18s). This production rate can be achieved at the Dian Desa Hatchery with proper management. Judging from the results of the trial runs conducted in July and August 1987, and from the maturation trials in July and August 1986, these are conservative estimates. With optimal conditions and proper disease management (preventive program) and/or a better water-treatment system, production could be pushed well above 3 million PLs per month. A schematic of this system follows.

Day	LRT Stocked	LRT Harvested	Raceway Stocked	Raceway Harvested
1	2.75			
2	2.75			
3	2.75			
4	2.75			
5				
6				
7				
8				
9				
10	2.75	2.75	2.75	
11	2.75	2.75	2.75	
12	2.75	2.75	2.75	
13	2.75	2.75	2.75	
14				
15				
16				
17				
18				
19	2.75	2.75	2.00	
20	2.75	2.75	2.00	
21	2.75	2.75		
22	2.75	2.75		

Day	LRT Stocked	LRT Harvested	Raceway Stocked	Raceway Harvested
23				
24				
25				2.75
26				2.75
27				2.75
28	2.75	2.75	2.75	
29	2.75	2.76	2.75	
30	2.75	2.75	2.75	
31	2.75	2.75	2.75	
1				
2				2.00
3				2.00
4				
5				
6	2.75	2.75	2.00	
7	2.75	2.75	2.00	
8	2.75	2.75		
9	2.75	2.75		
10				
11				2.75
12				2.75
13				2.75
14				2.75
15	2.75	2.75	2.75	
16	2.75	2.75	2.75	
17	2.75	2.75	2.75	
18	2.75	2.75	2.75	
19				
20				2.00
21				2.00

Day	LRT Stocked	LRT Harvested	Raceway Stocked	Raceway Harvested
22				
23				
24	2.75	2.75	2.00	
25	2.75	2.75	2.00	
26	2.75	2.75		
27	2.75	2.75		
28				
29				2.75
30				2.75
31				2.75
1				2.75
2	2.75	2.75	2.75	
3	2.75	2.75	2.75	
4	2.75	2.75	2.75	
5	2.75	2.75	2.75	
6				
7				2.00
8				2.00
9				
10				
11	2.75	2.75	2.00	
12	2.75	2.75	2.00	
13	2.75	2.75		
14	2.75	2.75		
15				
16				2.75
17				2.75
18				2.75
19				2.75

NOTE: The first month's production will not show the 3 million postlarvae, but the following months will each show this production if tanks are harvested and restocked according to schedule and there are no other complicating factors.

Chapter 6

Shrimp Toxicology and Shrimp Diseases

Introduction

The purpose of this chapter is to review information available on the pollution ecology and diseases of representative species of penaeid shrimp. Data and information from both field and laboratory studies, as well as information reported in literature, are used. As our ocean waters continue to be degraded by human sources, shrimp toxicology and diseases will become pressing issues, especially for the hatchery operator who must maintain pristine-water conditions.

Shrimp Toxicology

(Couch, 1979, plus updates to 1990)

The majority of available reports regarding pollution and penaeid shrimp (e.g. Overstreet, 1988) concern studies involving the commercially-valuable penaeid shrimp of the U.S. Atlantic states and Gulf Coast. Therefore, most of the information presented here is related to the following three species: *Penaeus duorarum* (pink shrimp), *Penaeus aztecus* (brown shrimp), and *Penaeus setiferus* (white shrimp), all Atlantic and Gulf of Mexico species. Reference to other species of penaeid and some nonpenaeid crustacea are made when specific studies contribute significantly to our understanding of the pollution ecology of shrimp.

This section covers the following pollutant categories and situations: organic-chemicals other than petroleum and related compounds, heavy metals, biological agents, and interactions of pollutants and other factors. Under each of these divisions all known toxicity and specific tissue, organismic, population and ecological effects are reviewed. Further, the uptake, transport, and fate of pollutants is discussed and how they may affect the ecology of penaeid shrimp. For more details on references to material in the Toxicology section of this chapter refer to Couch 1979, Overstreet 1988, and Johnson 1989.

Organic Chemicals Other than Petroleum

Industrial Organic Chemicals

The last four decades have witnessed the unprecedented release of synthetic organic chemicals into the natural environment. These so-called xenobiotics have numerous origins and uses and are rarely innocuous upon entering natural waters. Because penaeid shrimp occupy estuaries during a significant portion of their life cycles, they are exposed to pollutants characteristic of industries associated with the estuaries. Relatively few industrial pollutants have been investigated specifically with regard to the ecology of penaeid shrimp.

Polychlorinated Biphenyls

Polychlorinated biphenyls (PCBs) are industrial pollutants that may strongly affect penaeid-shrimp ecology and aquatic ecology in general. Table 6a presents a summary of how PCBs affect penaeid shrimp.

For many years these industrial chemicals have been present in the aquatic environment as a result of waste effluents, disposal of dielectric fluids, and other industrial sources. It is a well-established fact that certain fresh and marine bodies of water are contaminated with various compounds of PCB. For example, PCBs have been found in water, sediments, and tissues of animals (including penaeid shrimp) from Escambia Bay near Pensacola, Florida.

Considerable research has been done on the effects of PCBs on estuarine species with emphasis on pink and brown shrimp. These two penaeid species were killed by a two-week exposure to 0.9, 1.4, and 4.0 $\mu\text{g}/\text{liter}$ Aroclor 1254 in flowing seawater (United States Environmental Protection Agency, Gulf Breeze, Florida). The minimum concentration causing mortality was 0.9 $\mu\text{g}/\text{liter}$. Penaeid shrimp suffered greatest mortality when exposed during pre-molt (just before molting) and during molt. Most exposed shrimp became lethargic, stopped feeding, and did not dig into the substrate (digging is a normal activity for penaeids). Subtle to dramatic chromatophore changes in the cuticle of exposed shrimp were more frequent and obvious than in unexposed control shrimp.

On the light-microscopical level, no lesions were consistently found that were indicative of PCB exposure in shrimp. However, several interesting cytopathic changes were noted in exposed-shrimp studies with electron microscopy.

Pink shrimp were exposed to 3 $\mu\text{g}/\text{liter}$ Aroclor 1254 in flowing seawater for 30 to 52 days. During these exposures up to 50 percent of the animals died. Both living and dead shrimp were analyzed by gas chromatography and from 33 to 40 $\mu\text{g}/\text{gm}$ Aroclor 1254 was found in their hepatopancreatic tissues. Aroclor uptake in the hepatopancreas was linear with time. Hepatopancreas absorptive cells from exposed shrimp revealed the following departures from those of control shrimp:

- An increased or proliferation of rough endoplasmic reticulum in 30-50 percent of cells.
- Production of membrane whorls with enclosed lipid droplets.
- Nuclear degeneration characterized by the occurrence of vesicles in the nucleoplasm (20-50 nm and 100-700 nm in diameter).

The proliferation of smooth endoplasmic reticulum (ER) in hepatocytes of higher animals has been described

Table 6a. Polychlorinated Biphenyls and Penaeid Shrimp (Couch, 1979)

Compound	Toxicity	Physiological/histological effects	Ecological/environmental implications	References in Couch, 1979
Aroclor 1254	3 µg/liter 30-day exposure caused 50% mortality, pink shrimp 0.9 µg/liter caused some mortality in 14 days, pink shrimp	Lethargy; chromatophore changes; ultrastructural pathology in hepatopancreas cells	Pink shrimp absorbed 1254 from sediments from polluted estuary, loss of burrowing activity-exposure to predators; shrimp could not avoid contamination waters as some fish could. Long life of PCB's in sediments maintain pollution at chronic levels over several years.	Duke <i>et al.</i> Nimmo <i>et al.</i>
Aroclor 1016	10 µg/liter, 96-hour exposed caused 43% mortality 0.9 µg/liter, 96-hour exposure caused 8% mortality, brown shrimp.	None reported	None reported	Hansen <i>et al.</i>

Table 6b. Organochlorine Pesticides and Penaeid Shrimp (Couch, 1979)

Pesticide	Toxicity	Physiological/histological effects	Ecological implications	References in Couch, 1979
Chlordane	96-hour LC 0.4 µg/liter, pink shrimp	None reported	Residues in estuaries from five southern states; effect in nature unknown.	Parrish <i>et al.</i>
DDT (No longer used in U.S.)	18 days LC 0.1 µg/liter, white shrimp	Loss of cations (Na, K) in hepatopancreas; possible ATPase inhibitor.	Death of exposed shrimp takes out possible step in tropic accumulation in nature.	Butler <i>et al.</i> Nimmo <i>et al.</i>
Dieldrin	96-hour LC 0.9 µg/liter, pink shrimp	None reported	Commonly found in estuaries; second most common pesticide in mollusks	Parrish <i>et al.</i> Butler
Endrin	96-hour LC 0.28 µg/liter, pink shrimp	None reported	None reported	Schimmel <i>et al.</i>
Heptachlor	96-hour LC 0.11 µg/liter	None reported	None reported	Schimmel <i>et al.</i>
Hexachlorobenzene	Lethargy in 25 µg/liter and 33% death at 96 hours, pink shrimp.	Hepatopancreas grossly, abnormally white.	Accumulated by estuarine fishes. Exposed shrimp possibly unable to escape predation due to lethargy.	Parrish <i>et al.</i>
Lindane	24-96 hour LC range, 0.17-33 µg/liter; pink, brown, white shrimp	None reported	None reported	Chin and Allan Schimmel <i>et al.</i>
Mirex	7-day LC 1.0 µg/liter, pink shrimp	Delayed toxicity to pink shrimp 4 days after removal from mirex.	Mirex applied as a particle bait in nature may render it unavailable to many organisms.	Lowe <i>et al.</i> Tagatz <i>et al.</i> Markin <i>et al.</i>
Toxaphene	LC nauplius, 22 µg/liter, LC protozoa, 1.8 µg/liter; LC mysis, 1.4 µg/liter, pink shrimp	Differential toxic responses of different larval stages.	Temperature dissolved O ₂ variations affected survival in exposed mysis.	Courtenay and Roberts

as indicative of toxic response to drugs or chemicals such as phenobarbital, dilantin, dieldrin, and carbon tetrachloride. Proliferation of ER has been related to detoxication of poisons and may, in shrimp, represent an attempt on the part of hepatopancreatic cells to metabolize PCB absorbed from the lumen of hepatopancreatic ducts. If this is the case, cellular alterations at the ultrastructural level such as proliferation of ER may be valuable indicators of sublethal effects of certain pollutants in penaeid shrimp.

Another PCB, Aroclor 1016, has been introduced for limited use in the United States. This compound has been tested for toxicity in brown shrimp. Aroclor 1016 was found to have nearly the same toxicity for penaeid shrimp as Aroclor 1254; 0.9 $\mu\text{g}/\text{liter}$ Aroclor 1016 in flowing seawater killed 8 percent of test shrimp in 96 hours; 10 $\mu\text{g}/\text{liter}$ Aroclor 1016 killed 43 percent of test shrimp in 96 hours.

It is apparent that PCBs as pollutants pose a threat to penaeid shrimp that show a high sensitivity to these compounds. In this regard, it has been demonstrated that pink shrimp could absorb a PCB (Aroclor 1254) from sediments taken from a PCB-polluted estuary, Escambia Bay, Florida. It was found that some shrimp showed no avoidance reaction when given choices of clean or PCB-contaminated water. These and other data suggest that PCBs, as pollutants, could have influence on relative survival and abundance of penaeid shrimp in natural waters.

Pesticidal Chemicals

In the last 30 years, many kinds of chemical pesticides have been inadvertently or intentionally released into the environment. Aquatic life is exposed to these compounds because the aquatic portion of the biosphere often behaves as a "sink" or receptacle for these compounds because of runoff or fallout. Some of these pesticides, such as certain organochlorines or their metabolites are refractory to breakdown and thus tend to accumulate in various compartments of the aquatic environment. Shrimp have been found to accumulate certain pesticidal compounds in the laboratory, and feral shrimp have possessed detectable levels of compounds when taken directly from contaminated or apparently "clean" waters. The staff of the U.S. Environmental Protection Agency Laboratory, Gulf Breeze, Florida, has found that over several year of testing, penaeid shrimp generally are far more sensitive to toxic and ecological effects of most pesticides than are fish or mollusks. The effects of some of the well-known compounds are reviewed below. Further work has been reported with monitoring pesticides in aquaculture by Vogt (1987).

Organochlorines

The following organochlorine pesticides have been studied in regard to organismic and/or ecological effects on penaeid shrimp: chlordane, DDT, dieldrin, endrin, heptachlor, hexachlorobenzene, lindane, mirex, and toxaphene. Data on the effects are summarized in Table 6b for these pesticides (Couch 1979).

White shrimp that died as a result of DDT exposure (currently banned in the United States) accumulated up to 40.4 $\mu\text{g}/\text{gm}$ DDT and DDE (by-product) in the hepatopancreas after 18 days of exposure to 0.20 $\mu\text{g}/\text{liter}$ in flowing

seawater. Exposure to a DDT concentration greater than 0.01 $\mu\text{g}/\text{liter}$ was lethal to pink shrimp in 28 days. A physiological effect of DDT exposure in pink and brown shrimp was loss of certain cations in the hepatopancreas. Sodium and potassium concentrations in shrimp exposed to 0.05 $\mu\text{g}/\text{liter}$ DDT for 20 days were lower than in those not exposed. Magnesium, however, was not significantly lowered. The significance of reduced cation in the hepatopancreas of shrimp for the pathophysiological behavior of shrimp is not known, but a loss of ATPase activity in ion transport may be indicated. Blood-protein levels have also been found to drop in shrimp exposed to DDT. In acute, high-concentration laboratory exposures, shrimp showed tumors, hyperkinetic behavior and paralysis, all classic signs of DDT poisoning (shrimp did not become paralyzed but sank into lethargy, refused food and then died).

Pink shrimp were more sensitive to dieldrin than were grass shrimp (Palaemonidae) in test exposures. However, both species died when exposed to concentrations of dieldrin in the low parts-per-billion range.

Some juvenile pink and brown shrimp died after laboratory exposure to low concentrations of mirex (Table 6b). However, all survivors from this test died after four days in mirex-free seawater, demonstrating a delayed toxic effect of mirex. Mirex poisoning in shrimp produces loss of coordination, equilibrium and finally, signs of lethargy and paralysis.

Shrimp and blue crabs were exposed to low concentrations of mirex for long periods (30 days or more) and examined for histopathological effects. No pathological effects at the tissue level were found in the animals that were examined. The organs studied were muscle, the hepatopancreas and gonads.

A detailed ecological-monitoring study of the distribution of mirex in oysters, crabs, shrimp, and fishes from estuarine waters from the Gulf of Mexico to Delaware Bay was done. Sampling stations were in Mississippi Sound, Mississippi; Mobile Bay, Alabama; Tampa Bay, Florida; Jacksonville, Florida; Savannah, Georgia; Charleston, South Carolina; Morehead City, North Carolina; Chesapeake Bay; and Delaware Bay. Only shrimp in the Savannah, Georgia, area had detectable concentrations of mirex (0.007 $\mu\text{g}/\text{gm}$ in tissues). The Savannah, Georgia, area has a long history of mirex usage. Mirex does not appear to be as widespread in estuarine regions as are PCBs and DDT. Mirex, usually applied as a particle-bait poison, would not be as directly available to many marine organisms as are broadcast liquids or powder formulations of other pesticides.

The finding of 0.007 $\mu\text{g}/\text{gm}$ mirex in shrimp near Savannah probably reflects a considerable accumulation of mirex by shrimp over a long period of time from possibly extremely-low concentrations in the environment. It was found (Table 6b) that 25 percent of the pink shrimp tested died in the laboratory after seven days of exposure to only 1.0 $\mu\text{g}/\text{liter}$ mirex. Therefore, the concentrations of mirex must be assumed to be considerably lower than 1.0 $\mu\text{g}/\text{liter}$ in Georgia estuarine waters. If the aqueous concentrations were above 1.0 $\mu\text{g}/\text{liter}$ few shrimp would probably survive in that area.

Toxaphene differentially affects the early metamorphic stages of pink shrimp (Table 6b). The mysis stage of

pink shrimp is most susceptible to toxaphene, particularly under various temperature and dissolved-oxygen conditions. This might suggest that fluctuations in abundance of juvenile and young-adult penaeid shrimp in toxaphene contaminated waters could result from impact of the pesticide on an early life-cycle stage during periods of changing temperature and/or during periods of dissolved oxygen fluctuation.

Organophosphates and Carbamates

Few organophosphate compounds have been tested on species of crustaceans. However, those compounds tested have been shown to be approximately 1000 times more toxic to shrimp than most other pesticides tested, with penaeid shrimp showing greater sensitivity than fishes or mollusks.

Baytex (Bayer 29, 493) was toxic to penaeid shrimp in the laboratory. Naled (1,2-dibromo-2,2-dichlorethyl phosphate) had little effect in field tests on shrimp. Fast dilution and instability without persistence of compounds may contribute to the lack of mortality of shrimp in field testing of this organophosphate. In the laboratory, Dibrom is lethal to postlarval brown shrimp at 2.0 µg/liter, and at 5.5 µg/liter (= LC50 for 48 hours). It is also lethal to adult pink shrimp. Malathion, at 14 µg/liter, caused hyperactivity, paralysis, and death in penaeids. Parathion's lethal concentration for 48 hours in pink shrimp was 0.2 µg/liter. No histopathogenesis has been reported for penaeids exposed to organophosphates.

In the 1970s, Conte and Parker found that malathion aerially applied to flooded marshes in Texas caused from 14 to 80 percent mortality in brown and white shrimp held in cages. They recommended that malathion not be applied to flooded marshes that maintained shrimp. Caged pink shrimp were not killed in small areas receiving malathion via thermal fogging for mosquito control in salt marshes in northwest Florida. Ralph Gouldy's hatchery in Summerland Key, Florida did have problems with aerial mosquito spraying with malathion and had to run a closed system hatchery during the early 1980's (personal com-

munication). The hatchery now operates under the name GMSB (Joe Mountain and Jim Norris) under the same conditions.

Both organophosphates and carbamates are reported to be potent acetyl-cholinesterase (Ache) inhibitors in the vertebrates. Little evidence of early presyndromic inhibition of Ache activity in the ventral-nerve cord of pink shrimp was found, but inhibition as high as 75 percent was found in moribund shrimp experimentally exposed to malathion.

Carbamate pesticides (e.g. sevin) have not been tested extensively on penaeid shrimp, but sevin may be lethal to other crustacea when applied to field sites in the marine environment. Carbary (sevin) was found to be quite toxic to penaeid shrimp in laboratory tests. Brown shrimp have a 24 to 96 hour LC50 of 2.5 µg/liter, the lowest concentration of sevin reported to kill any crustacean tested.

Petroleum

Annual spillage of oil and oil products into the ocean is over 3 million tons (not including the 1989 Alaskan spill by Exxon). Most of these spills occur in estuaries or near coastal regions of significant biological value. Of particular importance is the fact that many coastal areas effected by oil spills (including potential spill areas) are in penaeid shrimp producing regions. A few detailed studies of ecological and physiological effects of oil on penaeid shrimp have been published (Couch, Anderson).

It was found that when penaeid shrimp were experimentally exposed to oil-contaminated seawater, they accumulated hydrocarbons in their tissues. Table 6c gives information on two forms of water-soluble petroleum products in relation to penaeid shrimp. Aromatic hydrocarbons were accumulated in greater amounts than were alkane hydrocarbons. Bioaccumulation of aromatics increased in proportion to the increase in their molecular weights up to, but not including, the heavier polycyclic aromatics (four to five ring). Brown shrimp (*Penaeus aztecus*) exposed to oil in seawater and then depurated in clean seawater, released accumulated hydrocarbons more rap-

Table 6c. Petroleum and Penaeid Shrimp (Couch, 1979)

Component	Toxicity	Physiological implications	Ecological/ environmental implications	References in Couch, 1979
Water-soluble fraction of Aromatic hydrocarbons	2.9 mg/liter 96-hour LC, brown shrimp juveniles; 1.0 mg/liter 96-hour LC white shrimp juveniles	Differential susceptibilities of postlarvae, early juveniles, and late juveniles of single species i.e., brown shrimp. Postlarvae are more tolerant than juveniles.	Different susceptibilities of different species in same genus, i.e., brown shrimp vs. white shrimp might lead to changes in species composition in polluted regions.	Neff <i>et al.</i>
Louisiana crude oil (water soluble fraction)	19.8 mg/liter 96-hour LC, brown shrimp post larvae	May show chronic toxicity but not as acutely toxic as refined product above.	Brown shrimp postlarvae less sensitive than polychaetes and one fish (<i>Menidia</i> sp.); about equal in sensitivity with two fishes (<i>Fundulus</i> and <i>Cyprinodon</i>).	Neff <i>et al.</i>

idly than clams (*Rangia cuneata*) and oysters (*Crassostrea virginica*). Shrimp can metabolize the hydrocarbons whereas the mollusks have a limited, if any, capability to do this. The higher molecular-weight hydrocarbons are released from shrimp tissues more slowly than lower molecular-weight hydrocarbons. Carcinogenic polycyclic hydrocarbons such as benzo (a) pyrene, therefore, would be retained longer, possibly to exert chronic effects or to be shunted into the human food chain.

Couch (1979) presented results of tests on the water-soluble fractions and oil in water dispersions of four oils (South Louisiana crude, Kuwait crude, refined No. 2 fuel and Bunker C (residual) against brown shrimp postlarvae for toxicity. The tests showed that fractions of refined oils were generally more toxic to penaeid shrimp and to other aquatic species than were the fractions of crude oils. The crustacean species tested, including brown-shrimp postlarvae, were more sensitive to oil fractions than fish species tested (*Cyprinodon*, *Menidia*, and *Fundulus*). The 24-hour median tolerance limit of juvenile brown shrimp exposed to components of No. 2 fuel oil (naphthalenes, methyl naphthalenes, and dimethyl naphthalenes, ranged from 0.77 to 2.51 ml/liter. The naphthalenes were the most toxic components of fuel oils (Anderson *et al.*) to shrimp.

Others have observed considerable interspecies variation in oxygen consumption between different species of marine animals when they were exposed to the same oil-seawater mixtures. Therefore, physiological responses to oil pollution may vary with the test species used, and one cannot predict with certainty which species will be more sensitive to oil.

Studies of detailed pathologic mechanisms of oil toxicity in shrimp have been rarely reported. There have been reports of nonspecific lesions in the cuticular chitin, the lining of the gastric mill and the mouth region, and the proliferation of cells and necrosis in the basal portion of gill filaments of shrimp exposed to sonified crude oil (Couch 1979).

The ecological effects of an oil spill depend, to a large extent, upon the environmental, meteorological, and geographical location.

Heavy Metals

A variety of heavy metals are found as both naturally and anthropogenically-derived components of the estuarine environment. These metals may exist in several oxidation states with different reaction potentials depending on their specific chemistries. Certain heavy metals are pollutants generated by industry. Some may be acted upon by estuarine microbes to produce alkyl-metallic compounds that can be accumulated by estuarine species and are potent toxicants.

Although heavy metals occur naturally in the aquatic environment as a result of weathering and land drainage, in recent years, the use of various metals containing pesticides and fungicides has added large quantities of heavy metals to the aquatic environment (Kumaraguru *et al.*, 1980; Chen *et al.*, 1985). Excessive additions of heavy metals to the aquatic environment could have an adverse effect both on the animals and on people who eat these animals as food. There are a number of reports on the

toxicity of heavy metals to aquatic animals (McLeese and Ray., 1986; Correa, 1977; Del Ramo *et al.*, 1987; Holwerda *et al.*, 1988; Nugegoda and Rainbow, 1988). The biological effects of metals are complicated by their synergistic and antagonistic interactions with other metals (Foster and Morel, 1982) and by metal speciation (Zamuda and Sunda, 1982). For example, zinc influences the toxicity of cadmium (Dunlop and Chapman, 1981) and chelating agents such as Tris, NTA, and EDTA reduce the toxicity of metals by sequestering reactive species (Engel and Sunda, 1979; Muramoto, 1980; Castille and Lawrence, 1981; Lawrence *et al.*, 1981).

EDTA has been used for a variety of purposes (Mark, *et al.*, 1965); one of them as a chelator of heavy metals in aquaculture hatcheries in order to avoid toxic effects of these metals to crustaceans of commercial importance during their early stages of life.

Several studies have been carried out in order to determine the bioaccumulation and toxicity of heavy metals to aquatic organisms (Evans, 1980; Kumaraguru *et al.*, 1980; Muramoto, 1980; Correa, 1987; Del Ramo *et al.*, 1987; Chen and Liu, 1987). Liu and Chen (1987) found that there is a negative linear relationship between hatching rate of *Artemia* cysts in seawater and heavy metal concentration, and Chen and Liu (1987) found that heavy metal concentration in *Artemia* nauplii increased linearly with an increase in the heavy metal.

The heavy metals that can be methylated, such as mercury, tin, palladium, platinum, gold and thallium, pose special threats as environmental pollutants and some should be continuously monitored. Other metals, such as cadmium, lead, and zinc, do not form stable alkyl-metals in aqueous solutions, but may have different modes of toxic action than do the alkyl-metals such as methylmercury, a neurotoxicant. Cadmium, which does not persist as an alkyl-metal in aquatic systems but does as an ion, is a strong cytotoxicant to gill cells of crustacea.

Cadmium (Cd)

Spotte (1970) reported that natural seawater (oceanic) contains 0.00011 ppm cadmium. Unusually-high levels of cadmium have been reported from certain estuaries in which penaeid shrimp commonly occur (i.e. Laguna Madre, Corpus Christi, Texas U.S.A.). This metal is also a pollutant from several industrial effluents into aquatic systems.

It has been observed that in a significant number of pink shrimp exposed to approximately 760 µg/liter cadmium (as CdC 12) for an additional nine days in flowing seawater, an unusual blackening of gills occurred. Unexposed control shrimp did not develop black gills. It was found that the LC50 of cadmium in 30 days was 719 µg/liter, and that during these tests many exposed shrimp developed the black gill syndrome prior to death.

Couch (1979) reported the uptake of cadmium in the tissue of pink shrimp (between 1 and 10 µg/liter Cd in water-elicited uptake, but below 1 µg/liter Cd there was no accumulation of the metal in shrimp tissue). Castille and Lawrence (1981) found that cadmium in a concentration of 20 micromole was lethal to *P. stylirostris* nauplii.

Current values for cadmium concentrations in seawater

ter at 35ppt salinity with standardized nutrient levels is 70 ng/Kg according to Quinby-Hunt and Turekian (1983), or at 0.00011 ppm(Cd²⁺) by Spotte (1970). The level of Cadmium found in Fumba, Zanzibar, East Africa (open ocean site) seawater samples was 0.01 ppm (see Appendix E in Chapter 1 of this manual "Seawater Analyses from Other Areas of the World and Normal Seawater". As a comparison, Fujimura (1989) reported hatchery water samples from Sabah, Malaysia with Cadmium levels of 0.05 ppm. Chen (1981) reported that cadmium concentrations higher than 0.1 ppm might cause mortality of shrimp larvae. Dunlop and Chapman (1981) found that cadmium toxicity can be influenced by the presence of zinc.

Iron (Fe)

According to S.K. Johnson (personal communication), iron is not usually toxic to larval shrimp in the hatchery as such, but it is the precipitant that causes problems. The suggested treatment for a high iron level in seawater is to treat the water by:

- oxidizing (iron)
- chlorinating
- aeration

According to Bill Bray (personal communication) if iron is found in seawater, he uses EDTA up to 15 ppm. Tests conducted by Treece (1981) in St. Croix, U.S.V.I., indicated that 2 ppm EDTA was sufficient in stopping debris from adhering to appendages and assisted larvae metamorphose to the next stage. Useful information can be found in a paper by Chen, Ting, Lin and Lian, 1985, "Heavy metal concentrations in seawater from grass shrimp hatcheries and the coast of Taiwan", (WAS 16:316-332).

Iron and manganese can also be oxidized to the insoluble-oxide forms by ozone. Kjos *et al.*, (1975) were able to reduce iron concentrations in freshwater from 9.54 to 0.07 mg/liter with ozone. Oxygen used in place of ozone reduced the iron concentration to 3.99 mg/liter. Manganese was reduced from 1.21 to 0.71 mg/l by oxygen and to 0.05 mg/l by ozone. Care must be taken with ozone use especially in closed seawater systems because some desirable salts may be oxidized too, thus removing them from the systems. See section on disinfection in chapter 3 of this manual for more detail.

Iron (Fe) or Total Iron levels for Fumba, Zanzibar, East Africa water samples were found to be 0.25 and 0.26 ppm. Iron levels in water samples taken from a mangrove swamp area of Zanzibar, East Africa had slightly higher levels of iron in them than the Fumba samples (an open ocean site). These levels were found to be at 0.30 ppm. (see Appendix E in Chapter 1 of this manual "Seawater Analyses from Other Areas of the World and Normal Seawater". As a comparison, Fujimura (1989) reported hatchery water samples to contain 0.23 ppm iron from Sabah and 0.3 ppm from Guam water samples. Natural seawater has been reported to have 0.02 ppm trace metal iron in it (Sverdrup, Johnson and Fleming, 1970) and Spotte (1970) reported the iron level at 0.01 ppm. Warnick and Bell (1969) reported that the 96 hr. median tolerance limit of iron to aquatic insects, mayflies, stoneflies and caddisflies was 0.32 mg/l. Chen *et al.*, (1985) reported iron levels in

Taiwan's coastal waters as being comparable to U.S. coastal water criterion (Clark, 1975). They did however find some higher concentrations of iron in the seawater from Chyijin/Kaohsiung City, which was caused by industrial pollution and was cause for concern. The iron appeared as divalent in reducing conditions but it was readily oxidized to the trivalent state as a colloid which may also block the gills of shrimp larvae.

Copper (Cu)

Spotte (1970) reported the copper level in normal seawater to be 0.003 ppm. Couch (1979) reported that a copper concentration of 0.5 µg/liter was lethal to nauplii, protozoa and mysis of *P. aztecus* and *P. duorarum* that were exposed in a seawater-brine mixture similar to that derived from desalination plants. The same larval stages were able to grow normally in seawater (35 ppt) containing 0.025 mg/liter copper. Kumaraguru *et al.*, (1980) reported a 96h LC50 of 0.57 ppm copper to *Meretrix casta*. The copper levels found in water samples taken from Fumba, Zanzibar East Africa (open ocean site) and from a mangrove swamp area on the same island were both 0.08 ppm (see Appendix E in Chapter 1 of this manual). Normal seawater has 0.04-0.1ppm copper according to another source (Forstner and Wittman, 1979). Fujimura (1989) reported 0.03ppm in hatchery water from Sabah, Malaysia and Yuan *et al* (1991) reported 0.3-2.1ppm levels of copper from Qingdao, China water.

Mercury (Hg)

Mercury has been reported to exist in natural seawater at a level of 0.000008 ppm (Spotte, 1970). Mercury as a metal has not been suspected to have toxic effects on organisms; however, mercuric salts and methylated mercury are extremely toxic with both short and long-term chronic effects. Mercuric chloride is used in some histological fixative fluids because of its protein-precipitating effects in tissues. Enzymes of liver and other tissues may be bound and their activity may be altered by ionic mercury. These mercuric products were responsible for the 1988 closing of the area around the Alcoa plant in Lavaca Bay, Texas to fishermen.

Couch (1979) reported studies on the uptake and distribution of mercuric chloride in brown shrimp (*P. aztecus*), and also examined the effects of mercuric chloride exposure on the ability of brown shrimp to adjust to salinity changes. They found that after two hours of exposure to 0.5 µg/liter mercuric chloride in seawater, accumulation of mercury in the shrimp was 285 mg/gm with only 9 percent of the mercury in the meat (muscle) and 91 percent in the shell. This suggested that a surface absorptive process for mercury existed in brown shrimp exposed for brief periods. Shrimp obtained off Louisiana's Southwest Pass had natural levels of only 4.6 ng/gm mercury distributed as 64 percent in the muscle and 36 percent in the cuticle, suggesting that chronic exposure results in internal accumulation of mercury. 17 µg/liter ionic mercury is the LC50 (96 hours) for postlarval white shrimp (*P. setiferus*). Chronic exposure of postlarval white shrimp to 1.0 µg/liter for 60 days did not affect respiration, growth, and molting. Chinnayya (1971) found that mercury did decrease respiration in freshwater shrimp, but did not state

the levels present in the water.

Brown shrimp are active regulators of blood chloride levels (ion regulators). Exposure of brown shrimp to mercury and to salinity changes resulted in interference with the shrimp's ability to regulate their internal ion levels to compensate for external-salinity changes. Mercury could prove to be detrimental to penaeid shrimp if the form and amount are sufficient enough to prevent them from adjusting to fresh or high-saline conditions that result from rapid changes in estuaries or tidelands due to seasonal or meteorological extremes.

Zinc (Zn)

According to Chinnayya (1971) zinc in the water column caused a decrease in the rate of oxygen consumption of the freshwater shrimp. Correa (1987) reported a differential reduction in respiration and ammonia excretion in shrimp with increasing concentrations of zinc reporting static 96 LC50 values for zinc at 0.2 mg/L. The Environmental Agency of Japan (1972) set 0.1 ppm zinc as the upper limit allowed in seawater for fisheries activities. Dunlop and Chapman (1981) found that zinc influenced cadmium toxicity. Normal seawater has 0 to 0.1 ppm zinc in it according to Sverdrup *et al.*, (1970) and Forstner and Wittman (1979), respectively. Spotte (1970) reported zinc to be 0.01 ppm in normal seawater. As a comparison, Fujimura (1989) reported zinc levels in hatchery water from Sabah, Malaysia at 0.06 ppm, 0 levels in Hawaii and Guam, and Yuan *et al.*, (1991) reported 0.9-3.2 ppm in Qingdao, China water samples. See Appendix E in Chapter 1 of this manual (Seawater Analyses from Other Areas of the World and Normal Seawater) for a comparison.

Lead (Pb)

Chinnayya (1971) reported that lead decreased oxygen consumption in the shrimp, *Caridina rajadhardi*. Forstner and Wittman (1979) reported the lead level in normal seawater was between 0.005-0.01 ppm, but Spotte (1970) reported it in much lower levels (0.00003 ppm). Seawater analysis in Sabah, Malaysia made by Fujimura, (1989) listed lead levels of 0.14 ppm. Another report by Yuan *et al.*, (1991) from Qingdao, China, listed lead levels in seawater between 0.1-2.0. Seawater samples from Fumba, Zanzibar, East Africa contained 0.08-0.11 ppm traces of lead and 0.08 ppm from a mangrove swamp area on the same island. When samples were taken at the Dispensary site near Fumba, fishermen had a number of boats with outboard motors anchored just offshore, upwind of the sampling station. This is very likely the source of lead found in the slightly higher sample at Fumba. See Appendix E, Chapter 1 (Seawater Analyses from Other Areas of the World and Normal Seawater) for a comparison.

Nickel (Ni)

Spotte (1970) reported the level of nickel in normal seawater to be 0.0054 ppm. The Environmental Agency of Japan (1972) placed a 0.1 ppm upper limit on the element nickel allowed in seawater for fisheries activities.

Manganese (Mn)

Spotte (1970) reported manganese in normal seawater to be 0.002 ppm. The Environmental Agency of Japan

(1972) considers seawater containing in excess of 1 ppm manganese unacceptable for fisheries. Li *et al.*, (1969) studied the distribution of manganese in both the sediments and the interstitial waters of an Arctic deep sea core. They found that the manganese content of the interstitial waters showed a constant increase with depth to about one meter from the top of the core. Many of the shrimp hatcheries in Japan and Taiwan have reported numerous black particles appearing during the larval phases both in the water and on the sides of the tanks. Those black particles when dissolved in sulfuric acid, were found to contain a large amount of manganese. Sano (1979) reported that well water contains manganese as manganese bicarbonate (in its reduced condition). Chen (1983) reported that the higher the carbon dioxide concentration, the greater the chances are of the manganese being mobilized from the manganese containing sediments. The toxicity of manganese to shrimp has not been documented, but Chen *et al.*, (1985) reasoned that large amounts of manganese particles may block the gill thus inhibiting respiration. Again, as suggested with other compounds, EDTA can be used as a chelator to avoid toxic effects of these metals.

Magnesium (Mg)

Magnesium levels in normal seawater have been reported to be 1,272 ppm (Sverdrup *et al.*, 1970), 1,294 ppm (Riley and Chester, 1971) and 1,350 ppm (Spotte, 1970). Fujimura (1989) reported magnesium levels in seawater from Hawaii to be 1,250 ppm and Guam 1,175 ppm. Water samples taken from Fumba, Zanzibar, East Africa (open ocean site) ranged from 837-879 ppm and samples from Bumbwini (a mangrove swamp area on the same island) ranged from 900-940 ppm. See Appendix E, Chapter 1 (Seawater Analyses from other areas of the World and Normal Seawater) for a comparison.

Aluminum (Al)

Spotte (1970) reported that 0.01 ppm aluminum is found as a trace metal in normal seawater. Water samples taken from Fumba, Zanzibar, East Africa contained from 0.76-0.78 ppm aluminum and samples taken from a mangrove swamp area on the same island had a higher level of 1.73 ppm. EDTA could be used as a chelator at the hatchery site (near Fumba, Africa) if this site was ever developed.

Treatment of Heavy Metals

Hopefully the site selected for the hatchery does not involve heavy metals, but if ever faced with the problem then there are several ways to deal with them. Charcoal filtration of water is probably the best treatment, followed by: complexation or chelation of ionic metals by natural substances like humic acids or by synthetic compounds like EDTA. Those substances decrease the metals environmental toxicity through a diminished rate of uptake as compared with the free ion (Holwerda *et al.*, 1988). Trace metals in sea water are mainly associated with chlorides and other inorganic complexes but also may be associated with organic ligands (Engel and Fowler, 1979).

EDTA has been extensively used in the culture media of unicellular algae. Culture assays indicate that both EDTA and EDTA-chelated trace metals intensify the

growth of phytoplankton in sea water (Johnston 1964). Two mechanisms have been proposed for the enhancement of algal growth by EDTA. Johnston (1964) suggested that EDTA increases the solubility and thus the availability of trace metals that are necessary for growth. However, Sunda and Guillard (1976) suggested that the increment on algae growth was due to reduced inhibition by toxic metals which are present in seawater. Several authors have reported decreased heavy metal toxicity on aquatic organisms in the presence of EDTA, and even depuration of accumulated and enhanced regulation of heavy metals. Nugegoda and Rainbow (1988) found that *Palaemon elegans* was clearly able to regulate body zinc at higher external concentrations in the presence of EDTA. A decrease in cadmium concentration in a cadmium-contaminated *Cyprinus carpio* after a short exposure to EDTA was reported by Muramoto (1980). Holwerda *et al.*, (1988) described the cadmium depuration of *Anodonta anatina* exposed to cadmium-EDTA complex. McLeese and Ray (1986) demonstrated that cadmium and copper in chelated form are considerably less toxic to some marine invertebrates. Reduction of the toxicities of cadmium, copper and manganese to *P. stylirostris* larvae are reported in the literature.

EDTA has been proven to improve survival of crustacean larvae exposed to heavy metals by chelating free ions and thus reducing their concentration. Since concentration of heavy metals on natural waters varies over time, routine treatment of these waters by addition of chelating agents could reduce the risk of heavy metal toxicity to a certain extent.

Chelating agents of the Versene family (EDTA and DTPA included) are toxic to fish. Batchelder *et al.*, 1980, and Lawrence, *et al.*, 1981, demonstrated detrimental effects of EDTA to shrimp larvae at concentrations of 0.67 mM and lethal effect at 1.34 mM. Because of these adverse effects, caution in the use of these substances in shrimp hatcheries is recommended. A very narrow range exists between the concentrations needed and the concentrations that produce adverse effects to shrimp larvae. Neither metamorphosis nor survival were affected by EDTA at concentrations of 0.3 mM.

Stability constants of metal-complexation by EDTA are different for each metal (Sillen and Martell, 1971), and while it could keep concentration of free ions of some metals at low levels, for other ions the efficiency of complexation would be lower. This problem might be solved by simultaneous utilization of another chelating agent with large stability constants for the ions, which EDTA has a low affinity for (e.g. DTPA). Further studies are needed in relation to acute and long term toxicities of other chelating agents to cultured shrimp larvae.

More recently Yuan *et al.*, (1992) have described a method of heavy metals removal from larval shrimp rearing systems with polymeric absorbent.

Biological Agents

This section includes a discussion and review of biological agents that are being considered or developed for commercial, agricultural and health purposes as pesticides or biological-control agents. Two major cat-

egories that may influence penaeid shrimp are biochemical agents (arthropod-hormonal agents or their mimics) and infectious-pathogenic agents for arthropods (viruses, bacteria, fungi, protozoa, helminths and parasitods).

To date, there is no strong evidence that any of the above agents are pollutant factors in penaeid shrimp ecology. There is concern, however, for the future use and safety of such agents in coastal regions because of their specific roles in arthropod ecology, physiology and pathology. Biological-control agents must be tested and evaluated regarding their safety for nontarget species such as valuable crustacea and some aquatic insects. The effects of some insect-growth regulators and insect pathogens that are being used or developed as biocontrol agents have been tested in nontarget-crustacean species such as penaeid shrimp or related forms. The results of these studies are reviewed in the following sections.

Biochemical Agents

Naturally-occurring insecticidal chemicals such as pyrethrum, nicotine, rotenone, hellebore, ryania, and sabadilla will not be discussed here because of lack of evidence that they are potential pollutants. Insect-growth regulators, however, have shown promise as synthetic insecticides and have the potential to be used on a wide scale, possibly resulting in environmental exposure of nontarget species. Rotenone is commonly used in ponds to kill fish (by depleting the oxygen).

The major insect-growth regulator that has been tested for effects on crustacea is methoprene. This compound is the only registered (U.S. Environmental Protection Agency) commercially available insect-growth regulator, and is listed as a control agent for flood-water mosquitoes. Persistence of methoprene in the aquatic environment is of short duration (4 to 7 days or less), and does not bioaccumulate. Methoprene is effective in many different insect species but has not shown significant toxicity to nontarget species. The LC₅₀ of methoprene for white and pink shrimp (penaeids) was 100 ppm. Freshwater crayfish also required relatively-high concentrations (LC₅₀ = 100 ppm) for toxic effects to be evident.

There are no reports available on sublethal physiological effects of an insect-growth regulator in penaeid shrimp. How the growth regulators interfere with insects' maturation and reproduction should be examined as possible mechanisms in Crustacea because of the relatively close phylogenetic affinities of Crustacea and Insecta.

Infectious Pathological Agents (Discussed in more detail in the second half of this chapter)

The major group of potential bioinsecticides studied in penaeid shrimp have been the entomopathogenic viruses known as nuclear polyhedrosis viruses (*Baculovirus* group). These insect viruses are of particular interest because related viruses have been found to be natural pathogens in feral and cultured shrimp (Table 7) and in feral crabs.

Discussions concerning the potential relationships between insect baculoviruses (being developed as biological-control agents) and nontarget species from shrimp to humans have been going on since the 1970's. Couch (1979) pointed out the need to better understand the

physical and biochemical nature of these viruses in different host systems. He suggested that new viral insecticides in nontarget crustacean species such as penaeid shrimp (with an emphasis on potentially susceptible larval stages of shrimp) be evaluated and tested frequently. Tests of insect baculoviruses in penaeid shrimp revealed no susceptibility of shrimp for the then-available viral-insecticidal agents. Postlarval, early, and late juvenile stages of brown and white shrimp were inoculated with a free virus and were fed a diet containing a virus. Over a 30-day test period, no mortality attributable to virus exposure occurred in the test shrimp. These types of cross-infection experiments (i.e., insect virus in shrimp) should include careful ultrastructural, biochemical, and genetic monitoring to ensure that sublethal infections establishing the virus in a new host do not occur (Couch, 1979).

In the estuary, the modes of behavior of viral, fungal, bacterial, and protozoan biological-control agents developed as commercial products and for use in coastal agriculture are not known. More needs to be understood about the effects of novel agricultural agents in estuaries, particularly regarding the development of integrated pest-control methods that may utilize combinations of chemical and biological-control agents. Mutagens, in the form of chemicals such as fertilizer components, pesticides, or preservatives, may interact with biological-control agents in ways not presently anticipated, resulting in mutants with expansionist potential. Viruses, bacteria and fungi should be studied to more fully understand this potential problem.

Interactions of Pollutants, Pollutant Mixes and Other Factors in Penaeid Shrimp

Perhaps the most important area for future research in pollution ecology is the study of interactions of specific pollutants and pollutant complexes with physical, chemical and biological factors in the environment. Estuaries are prime examples of multivariate and complex ecosystems where no single variable is altered without influencing some other component of the system. Penaeid shrimp are very dependent upon varying physical, chemical, and biological factors for their survival because of the wide range of factors that they must contend with in their life cycle ranging from the open ocean to the tidal estuary.

Chief among the natural factors influencing penaeid shrimp are salinity, temperature, oxygen concentration (Castille and Lawrence, 1981), bottom types or substrate, nutrition and infectious diseases (Couch, 1978). A severe or sudden perturbation of any of these factors, combined with pollutant stress, may affect total stress or injury in penaeid shrimp. Review of some two-factor interactions follows.

Pollutant-Salinity Stress Interactions

A few reports have been published on the interaction of pollutant and salinity stress in penaeid shrimp. Couch (1979) reports that when brown shrimp were exposed to 3.0 µg/liter of the polychlorinated biphenyl Aroclor 1254 and to a gradual decrease in salinity over an eight-hour period, mortality of exposed shrimp was greater than in

control shrimp exposed to salinity change only or PCB only. The 3.0 µg/liter concentration of PCB was previously found to be sublethal in an eight-hour period. Therefore, the deciding factor that induced mortality was the combination of PCB exposure and salinity change, and that most major ions in the blood of dying shrimp became significantly less as the ambient salinity decreased. However, osmotic pressure overall showed no corresponding loss in the PCB-salinity stressed shrimp, thus complicating any interpretation of physiological mechanism for the lethal effect.

Couch (1979) reported that cadmium, zinc, and lead toxicity was enhanced in marine and estuarine isopods under stressful salinity changes in experimental exposures. Hemolymph osmotic concentrations were altered significantly in isopods exposed to cadmium, zinc and mercury. Since it is known that cadmium destroys the soft-gill tissues of penaeid shrimp, it is probable that the ion and water regulatory mechanism at the epithelial and cell-membrane levels are structurally and functionally affected in crustacea exposed to certain heavy metals. Thus, when salinity changes occur, the osmoregulatory systems of metal-exposed crustacea fail to respond or are inhibited.

Pollutant-Temperature Stress Interactions

Penaeid shrimp have definite upper and lower temperature tolerance limits; they are shrimp of the temperate, subtropic, and tropic zones. Below water temperatures of about (41°-46.4°F), penaeid shrimp become listless and at lower temperatures they die. Above temperatures of (91.4°-95°F) penaeids do not do well. Any pollutant that has a high-oxygen demand would probably, at higher water temperatures in warm months, contribute to lower oxygen tension in water and thus to asphyxiation of penaeids that are sensitive to marginal or low ambient-oxygen concentrations.

Pollutant-Pollutant Interactions

Most specific pollutants enter the estuary as components of complex mixtures of pollutant fallout, runoff or effluents. In many cases estuarine species are exposed to several pollutants at once or to varying concentrations of two or more pollutants. Therefore, it is important to know what the combined and single effects of pollutants may be in estuaries, and the effects of combinations of toxicants in experimentally-exposed shrimp to cadmium-malathion, cadmium-methoxychlor, and cadmium-methoxychlor-Aroclor 1254. The toxicities of the combinations reflected no dramatic interactions when compared to the toxicities of each single component of the mixtures. They stated that the toxicity of each component was independent and additive and no synergism was detected. More studies utilizing a broader range of defined pollutant mixes should be done to more fully explore the possibility of pollutant-pollutant interaction and possible synergism.

Pollutant-Natural Disease Interaction

Pollutant-disease interaction is one of the least-studied phenomena in penaeid shrimp larvae. There are numerous examples in people and other vertebrates of pollutant stress leading to increased susceptibility to natural patho-

gens such as viruses, bacteria, and noninfectious diseases such as neoplasia and respiratory dysfunction. There is growing evidence that some fish diseases are exacerbated by certain pollutants.

Penaeid shrimp have a virus disease caused by a Baculovirus that is exacerbated by a chemical pollutant, Aroclor 1254. This virus-shrimp system has been studied in order to test its suitability as a model-indicator system for determining the degrees of influence that sublethal concentrations of pollutant chemicals may have on a natural-virus host complex. The pink shrimp (*P. duorarum*) has proven to be a natural host for the shrimp-specific Baculovirus originally described as a result of findings made on experimentally-stressed penaeid shrimp. A captive population of pink shrimp with relatively low initial virus prevalence was stressed by 1-3 µg/liter Aroclor 1254 (PCB) for up to 30 days and experienced a significantly more rapid spread and increased prevalence of the Baculovirus than did a control, nonstressed population with equal, initial viral prevalence. The mortality in the Aroclor-Baculovirus-stressed population was greater than that of the Aroclor-stressed population and the control population. At the end of the test, prevalence of viral infections in the Aroclor-stressed population was approximately 50 percent more than in the control population and intensity of individual viral infections was greater in the Aroclor-stressed shrimp.

The ecological implications in these findings suggest a phenomena in nature that to date has not been evaluated. If population immunity or resistance to natural pathogens were reduced in dense populations of Crustacea by sublethal exposures to specific pollutants, then natural disease induced by human-pollutant activity could cause subtle but high mortality over longer periods of time and gradually contribute to an alteration of the ecological balance among certain susceptible species. Aquatic pollution problems have been further discussed by Overstreet (1988), and a symposium on human influences on aquatic ecosystems was held at the 1989 World Aquaculture Society meeting in Los Angeles.

Larval Diseases Overview

(Liao, 1984, plus updates to 1990)

In the initial period of the development of the shrimp industry, unsuitable and insufficient food, which resulted in substandard nutrition and starvation, were major causes of larval mortality. Occasionally, non-lethal or low-mortality diseases caused by protozoan infections occurred, but no serious larval diseases or high mortality were encountered. In contrast, since penaeid culture has become popular and profitable in recent years, hatcheries are often overcrowded with larvae and this is generally accompanied by the occurrence of diseases. White-turbid midgut gland disease was reported in *P. japonicus* (Shigueno, 1985), as well as *Lagenidium* infection in all penaeids (Couch, 1942; Cook, 1971; Lightner and Fontaine, 1973; Lightner 1977; Lightner and Redman, 1981; Lightner, 1983a).

Baculovirus penaei (BP) disease in *P. aztecus*, *P. duorarum*, *P. setiferus*, *P. stylirostris*, *P. subtilis*, and *P. vannamei* (Couch

1974a, 1974b; Laramore, 1977; Couch, 1978; Overstreet, 1978, Bueno, *et al.*, 1989), and also baculoviral midgut gland necrosis (BMN) in *P. japonicus* (Sano *et al.*, 1981); *Monodon baculovirus* (MBV) disease in *P. monodon* (Lightner and Redman, 1981; Lightner, 1983a; Chen and Kou, 1989); infectious hypodermal and hematopoietic necrosis (IHHNV) in *P. stylirostris*, *P. monodon* (Lightner, 1983a), and more recently in the late 1980's has been found to cause problems in *P. vannamei*; hepatopancreatic parvovirus (HPV) recognized in cultured *P. merguensis* (Lightner and Redman, 1985) and in *P. chinensis*, *P. semisulcatus*, *P. esculentus* and *P. monodon*; a reo-like virus, in *P. japonicus* (Tsing and Bonami, 1987) in *P. monodon* (Nash *et al.*, 1988); and lastly *Plebejus baculovirus* in *P. plebejus* (Lester *et al.*, 1987); have all proven to be a serious threat to the shrimp-culture industry. Table 7 (modified from Liao 1984 with updates to 1990) summarizes the major diseases in the larval and postlarval stages of penaeids and the corresponding treatments. The geographic ranges of these viruses are also increasing and have been addressed by Lightner and Redman, in press; Lightner *et al.*, 1988; Lightner, Redman and Ruiz, 1988; and Lightner *et al.*, in press.

It is becoming evident that diseases are increasing in variety and frequency, especially with respect to the virus-caused diseases. At the present (1992), about eight viral diseases have been identified (six different types) in penaeid larvae. The ultimate concern is obviously for the prevention of diseases and how to reduce the devastating effect on larvae so that great losses can be avoided. MBV disease shows its lethal effect only when combined with the serious symptoms of other diseases. It is true that by providing MBV-infected larvae with a suitable environment and food they are better protected from other diseases and can attain normal growth. MBV is known to exist in Taiwan, Indonesia, The Philippines, Hawaii, China, Malaysia, Singapore, Australia, South Africa, Israel, Kuwait, Italy, Tahiti, Mexico, Ecuador, Brazil and Texas, but the extent of its range in other areas is unknown. Being an enzootic virus, MBV can and should be eradicated. To avoid further spreading, strict quarantines and burning of the infected larvae should be carried out (Lightner *et al.*, 1983a). Apparently, it was introduced into the Pacific and The Americas (Lightner, *et al.*, in press) by imported larvae.

The concept that prevention is more important and effective than cure in controlling a disease is absolutely accurate. Reducing stress due to over-crowding and executing properly-operated quarantines are as necessary as continuing research on viruses and determining the etiology of other diseases.

General knowledge of what a normal shrimp looks like can be obtained by consulting Bell and Lightner (1988). If the shrimp appear to have a disease, it is recommended that the disease be identified by microscopic examination and compared to one of the publications that have figures or photographs of the diseases (such as Johnson's *Handbook of Shrimp Diseases*, Texas Sea Grant Program 1989, or Lightner's *Diseases of Cultured Penaeid Shrimp*, CRC, 1983). After the disease is identified, either Lightner's recommended treatment or one of the treatments listed

Table 7. Diseases Found in the Developmental Stages of Penaeid Larvae and Their Control Methods (List from Liao, 1984, plus updates to 1990).

Disease	Affected Parts	Symptoms	Treatment	Life Stages Affected*	References
Bacteria					
Bacterial necrosis	Appendages	Appearing as localized necrosis or discoloration on any appendage, causing high mortality of zoea and mysis stages, affects post-larva to a lesser extent.	Furnace Erythromycin Achromycin	1.1 ppm 1.5 ppm 1.2 ppm	Z1 M1 PL Tareen, 1982 Lightner, 1983
Vibrio infection	Hemolymph, midgut gland	Initial stages of one form, some larvae will show yellow-vermillion and red color permeating entire nervous system. Another form exhibits "White-turbid liver", where the midgut gland of the larvae becomes generally white-turbid. Turbidity becomes more apparent and well-defined as the disease progresses.	Furazolidone Teramycin Furnace	2.0 ppm 450 mg/kg biomass 1.3 ppm	PL Nickelson and Vanderzant, 1971 Lewis, 1973 Shigueno, 1975 Lightner, 1977 Johnson, 1978 Cipriani, et al. 1980
Filamentous bacteria	Gills, pleopods	Commonly found attached to the gill filaments and the pleopods, turning blackish when bacteria mix with dirt. If severely affected, the respiratory function of the gill suffers damage.	Citrine plus Malachite green Potassium permanganate Cuprous chloride	0.5 ppm 10ppm 8.5 ppm 1.0 ppm	PL Delves-Broughton and Poupard, 1976 Streenbergen and Schapiro, 1976. Johnson, 1978 Solangi, et al., 1979 Tareen, 1982 Lightner, 1983
Shell disease	Exoskeleton, muscles	If infected by chitinoverous bacteria, the exoskeleton will display eroded blackened areas. Also bacteria can rapidly enter the body through surface breaks to cause internal damage.	Malachite green and Formalin combined	0.9 ppm 22 ppm	PL Cook, 1973 Delves-Broughton and Poupard, 1976 Johnson, 1978 Tareen, 1982 Lightner, 1983
Black gill disease	Gills	In initial stages, gill color turns dull orange-yellow or light brown, when advanced, the area darkens until it is finally black.	Malachite green Methylene blue	3.0 ppm 8-10 ppm	PL Shigueno, 1975 Tareen, 1982
Fungi					
Lagenidium infection	Body cavity, appendages	Only thin-cuticled shrimp can be infected thus larval shrimp are highly sensitive. The hyphae appear inside the body of zoea and continue into mysis stage, resulting in massive muscle destruction and heavy mortality of zoea and mysis.	Treflan® Malachite green	0.1 ppm 0.01 ppm	Z1 Hubschaman and Schmitt, 1969 Lightner and Fontaine, 1973. Lightner, 1977 Johnson, 1978 Gopalan et al., 1980 Tareen, 1982 Lightner, 1983

Table 7. Diseases Found in Development Stages of Penaeid Larvae and Their Control Methods (continued).

Disease	Affected Parts	Symptoms	Treatment	Life Stages Affected*	References	
Ectocommensal protozoa						
Ciliate infection (<i>Zoothamnium</i> sp. <i>Epistylis</i> sp.)	Gills, eyes Exoskeleton	Heavy infestation by <i>Zoothamnium</i> sp. on gills and eyes of larval shrimp results in high mortality. <i>Epistylis</i> sp. seems to prefer exoskeleton as attachment site and is less harmful. When abundant on gill surface, both can cause hypoxia and death. Additionally, their abundant presence on general body surface of larvae may interfere with locomotion, feeding, molting, etc. Parasite burden increases until ecdysis provides relief.	Malachite green and Formalin combined Quinacrine hydrochloride Chloramine-Methylene blue Saponin 10%	1.0 ppm 25 ppm 0.8 ppm 5.5 ppm 8.0 ppm 5.0 ppm	Z M, PL	Johnson, et al., 1973 Overstreet, 1973 Delves-Broughton and Poupard, 1976 Lightner, 1977 Liao, et al., 1977 Johnson, 1978 Lightner, et al., 1980 Tareen, 1982 Lightner, 1983
Viruses						
Penaeid baculoviruses (BP, MBV, BMN)	Hepatopancreas, Anterior midgut	Penaeid baculoviruses infect epithelial cells of the hepatopancreas and, less commonly, anterior midgut, causing high mortality in the post-larval stage.			PL	Johnson, 1978 Sano, et al., 1981, 1984, 1985 Lightner, 1983, 1987, 1988 Lightner & Redman, 1981 Lightner, et al., 1983c, 1988, 1990 Couch, 1974a Lester et al., 1987 Momoyama, 1983 Overstreet, et al., 1988 Chen & Kou, 1989 Bueno, et al., 1989
Infectious hypodermal and hematopoietic necrosis (IHNN)	Hypodermis, Hematopoietic organs	Shrimp dying from acute IHNN show massive destruction of cuticular hypodermis and often of the hematopoietic organs, of glial cells in the nerve cord, and of loose connective tissues such as the subcutis and gut serosa. Only shrimp within a size range of 0.005-1.0 g have been observed to have these epizootics, resulting in massive mortalities (often 80 to 90% within 2 weeks) of onset)			PL	Lightner, 1983a, 1987, 1988 Lightner & Bell, 1987 Lightner et al., 1983a, 1983b, 1983d, 1985, 1990 Brock et al., 1983 Bell & Lightner, 1983, 1987
Hepatopancreatic Parvovirus-like virus (HPV)	Hepatopancreas	Nonspecific signs including poor growth rate, anorexia, reduced preening activity, increased surface fouling, and occasional opacity of tail muscle.			Larvae may be infected but does not show up until juvenile stage.	Lightner & Redman, 1985 Paynter et al., 1985 Colorni et al., 1987 Chong & Loh, 1984 Tsing & Bonami, 1987 Nash et al., 1988 Nash & Nash "in press".
Reo-like virus (REO)	Hepatopancreas (R-cells)	Found in <i>P. japonicus</i> and <i>P. monodon</i> thus far.				
Miscellaneous Diseases						
Abnormal nauplii	Appendages	Occurs as a result of poor quality of spawner.			N	Tareen, 1982
Amoebiasis of larvae	Subcutis, muscle	Invasion of muscles and subcuticular tissues located in the abdomen, cephalothorax, antenna, and eye stalks, by unclassified amoeba.			Z	Laramore and Barkate, 1979 Lightner, 1983
Larval encrusta-	Exoskeleton	Brown to black encrusted deposits which contained iron salts affect larval penaeids			Z, M, PL	Lightner, 1983

*N=nauplius, Z=zoea, M=Mysis, PL=post-larva

here can be used. Details of the current diagnostic procedures for the viral diseases of penaeids have been recently published elsewhere (Lightner, 1988 and Lightner and Redman, in press). For a more general background on the pathology of animals in the marine aquaculture industry, consult *The Fish Health Blue Book* (published by the Fish Health Section of the American Fisheries Society; Amos, 1985); "Disease Diagnosis and Control in North American Marine Aquaculture" (Sindermann and Lightner, 1988); "Synopsis of Invertebrate Pathology Exclusive of Insects" (Spark, 1985); and *Control of the Spread of Major Communicable Fish Diseases* (FAO, 1977).

Larval and Juvenile Shrimp Diseases Detail (Lightner 1984; updated to 1990)

In most semi-intensive and intensive-culture systems, recognition, prevention, and treatment of disease is possible. Whereas, in intensive and many semi-intensive culture systems, treatment of disease is impractical even if they are diagnosed. Furthermore, except for certain types of parasitic diseases, it is the very nature of intensive and semi-intensive culture systems (i.e., high shrimp density per unit volume of water used) that encourages the development and transmission of many shrimp diseases. The same economic incentives for using semi-intensive and intensive-culture systems dictate that disease can be understood and controlled.

Infectious Diseases

Viral Diseases — Knowledge of the diseases of the penaeid shrimp have been reviewed a number of times within the past 16 years (Overstreet, 1973 and 1982; Sano and Fukuda, 1987; Sindermann, 1974 and 1988; Sindermann and Lightner, 1988; Johnson, 1975, 1978, 1989; Couch, 1978; Lightner, 1977, 1983, 1984 and 1989; Lightner *et al.*, 1987; Liao, 1984). This section includes recent developments and discoveries in shrimp pathology through mid-1990.

A number of viral diseases of cultured penaeids have been reported (Table 8) and several additional diseases have been noted to be associated with the virus-like or chlamydial-like structures. Included among the documented viruses causing disease in penaeids are: *Baculovirus penaei* or BP (Couch 1974a), baculoviral midgut gland necrosis or BMN (Sano *et al.*, 1981), and *Monodon baculovirus* or MBV (Chen and Kou, 1989; Lightner and Redman 1981); the probable picornavirus infectious hypodermal and hematopoietic necrosis virus or IHNV (Lightner *et al.*, 1983 and 1987); the small DNA-containing virus named hepatopancreatic parvo-like virus or HPV (Lightner and Redman, 1985); a reo-like virus in the hepatopancreas of *P. japonicus* (Tsing and Bonami, 1984), a reo-like virus in *P. monodon* (Nash *et al.*, 1988) and *Plebejus baculovirus* in *P. plebejus* (Lester *et al.*, 1987).

Baculoviruses — The known penaeid baculoviruses infect the epithelial cells of the hepatopancreas of protozoal-through-adult life stages and the midgut epithelium of larvae and postlarvae. Baculovirus infections may result in disease in cultured penaeids that is accompanied by high-mortality rates. In hatcheries BP and BMN often cause serious epizootic disease outbreaks in the

larval and early postlarval stages of their principal host species (Table 8) (Couch 1981; Sano *et al.*, 1981), and BP may cause disease and mortalities in juvenile and sub-adult animals (Couch 1981). Epizootic disease outbreaks due to MBV in hatchery-reared *P. monodon* are known to occur from late postlarval (PL 25 to PL 50) through the juvenile and adult-life stages, although the most serious losses have been observed in the late-postlarval stages (Lightner *et al.*, 1983).

The geographic distribution of these baculoviruses in cultured penaeid shrimp suggests that they are problems to shrimp culturists only in those areas where the virus is enzootic in local wild populations. This appears to be the case of BMN, which has thus far been observed in *P. japonicus* in hatcheries in Japan. However, MBV and BP have been documented as having been introduced into new geographic regions by the transfer of infected postlarvae or broodstock to areas outside the normal range of the host species. According to Lightner *et al.*, in press, BP is widely distributed in cultured and wild penaeids in the Americas. BP has not yet been observed in wild, cultured or imported (from the Americas) penaeid shrimp outside of the Americas. New information on the host and geographic distribution of BP has come from Brazil, Ecuador and Mexico. In Brazil and Ecuador, BP infects larvae and postlarvae of six penaeid species. It is significant that the imported Asian species *P. monodon* and *P. penicillatus* were also found to be infected. BP was found in Mexico in cultured larval and postlarval *P. stylirostris* at a facility near Guaymas, Sonora on the West Coast of Mexico (Lightner *et al.*, 1988).

Patent acute BP and MBV infections may be readily diagnosed by demonstration of their characteristic occlusion bodies in either wet-mounts or histological preparations of the hepatopancreas and midgut (Lightner 1983; Lightner *et al.*, 1989; Bonami *et al.*, 1986). BP occlusions are distinctive tetrahedral bodies easily detected by bright field or phase microscopy in unstained wet-mounts of tissue squashes, while MBV occlusions are spherical and therefore difficult to distinguish from lipid droplets, secretory granules, etc. The use of a stain like 0.1 percent aqueous malachite green in preparing wet-mounts for MBV diagnosis aids in demonstration of the occlusions. Presumably, the protein making up the occlusion absorbs the stain more rapidly than does most of the host-tissue components, making them distinct within a few minutes. BP and MBV occlusion bodies in histological preparations appear as prominent eosinophilic, usually multiple occlusion bodies, within the hyper-trophied nuclei of hepatopancreatic tubule or midgut-epithelial cells.

Unlike BP and MBV, which are Type-A baculoviruses because they produce occlusion bodies, BMN is a Type-C baculovirus that does not produce an occlusion body. Hence, diagnosis of BMN infections is dependent upon the clinical signs of the disease, histopathology and transmission electron microscopic (TEM) demonstration of the baculovirus in affected hepatopancreatocytes (Lightner *et al.*, 1984). Sano *et al.*, (1983), developed a rapid fluorescent antibody test for BMN that reportedly simplifies the diagnosis of BMN.

The cytopathology of BP, MBV, and BMN is generally

Table 8. The Penaeid Viruses and Their Known Natural and Experimentally Infected Hosts (Lightner *et al.*, 1985, plus updates to 1990).

Host Subgenus and Species**	Virus*					
	BP	MBV	BMN	IHHNV	HPV	REO
Litopenaeus:						
<i>P. vannamei</i>	+++	+		+	+	
<i>P. stylirostris</i>	++			+++		
<i>P. setiferus</i>	+			+(@)		
<i>P. schmitti</i>	++					
Penaeus:						
<i>P. monodon</i>	+	++		++	++	++
<i>P. esculentus</i>		+			++	
<i>P. semisulcatus</i>		+	+		+++	
Fenneropenaeus:						
<i>P. merguensis</i>		++			+++	
<i>P. indicus</i>					+	
<i>P. chinensis</i> (= <i>orientalis</i>)					++	
<i>P. penicillatus</i>	++	++			++	
Marsupenaeus						
<i>P. japonicus</i>			+++	++(@)		+++
<i>P. plebejus</i>		++				
Farfantapenaeus						
<i>P. aztecus</i>	+++			+(@)		
<i>P. duorarum</i>	+++			+(@)		
<i>P. brasiliensis</i>	++					
<i>P. paulensis</i>	++					
<i>P. subtilis</i>	++					
Melicertus:						
<i>P. kerathrus</i>		+				
<i>P. marginatus</i>	+++					
<i>P. plebejus</i>		++				
*Abbreviations:						
BP	= <i>Baculovirus penaei</i>					
MBV	= <i>P. monodon baculovirus</i>					
BMN	= Baculoviral midgut gland necrosis					
IHHN	= Infectious hypodermal and hematopoietic necrosis					
HPV	= Enteric parvo-like virus					
RBO	= Reo-like virus					
+	= Infection observed in species, but without signs of disease.					
++	= Infection may result in moderate disease and mortalities.					
+++	= Infection usually results in serious epizootic disease outbreaks with high mortality rate.					
@	= Experimentally infected; natural infections not yet observed.					
**	= Classification according to Holthuis, 1980, FAO Species Catalog.					

similar when studied by light microscopy, differing principally by the lack of occlusion bodies in BMN. Often the affected hepatopancreatocyte nuclei have a peripherally displaced compressed nucleolus and a marginated chromatin, giving affected nuclei a "signet ring" appearance, even before occlusion bodies become well developed. Brown and Brenn histologic gram stain (Luna, 1968), although not specific for baculovirus occlusion bodies, tends to stain occlusion more intensely than the surrounding tissue, aiding in identifying their presence in low-grade infections.

A TEM test of BP and MBV-infected cells showed large numbers of rod-shaped baculovirus particles both free and occluded within the proteinaceous crystalline matrix of the occlusion body, but only free virus in the nuclei of BMN-infected hepatopancreatocytes.

A more recent baculovirus (*Plebejus baculovirus*) has been reported in *P. plebejus* (Lester *et al.*, 1987). Also Akamine and Moores (1989 WAS meeting) described a spray method, using sodium hydroxide to disinfect shrimp hatcheries infested with *Baculovirus penaei*.

BP is widely distributed in cultured and wild penaeids

in the Americas, ranging from the Northern Gulf of Mexico south through the Caribbean and reaching at least as far as the state of Bahia in Central Brazil. On the Pacific Coast, BP ranges from Peru to Mexico, and it has been observed in wild penaeid shrimp in Hawaii (Lightner *et al.*, in press).

IHHN Virus — This probable picornavirus, named IHHNV for infectious hypodermal and hematopoietic necrosis virus, was first recognized in 1981 in Hawaii in populations of cultured *P. stylirostris* that had been imported from a number of commercial penaeid hatcheries (Lightner *et al.*, 1983a). Since its discovery in *P. stylirostris*, IHHNV has been found to infect a variety of other penaeid species either in natural infections or in experimentally-induced infections (Table 8).

IHHNV causes serious epizootic disease outbreaks in intensively or semi-intensively reared *P. stylirostris*, with accumulative mortalities typically exceeding 90 percent of the affected populations within 14 to 21 days of onset in 0.05 to 2 g juveniles (Lightner *et al.*, 1983a). IHHNV has also been documented to cause disease and serious epizootic disease outbreaks in larger juvenile and adult *P. stylirostris* (Lightner and Bell, 1987) and in juvenile and adult *P. monodon* reared in intensive or semi-intensive culture systems (Brock *et al.*, 1983). IHHNV has been shown to infect and to be carried asymptotically by *P. vannamei* (Lightner *et al.*, 1983a; Bell and Lightner 1984). Further study of IHHNV disease in *P. vannamei* may show that under stressful culture conditions some mortality losses and/or reduced-growth rates may occur.

IHHNV has been detected in penaeid shrimp sampled from a number of shrimp-culture facilities located in widely separated geographic locations (Bell and Lightner, 1983 and Lightner *et al.*, in press). This suggests that IHHNV has become widely distributed in penaeid culture facilities (Bell and Lightner, 1987 and Lightner *et al.*, in press) probably as a result of the difficulty of detecting viral infection in asymptomatic carrier hosts such as *P. vannamei* or because losses due to the virus in pond-reared stocks are difficult to detect. IHHNV is a disease of juvenile or older shrimp; apparently it does not adversely affect the larval or postlarval stages and therefore IHHNV does not occur in hatcheries where it would be readily detected. Instead, IHHNV produces its most serious epizootic outbreaks in *P. stylirostris*, *P. vannamei* and in *P. monodon* shrimp of 0.05 g to 2 g, the size when shrimp typically have been moved to nursery or grow-out ponds. Water turbidity and the shrimp's small size at this time in the life cycle makes detection of the disease in intensive and semi-intensive culture systems difficult. Control of the disease is further complicated by the fact that penaeid shrimp surviving IHHNV infections become carriers of the virus for life and pass the virus on to their offspring (Lightner *et al.*, 1983a).

Diagnosis of infection by IHHNV is dependent upon histological demonstration of prominent eosinophilic, Fielgen-negative intranuclear inclusion bodies within chromatin-margined, hypertrophied nuclei of cells in tissues of ectodermal (epidermis, hypodermal epithelium of foregut and hindgut, nerve cord, and nerve ganglia) and mesodermal origin (hematopoietic organs, antennal gland tubule epithelium, mandibular organ, connective

tissue, and striated muscle). Usually the midgut, midgut caeca and the hepatopancreas (endoderm-derived tissues) are unaffected, except in severe cases where hepatopancreatic involvement has been observed. These inclusion bodies were described by Cowdry (1934). Basophilic chromatin strands are occasionally visible by light microscopy within IHHNV intranuclear inclusion bodies. These chromatin strands are a prominent feature of IHHNV intranuclear inclusion bodies shown by a TEM test. IHHNV intranuclear inclusion bodies are common early in acute infections, later decreasing in number, and are followed by necrosis and inflammation of target tissues. Affected cells may also have highly vacuolated cytoplasm and small cytoplasmic basophilic inclusions. Although the prominent intranuclear inclusions present in shrimp infected with IHHNV are evidence of nuclear involvement, assembly of the virus occurs in the cytoplasm of affected cells. The size of the virus (17 to 26 nm in tissue sections and 20 to 22 nm in purified preparations), its morphology, and its replication within the cytoplasm support the tentative classification of IHHNV with the picornaviruses.

Since 1985, no new hosts for IHHNV have been demonstrated. However, the geographic distribution of the virus in culture facilities has continued to expand.

HPV — This probable parvovirus named HPV, or hepatopancreatic parvo-like virus, was first recognized in cultured *P. merguensis* in Singapore and Malaysia in 1983 (Lightner and Redman, 1985). HPV (or a very similar agent) was subsequently recognized in four additional penaeid species (*P. chinensis*, *P. semisulcatus*, *P. esculentus* and presumed *P. monodon*) in either captive wild populations or in cultured populations. Individual shrimp with HPV displayed nonspecific signs including poor growth rate, anorexia, reduced preening activity, increased surface fouling, and occasional opacity of tail musculature. Mortalities accompanied by these signs occurred during the juvenile stages, after apparently normal development through the larval and postlarval stages. The accumulative mortality rate in HPV epizootic outbreaks in *P. merguensis* and *P. semisulcatus* reached as high as 50 percent to 100 percent, respectively, of the affected populations within four to eight weeks of disease onset.

The principal lesion in HPV disease, common to all affected species, is a necrosis and atrophy of the hepatopancreas, accompanied by the presence of large prominent basophilic, PAS-negative, Fielgen-positive intranuclear inclusion bodies in affected hepatopancreatocytes. These inclusion bodies are diagnostic for HPV, and presumably develop from small eosinophilic intranuclear bodies that are also present in the affected tissues. Electron microscopy of affected hepatopancreatocytes revealed aggregations of 22 to 24 nm diameter particles within the electron-dense granular inclusion-body ground substance. The virus-like particle size and morphology, the close association of the nucleolus with the developing inclusion body, and the presence of intranuclear bodies within developing inclusion bodies are similar to cytopathological features reported for parvovirus infections in insects and vertebrates.

HPV has a geographic range in Asia and Australia similar to that of MBV, and like MBV it has been intro-

duced to the Americas with imported penaeids. More recently, HPV was found for the first time in dual infections with MBV. It was found in postlarval and juvenile *P. monodon* sampled from farms in the Ping Tung area of Taiwan. In 1987 this region experienced serious disease losses, and HPV is suspected as being a contributor to the 1987 epizootic disease outbreak. The geographic distribution and known hosts of this virus have expanded. Paynter *et al.*, 1985 reported the virus in *P. esculentus* from Australia; it has been found in *P. monodon* imported to Israel from Kenya (Colorni *et al.*, 1987) and lastly it was found in captive-wild and hatchery-reared *P. indicus* and *P. merguensis* in Singapore (Chong and Loh, 1984). HPV has been observed in the Americas, mainly Brazil and Ecuador (Lightner *et al.*, in press).

Reo-like Virus — A reo-like virus was present in large, vital areas in the cytoplasm of hepatopancreatic R-cells of diseased laboratory-reared *P. japonicus* from the Mediterranean city of Palavas in France (Tsing and Bonami, 1987). Purified virions were non-enveloped, icosahedral particles of about 60 nm in diameter. The disease was reproduced in healthy *P. japonicus* by inoculation with purified virus and by feeding animals pieces of the hepatopancreas from infected shrimp. Disease developed slowly in animals exposed to the reo-like virus, requiring about 45 days to develop. Secondary infections by agents such as *F. solani* were common in reo-like virus-infected *P. japonicus* (Tsing and Bonami 1987). Reo-like virus has also been found in *P. monodon* (Nash *et al.*, 1988 and Nash and Nash, in press).

General Procedures for Virus Screening

The following three diagnostic procedures have been developed for screening penaeid shrimp for viral infections:

- Direct samplings for microscopic (wet-mount) examination and/or histopathology.
- Enhancement of infection followed by microscopic examination and/or histopathology.
- Bioassay of a suspected shrimp population with a sensitive indicator species followed by sampling and histopathology (Lightner *et al.*, 1983a).

In the direct sampling procedure, nonrandom samples of shrimp are selected from culture tanks, ponds, or cages and examined directly for signs of BP or MBV in wet-mounts, or they may be preserved in Davidson's Alcohol Formalin Acetic Acid (AFA) or 10 percent buffered formalin (Humason, 1967) for histological evaluation. The sensitivity of this procedure is limited and it will only demonstrate shrimp with viral infections that are acute or subacute in a population with a high-incidence rate. IHHNV, BP, MBV, and HPV have been diagnosed with direct samples, but such samples have also produced false-negative diagnoses on populations later shown on enhancement or bioassay diagnostic procedures to be positive for one of these viral diseases (Lightner *et al.*, 1985).

In the enhancement procedure, a quarantined population, is reared under relatively crowded and stressful conditions. Postlarvae are best used for this test, which usually requires 30 to 60 days to complete. Random samples are taken at intervals throughout the test period, or nonrandom samples are selected as moribund animals are ob-

served. Samples may be prepared for wet-mount microscopic examination for BP and MBV, or preserved for histological evaluation. The enhancement procedure is far more sensitive than the direct sampling procedure for BP- and MBV-caused diseases, and for IHHN disease in *P. stylirostris* (Lightner *et al.*, 1987). Paynter *et al.*, (1984), found that diagnosis of HPV in captive wild *P. esculentus* in Australia may also lend itself to the enhancement procedure. Enhancement is not a suitable procedure for demonstration of IHHNV in asymptomatic carriers. For example, the enhancement procedure will not readily demonstrate IHHNV to be present in subadult or adult *P. stylirostris* that are IHHNV epizootic disease survivors, or in species such as *P. vannamei* that are readily infected by the virus but seldom show diagnosable infections (Lightner *et al.*, 1983a).

In the bioassay procedure, carriers of IHHNV may be detected by sensitive "indicator" shrimp. Indicator shrimp in this procedure (known IHHNV-free juvenile *P. stylirostris* of 0.05g to 4g body weight) may be exposed to samples of suspected carrier shrimp by one or more of the following three methods:

- Injection with a cell-free filtrate prepared from a homogenate of suspected carrier shrimp (the indicator shrimp will show signs of IHHNV disease within 5 to 15 days if the suspected shrimp were infected with IHHNV).
- Rearing suspected carrier shrimp with indicator shrimp in the same tank (the indicator shrimp will show signs of IHHNV disease within 15 to 60 days).
- Feeding chopped carcasses of suspected carrier shrimp to indicator shrimp (the indicator shrimp will show signs of IHHNV within 15 to 60 days). (Lightner *et al.*, 1983a).

Actual diagnosis of infection by BP, MBV, BMN, HPV, and IHHNV is dependent on microscopic or histologic demonstration of the particular cytopathology that is unique to each disease. Gross signs and behavior are usually not sufficiently specific in shrimp infected by these penaeid viruses to be reliably used in diagnosing these diseases. Also see methods for routine virological examinations, (Johnson, 1989) discussed later in this chapter.

Rickettsia — Rickettsia infections have been reported to cause shrimp disease (Brock *et al.*, 1986; Brock, 1988; and Colorni *et al.*, 1987). Rickettsia are microbes that are similar to both viruses and bacteria and have a size that is normally somewhere in between the two. Cells of the digestive gland are damaged from Rickettsia microbes.

Bacterial and Fungal Diseases

Bacteria — A number of bacteria have been implicated as causes of disease and mortality in cultured penaeids, especially in the larval, postlarval and juvenile stages (Johnson, 1978 and 1989; Lightner, 1983). Bacterial infections in shrimp take three general forms: erosions of the cuticle covering the general body surface, gills, and appendages (bacterial necrosis and shell disease), localized lesions within the body, and generalized septicemias. Reports on the occurrence of bacterial diseases in cultured penaeids in Kuwait (Tareen, 1982), and China (Meng and

Summary of Penaeid Viruses in the Americas and Their Status as of 1990

(From Lightner *et al.*, in press)

Virus	Status in the Americas and Hawaii
IHHNV	Widely distributed in cultured <i>P. vannamei</i> and <i>P. stylirostris</i> ; not recognized in wild penaeids; enzootic in Southeast Asian wild penaeids; recently introduced into Western Mexico from Texas and Panama with postlarval <i>P. vannamei</i> .
HPV	Enzootic in Asia, Australia, and Africa; introduced to one or more sites in South America from Taiwan; can infect the American penaeid <i>P. vannamei</i> .
BP	Widely distributed in American penaeids; enzootic in wild penaeids on both Atlantic and Pacific sides of tropical and subtropical America.
MBV	Enzootic in Asia, Australia, Africa, and the Mediterranean; introduced to several sites in Hawaii, North, Central, and South America; can infect <i>P. vannamei</i> ; contaminated stocks eradicated from Hawaii, Mexico, and Texas.
BMN	Enzootic in Japan; not reported outside of Japan.
REO	Enzootic in Japan; introduced to Hawaii from Japan; contaminated stocks eradicated in Hawaii.

Observed and Reported Occurrences of the Penaeid Viruses in Wild and Cultured Penaeids Indicating Their Probable Natural and Introduced Geographic Distributions

(From Lightner *et al.*, in press)

Virus	Region/site where found	Host Status*	Virus Status
IHHNV	Atlantic side: SE U.S. Caribbean, and Brazil	Cul	introduced
	Pacific side: Ecuador, Peru, and Central America	Cul	introduced?
	Pacific: Hawaii, Guam, Tahiti	Cul	introduced
	Asia: Taiwan	Cul	introduced
	Singapore, Malaysia and Philippines	CW	enzootic?
	Middle East: Israel	Cul	introduced
HPV	IndoPacific: P.R. China, Taiwan, Philippines, Malaysia, Singapore and Australia	Cul, CW, W	enzootic
	Africa: Kenya	W	enzootic
	Middle East: Israel and Kuwait	Cul, CW	enzootic
	Americas: Brazil, Ecuador	Cul	introduced
BP	Atlantic side: SE U.S., Caribbean and Brazil	Cul, CW	enzootic
	Pacific side: Ecuador, Peru and Central America	Cul, CW, W	enzootic
	Mexico	Cul, CW	enzootic
	Hawaii	W	enzootic
MBV	IndoPacific: P.R. China, Malaysia, Singapore and Australia	Cul, CW, W	enzootic
	Africa: S. Africa	W	enzootic
	Middle East: Israel and Kuwait	Cul, CW, W	enzootic
	Mediterranean: Italy	Cul, CW, W	enzootic
	Pacific: Tahiti, Hawaii	Cul	introduced
	Americas: Mexico, Ecuador, Texas and Brazil	Cul	introduced
BMN	Japan	Cul, CW, W	enzootic
REO	Japan, Malaysia	Cul	enzootic
	Hawaii and France	Cul	introduced

- * Cul = "cultured;" from cultured or captive-wild broodstock.
 CW = "captive-wild;" from wild-caught seed or from single-spawn wild broodstock
 W = wild population.

Yu, 1980, 1982, 1983) are similar to previously reviewed reports from other shrimp-culture groups (Lightner, 1977, 1983). While bacterial diseases of a probable primary-bacterial etiology have been reported in penaeid shrimp (Nickelson and Vanderzant, 1971; Cook and Lofton, 1973), the majority are of a secondary etiology, occurring as a result of syndromes due to such things as ascorbic-acid deficiency, toxins, wounds, extreme stress, etc. (Lightner, 1983). A number of reports in literature support this observation. Many laboratory attempts have been made to complete Koch's postulates with bacterial isolates obtained from penaeids, and in each study a relatively massive inoculum had to be administered to overcome the natural defenses of the host and to produce disease and death in the experimental animals (Vanderzant *et al.*, 1970; Lewis, 1973, Lightner and Lewis, 1975; Corliss *et al.*, 1977; Huang *et al.*, 1981). One study showed that cell-free solutions of crude extracts of endotoxins and exotoxins of *Vibrio parahaemolyticus* and *V. alginolyticus* injected into *P. setiferus* produced significant mortalities with gross signs similar to those observed in actual bacterial infections (Leong and Hanrahan, 1980).

In every reported bacterial infection in penaeid shrimp, motile, gram-negative, oxidase-positive, fermentative rods have been isolated from lesions or host hemolymph. Most isolates have been *Vibrio* spp., usually *V. alginolyticus*, *V. parahaemolyticus*, or *V. anguillarum*. Certain other gram-negative rods, including *Pseudomonas* spp., and *Aeromonas* spp. may occasionally be involved in bacterial-disease syndromes in penaeid shrimp (Lightner, 1983). All of these genera and species have been reported to be among the normal microflora of penaeids (Vanderzant *et al.*, 1970, 1971; Hood and Meyers, 1977; Yasuda and Kitao, 1980; Lewis *et al.*, 1982). Although a variety of gram-positive cocci, including the etiological agent (*Aerococcus viridans*) that causes highly lethal Gaffkemia disease in *Homarus* lobsters have been isolated from shrimp, none have been linked with disease in penaeids (Stewart and Rabin, 1970; Vanderzant *et al.*, 1971; Vanderzant *et al.*, 1972). Hence, it would appear that shrimp have only opportunistic pathogens that are part of their normal microflora. A possible exception to this was the discovery of a gram-negative, acid-fast rod causing disease in adult *P. vannamei* (Lightner, unpublished). Shrimp infected with this microorganism were moribund when collected, but showed no externally apparent abnormalities. Histopathology, however, revealed that the acid-fast bacterium was present in very large numbers either encapsulated in melanized hemocyte nodules or in the tissues surrounding such granulomatous lesions in the host hepatopancreas, antennal gland, and mandibular organ. Additional sources of bacterial contamination in penaeid shrimp hatcheries are discussed by Hasson (1987) and Chen *et al.*, in press.

Fluorescent Bacteria

According to Duremdez and Lio-Po, SEAFDEC Asian Aquaculture Vol. X, No. 2 page 9, June 1988, "Pseudomonas fluorescens is a gram-negative, rod-shaped bacterial species with flagellar filaments for active motility. It produces greenish to yellowish diffusible pigments on selective agar medium such as Pseudosed Agar Growth and

viability of this bacterium is maintained in optimum freshwater conditions for more than 150 days while viability in brackish-water situations is limited to only 50 days. Seawater medium is not tolerated by this bacterium. This species is thus able to survive and thrive only in freshwater and brackish-water culture systems under optimum temperature (25°-30°C)."

Luminous Bacteria

According to C. Pitogo, SEAFDEC Vol. X No. 1, p. 9 March 1988, "luminous bacteria have long been known to be associated with some crustacean mortalities in the wild, but such infections have not been reported in penaeids. Death of the hosts due to luminous bacteria was always preceded by visible luminescence (that can be observed at night) resulting from the large concentration of bacteria in the body fluids of the affected animals."

In *Penaeus monodon* hatcheries in many parts of Asia, larval mortalities due to luminous bacteria have become widespread and have caused the temporary shutdown of many rearing operations.

Luminescence observed in infected larvae consisted of a continuous emission of greenish light. Brightly luminescing weak larvae settled to the bottom and got entangled with the sediments, sometimes forming luminescent mats on the tank bottom. From the number of luminous larvae in the tank during the time of observation, it is possible to roughly predict the resulting mortality. Primary bacterial isolation of heavily-infected larvae revealed that purely luminous colonies can be recovered on the agar media. Two species of vibrios, *Vibrio harveyi* and *V. splendidus* were identified, with *V. harveyi* being the more dominant species.

The observed incidence of infection was highest at the postlarval stages and lowest at the naupliar stages, although this observation did not correlate with the occurrence of mortalities in the respective rearing facilities.

It was found that the bacteria infecting the larvae can also be readily isolated from natural seawater near the shore and the sediments.

It is very likely that the water acts as the main carrier of infectious agents. Infection in *Penaeus monodon* was detected as early as the egg stage. The use of contaminated spawning water may be the source of the bacteria. The possibility of transmission of the disease through transovarian means remains to be verified.

The number of luminous bacteria per ml was many times higher for the rearing water of infected stocks than the seawater source. This indicates that the rearing system provides a favorable environment for the multiplication of this bacteria. Many reports have shown that bacteria proliferate in fecal material and excess food accumulating in the rearing tanks.

According to Cecilia Baticados in SEAFDEC (Vol. X, No. 1, p. 9, March 1988), "The control of luminous bacterial infection in shrimp larvae, as in other microbial infections, consists primarily of environmental, biological, and chemical methods. It is always best to prevent the entry of the pathogen of disease agent into the hatchery. Applying treatment when the disease is already present is a difficult process and may not always succeed, especially when the

shrimp larvae are already too weak. The following are some guidelines which may help prevent and control the occurrence of luminous bacteria in shrimp hatcheries:

- Water for spawning must be kept clean. Remove scum after spawning as these may attach to eggs and could encourage bacterial growth. Eggs may be disinfected with 20 ppm (mg/l or g/ton) Tide detergent for 2 h and rinsed thoroughly before hatching (Li-Po and Sanvictores, 1986) to remove surface bacteria, fungi, and debris.
- Stock healthy, clean and uninfected nauplii only. Healthy nauplii are phototactic, i.e., they are attracted to light. Water containing the nauplii must also be changed before stocking the larvae in rearing tanks.
- The rearing water must always be kept clean and free from sediments and debris. This may be done by using physical methods (through sand filters, ultraviolet sterilization, cartridge filters, filter bags, etc.) or chemical means (disinfection with 10 ppm chlorine).
- Siphon out and wipe off sediments/debris/algal growth and wastes from bottom and sides of rearing tanks since these could serve as substrates for bacteria to grow on.
- Always disinfect infected batches of shrimp with 200 ppm chlorine for 1 h before discarding these. It is important that discarded water/dirt/larvae from the hatchery do not drain directly into the sea to avoid polluting the source of rearing water as well as the environment.
- Provide the larvae with adequate food, i.e., the right quantity of good quality food at the right time. The ability of the shrimp to resist disease depends, to a large part, on its nutritional state.
- Avoid the indiscriminate use of antibiotics/drugs in shrimp culture. Drug resistant strains of the luminous bacteria have been isolated in areas where commonly used antibiotics such as chloramphenicol, penicillins, erythromycin, kanamycin, oxytetracycline, polymyxin, streptomycin, and sulfa drugs have been regularly used as part of the rearing protocol. (So far, some degree of success has been met only with nitrofurans, e.g., furazolidone, but recent personal communication (1990) with Cecilia Baticados indicates that larval deformities may occur if these drugs are used). Infected larvae (protozoae, mysis) may be treated with 10 ppm pure furazolidone for 12 h for 4-5 consecutive days. Treatment is best conducted at nighttime when the temperature is cooler (28-29°C) with almost complete water change (80-100 percent) after 12 h. Infected nauplii may be exposed to the drug for only 6 h. It is important that such protocol be strictly followed only in cases of infection; otherwise, regular exposure to the drug at low levels could result again in the development of resistant strains of bacteria. Continued exposure to the drug at the recommended level but beyond the recommended period could result in morphological deformities in the larvae."

Several groups have reported effective therapy of these diseases using antibiotics such as Furance, Furacin, Terramycin, Aureomycin, and Chloramphenicol, and antibacterial chemotherapeutics such as formalin, malachite

green, and methylene blue (Aquacop, 1977; Tareen, 1982; Lightner, 1983). Vaccines against *Vibrio* sp. have been reported by Lewis and Lawrence, (1983) to be potentially effective in preventing losses due to *Vibrio* spp. infections in aquarium and pond-reared *P. setiferus*, but the efficacious use of this vaccine in penaeids remains to be documented.

Luminous bacteria are now causing problems in hatcheries (personal communication Fernando Carvaca-ESPOL, 1990), and in grow-out ponds in Ecuador and antibiotic treatment in feeds are being considered (personal communication with Jose Villalon, 1990).

"The occurrence of luminescence in *Penaeus monodon* larval cultures followed by significant mortality of the larvae has been observed for quite some time in the Aklan Province on Panay Island, Philippines. It was not until 1987, however, that the microorganisms responsible for this phenomenon were isolated and identified as predominantly *Vibrio harveyi* and occasionally as *V. splendidus*. This study was performed to determine: (1) the invitro sensitivity of the luminous bacterial isolates *V. harveyi* and *V. splendidus* to various drugs, (2) the minimum inhibitory concentrations (MICs) and the minimum bactericidal concentrations (MBCs) for drugs to which luminous vibrios are sensitive, and (3) the tolerance of *Penaeus monodon* larvae the bactericides."

The study's abstract states: "Only chloramphenicol, sodium nifurstyrenate and the nitrofurans (furazolidone, nitrofurazone, nitrofurantoin and Prefuran) showed relatively low MICs and MBCs (<25ug ml⁻¹). The bacteria showed various responses to chloramphenicol, and Prefuran and low sensitivity to oxytetracycline. Chloramphenicol, oxytetracycline and Prefuran are commonly used in shrimp hatcheries. Shrimp larvae showed high survival rates and active swimming movement after 25-hour exposure to in vivo bactericidal dose of chloramphenicol, Furacin, nitrofurantoin (protozoa only), oxytetracycline (nauplius only), Prefuran (mysis only) and sodium nifurstyrenate, but the drugs cause deformities in the carapace, rostrum and setae. Chemical control of luminous vibriosis among shrimp larvae appears limited, based on the efficacy of existing and readily available drugs, because of the possible development of resistant strains of bacteria and the limited tolerance of the shrimp larvae to the drugs."

Source: Diseases of Aquatic Organisms. Studies on the chemical control of luminous bacteria *V. harveyi* and *V. splendidus* isolated from diseased *P. monodon* larvae and rearing water. M.C.L. Baticados, C.R. Lavilla-Pitogo, E.R. Cruz-Lacierda, L.D. de la Peña and N.A. Suñaz (Fish Health Section, Aquaculture Department, Southeast Asian Fisheries Development Center, Tigbauan, Illilo 5021, The Philippines). V-9, N-2, P-133, October 4, 1990.

Fungi

Several species of fungi infect penaeids and some are major pathogens of these animals. Several reports have been published that expand the documented geographic and host range of *Lagenidium* sp., *Sirolopidium* sp., and *Fusarium solani*. Members of these genera were reported to cause disease losses in cultured *P. semisulcatus* in Kuwait

(Tareen, 1982), and in *P. chinensis* cultured in the Yellow Sea region of China. Large-scale hatchery losses of eggs and larvae to *Lagenidium* sp. and *Sirolopidium* sp. were reported (Meng and Yu, 1980, 1982), and *Fusarium* sp. was reported to infect juveniles in grow-out ponds in the same area of China (Meng and Yu, 1982, 1983). As was the case in most of the bacterial species reported from cultured-penaeid shrimp, the imperfect fungus *Fusarium* sp. (all isolates that have been identified are *F. solani*), the phycocytous fungi *Lagenidium* sp. and *Sirolopidium* sp. appear to be present in virtually all shrimp-culture facilities throughout the world. This is not surprising because each of the fungi has a wide host range or can exist as a free-living saprophyte (Johnson and Sparrow, 1961; Moss and Smith, 1984). While no effective chemotherapeutants have been found for treatment of *F. solani* infections in penaeids (Hatai *et al.*, 1974; Lightner, 1981, 1983; Tareen, 1982), a number of effective chemotherapeutants have been identified and tested against *Lagenidium* sp. (Bland *et al.*, 1976; Lio-Po *et al.*, 1982).

The histopathology (Bian and Egusal, 1981) and pathogenesis (Hose *et al.*, 1984) of *F. solani* infections in penaeids have been reported. Penaeids respond to invasion by *F. solani* hyphae with an intense hemocytic response that includes hemocyte encapsulation, melanization, and the deposition of collagen fibers within a granulomatous lesion that surrounds and isolates the invading hyphae (Bian and Egusa, 1981). Studies of these lesions by a TEM test have shown that despite the intensity of host response, a large percentage of hemocyte-encapsulated *F. solani* hyphae remains viable within the granulomatous lesions (Lightner, 1981; Hose *et al.*, 1984). Contributing to the pathogenesis of *F. solani*, in addition to its direct invasiveness and destructive effect on host tissues, are secondary bacterial infections and changes in the hemolymph content of the host. Hemolymph from severely *F. solani*-infected *P. californiensis* was hypoproteinemic, hemocytotic, and frequently failed to coagulate (Hose *et al.*, 1984).

The Chinese have recently made important contributions to shrimp mariculture production on the world market (producing 165,000 MT of farm-raised shrimp in 1989) and have also made advances in hatchery-disease diagnosis and cures (Chen, 1988; Chen *et al.*, in press; Wu and Lu, in press, and Zheng, 1988).

Protozoan Parasitic Diseases

Microsporidians — Microsporidians (Protozoa, Microspora) cause a group of diseases in penaeids that are collectively called "cotton" or "milk shrimp disease." At least three genera of microsporidia, *Ameson* (= *Nosema*),

Agmasoma (= *Thelohania*), and *Pleistophora*, are known to infect captive-wild and cultured penaeids, especially in ponds or in enclosed natural bodies of water (Overstreet, 1982; Lightner, 1983). Tissues infected by these parasites include striated muscle, smooth muscle and the gonads. Infection prevalences in penaeid culture ponds have approached 10 percent (Couch, 1978). Severe infections in cultured penaeids may cause chronic-disease mortality (Couch, 1978; Lightner, 1983) and parasitic castration (Enriquez *et al.*, 1980), resulting in an unmarketable product.

Gregarines — Gregarines (Protozoa, Apicomplexa) are common inhabitants in the guts of wild and pond-reared penaeids (Johnson, 1978, 1989; Overstreet, 1978; Couch, 1983). Two genera, *Nematopsis* and *Cephalolobus*, are known in penaeids (Lightner, 1983). These organisms use a mollusk for completion of their life cycle and may be excluded from tank and raceway-culture systems (Johnson, 1978). Even when present in such large numbers as to occlude the midgut or hindgut lumen, gregarines do not appear to cause significant disease in penaeids.

Noninfectious Diseases

Diseases Caused by Epicommensals — Among the more serious diseases of cultured penaeids are those caused by noninfectious-epicommensal organisms. These organisms are common and apparently ubiquitous in shrimp-culture facilities. All life stages may be affected, but the most serious losses are encountered in juvenile and adult stages when the gills of the host become fouled (resulting in various forms of gill disease) by heavy infestations of epicommensal organisms such as filamentous bacteria, peritrich protozoans, and pinnate diatoms. The following is a list of the more commonly observed and reported epicommensal organisms that alone, or with other epicommensals, cause "gill disease" and surface fouling in cultured penaeids.

The most significant of these diseases listed in the chart below are discussed here.

Bacterial epicommensals

Leucothrix mucor is a very common ubiquitous estuarine marine bacterium, reported from every penaeid culturing area of the world (McKee and Lightner, 1982; Lightner, 1983). Consistent with this are reports of losses due to *L. mucor* in penaeids cultured in Kuwait and China (Meng and Yu 1980, 1982, 1983; Tareen 1982). *L. mucor* attaches to living and nonliving substrates and in penaeid-culture systems it readily attaches to the body surfaces of shrimp. In juvenile and older penaeids, *L. mucor* favors attachment to the gills and accessory-gill structures. Lar-

Bacteria

Leucothrix mucor
Thiothrix sp.
Vibrio spp.
Pseudomonas spp.
Flavobacteria sp.
Aeromonas formicans

Ciliates (Protozoa)

Zoothamnium spp.
Vorticella sp.
Lagenophrys sp.
Apostome ciliate
Suctora (Protozoa)
Acineta spp.

Blue-Green Algae

Spirulina subsalsa
Schizothrix calcicola
 (discussed later under
 toxic diseases)

Diatoms

Amphora sp.
Nitzschia sp.
Achanthes sp.

val and postlarval penaeids may become so fouled by *L. mucor* filaments that respiration, feeding, locomotion, and molting may be seriously impaired, resulting in mortalities. *L. mucor* is noninvasive and it causes no demonstrable pathology to the surfaces to which it attaches (Lightner *et al.*, 1975; Lightner, 1978). Severity of disease due to *L. mucor* in shrimp is related to organic loading of the culture system, to its oxygen content, and to the added stress of molting. Mortalities due to *L. mucor* surface and gill infestations are due to hypoxia.

Several other species of bacteria have been implicated in bacterial-gill disease and surface-fouling disease of cultured penaeids. Included among the filamentous forms are *Thiothrix* sp., *Cytophaga* sp. and *Flexibacteria* sp. (Lightner, 1983). Unlike *L. mucor*, inflammation and melanization of the gills often accompanies high levels of infestation by some of these filamentous bacteria (Lightner, 1978). Lewis *et al.*, (1982) reported aggregation of hatchery-reared *P. stylirostris* larvae by surface fouling due to infestations of *Pseudomonas piscicida*, *Aeromonas formicans*, and *Flavobacteria* sp.

Protozoan epicommentals

A number of species of protozoa have been reported to cause surface fouling and/or gill disease in all life stages of cultured penaeids (Overstreet, 1982; Couch, 1983; Lightner, 1983). The most commonly reported protozoans include the peritrich ciliates *Epistylis* spp., *Zoothamnium* spp., and *Vorticella* spp.; the loricate ciliate *Lagenophryss* sp.; an undescribed apostome ciliate; and the suctorian *Acineta* spp. (Couch, 1978, 1983; Overstreet, 1978, 1982; Meng and Yu, 1980, 1983; Lightner, 1983). Johnson (1978 p. 14) and (1989) shows an easy way to differentiate between *Zoothamnium* and *Epistylis*. *Zoothamnium* has a myoneme or muscle fiber visible in the stalk whereas *Epistylis* does not. As is the case with bacterial epicommentals, when abundant on the body surfaces, appendages, or gills, these protozoans can cause difficulties to the host in locomotion, feeding, molting and respiration. Like *L. mucor*, most of the protozoans cause no appreciable internal damage to the host surfaces or gills. The exception to this is the unidentified apostome ciliate which caused melanized hemocytic lesions in the gills of *P. aztecus* (Lightner, 1975; Overstreet, 1978, 1982).

Algae

A number of species of blue-green algae and diatoms have been reported to be among the epicommental organisms causing surface fouling and gill disease in cultured and captive penaeids (Lightner, 1983). *Amphora* sp. has even been observed growing internally in the gills of *P. setiferus* reared in a shallow, nonturbid, well-lighted tank (Overstreet and Safford, 1980).

Nutritional, Toxic and Environmental Diseases Detail

(Lightner, 1984; updated to 1990)

Nutritional Diseases

Although a number of the nutritional requirements of cultured penaeids have been identified and such nutrients

as the essential amino acids, cholesterol, linoleic acid, B-carotene and potassium are needed in penaeid diets for optimum growth, survival and appearance (New, 1976; Kanazawa, 1980), only one nutritional-disease syndrome of cultured penaeids has been described in detail. This disease, called black death or shrimp scurvy (Lightner *et al.*, 1977 and 1979) occurs in penaeids that are reared in culture systems lacking algae and receiving diets with insufficient ascorbic acid. The disease has not been observed in shrimp cultured in systems where there is at least some algae. Shrimp with black-death disease possess melanized hemocytic lesions in the epithelial and supportive connective tissues of the general-body cuticle, the foregut and hindgut, the eyestalks, and the gills. The lesions are most prominent in tissues with a high-collagen content (Hunter *et al.*, 1979). Addition of L-ascorbic acid to the shrimp's ration or rearing shrimp in the presence of algae effectively prevents black death disease (Lightner *et al.*, 1979).

Toxic Diseases

Hemocytic enteritis (HE) — Blooms of certain filamentous blue-green algae, all belonging to the family Oscillatoriaceae, have been implicated as causing the HE disease syndrome in primarily young juvenile penaeids. The occurrence of HE seems to be ubiquitous, and examples of the disease exist from marine and freshwater shrimp aquaculture facilities in North America, Hawaii, Brazil, The Philippines, and Israel. One species of blue-green algae, shown experimentally to cause this syndrome, is *Schizothrix calcicola* (McKee, 1981). *S. calcicola* occurs in both freshwater and seawater, and has been reported to possess a potent endotoxin (Keleti *et al.*, 1979). While HE is most commonly observed in early juvenile penaeids, it has been observed in subadult penaeids as well.

The principal lesion of HE, which occurs as the result of algal endotoxin released in the gut from ingested algae, is a necrosis and marked hemocytic inflammation of the mucosal epithelium of the midgut and its caeca (Lightner, 1978), accompanied by necrosis and degeneration of the hepatopancreas (Lightner and Redman, 1984). The cause of death in shrimp with HE may be due to osmotic imbalances, poor absorption of nutrients, or to secondary-bacterial infections. Species of *Vibrio*, usually *V. alginolyticus*, are the organisms most commonly isolated from the septic hemolymph of shrimp with HE (Lightner 1983). Mortality rates in raceway-reared *P. stylirostris* with HE have reached 85 percent (Lightner, 1978), but usually are less than 20 percent. Runting of shrimp affected with HE is apparently due to midgut disfunction and to the length of time required for the midgut mucosa to regenerate and is a chronic effect in animals that survive the disease.

Dinoflagellate Poisoning — Dinoflagellate blooms (red tides) have been circumstantially linked to serious mortalities of cultured-penaeid shrimp in Mexico (Lightner *et al.*, 1980), but a cause-and-effect relationship of mortality to the suspect species of dinoflagellates has not been experimentally demonstrated (Lightner, 1983). The occurrence of a toxicity syndrome called "blue shrimp syndrome unknown" (BSX) in *P. californiensis* and *P.*

stylirostris cultured in Mexico (Lightner 1983) has been correlated to the occurrence of red tides. Shrimp with BSX die during molting or following handling stress, and in an affected population a large percentage of the shrimp has been observed to develop "blunt heads." This condition was thought to develop from damage to the head appendages from the convulsive behavior pattern that occurs in this syndrome (Lightner, 1983). Dinoflagellate toxins are thought to be nontoxic to crustaceans (Sievers 1969), but only short-term toxicity tests have been run on shrimp. However, during those tests the few shrimp that molted also died. That observation and the circumstantial association of red tides and the BSX syndrome in Mexico indicates that the importance of red-tide toxins to penaeids may be significant. During the red-tide outbreak in Texas in 1986, it appeared that the red-tide *Ptychodiscus brevis* did kill penaeid shrimp larvae. Information gathered for a larval-rearing run for a course in Port Aransas, Texas (Treece, 1986) indicated that it was necessary to charcoal filter all water to keep the red tide from killing larvae. Medlyn (1980) also discussed the susceptibility of *Artemia* to *Ptychodiscus brevis* toxin(s).

Aflatoxicosis and Red Disease — Aflatoxicosis and red disease are discussed together here because of the close similarity of their histopathology (Lightner *et al.*, 1982; Lightner and Redman, 1985). However, the etiology of red disease is unknown, and while it may have a toxic cause, the possible role of an infectious agent in its etiology has not been completely explored. Both of these diseases have, as their principal feature, a necrosis of the hepatopancreas that is accompanied by marked intertubular hemocytic inflammation, tubule encapsulation and melanization. Toxic constituents of other plant-food stuffs are discussed by Liener (1980).

Aflatoxicosis — Necrosis and inflammation of the hepatopancreas, mandibular organ, and hematopoietic organs are the principal features of artificially-induced aflatoxicosis (Lightner *et al.*, 1982). Although aflatoxicosis has not been proven to be an important disease in cultured penaeids, the mechanism for it becoming an important disease is in place. Penaeids reared in semi-intensive or intensive systems are fed artificial diets that may contain ingredients which, on occasion, can contain aflatoxin in sufficient amounts to result in aflatoxicosis (Arafa *et al.*, 1979; Wiseman *et al.*, 1982). Aflatoxin can also be produced "in situ" in penaeid feeds improperly stored under warm and humid conditions typical of penaeid-culture regions (Wiseman *et al.*, 1982). This could include microencapsulated diets for hatchery use and/or postlarval feeds.

The principal lesions of aflatoxicosis in penaeids (Lightner *et al.*, 1982) occur in the hepatopancreas and the mandibular organ. In the hepatopancreas acute and subacute aflatoxicosis is expressed as necrosis of the hepatopancreatic tubule epithelium that proceeds from the proximal portion of the tubules to the peripheral-tubule tips. A marked intertubular-hemocytic inflammation, followed by encapsulation and fibrosis of affected tubules, follows in subacute and chronic aflatoxicosis that displays a necrosis of the peripheral epithelial cells of cords within the gland that progresses proximally to the central vein. Only a slight hemocytic inflammation ac-

companies the degenerative changes in the mandibular organ (Lightner *et al.*, 1982). Further information on aflatoxicosis disease diagnosis and control measures are discussed by Lightner (1988).

Red Disease — Red disease, or red discoloration, was first noted in Taiwan (Liao *et al.*, 1977; Liao, 1977) in cultured *P. monodon*. The disease has also been observed in captive wild-adult *P. monodon* and in juvenile and adult-cultured *P. monodon* in the Philippines (by, J.F. LeBitoux and C. Emerson, Filipinas Aquaculture Corp., 1982) and in pond-reared *P. stylirostris* in Hawaii (Lightner and Redman, 1985). Liao (1977) noted that in some years red disease in Taiwan was "quite serious," especially in cultured-adult *P. monodon*. The hepatopancreas of normal decapod crustaceans contains a variety of carotenoid pigments, with most of the total-body content of beta-carotene being stored in the hepatopancreas (Goodwin, 1960). Atrophy and necrosis of the hepatopancreas result in release of stored beta-carotene and other carotenoids into the hemolymph. Distribution and deposition of hepatopancreatic carotenoids by the hemolymph into the tissues explains the red-tissue discoloration that characterizes this disease.

Liao's *et al.*, (1977) observations of *P. monodon* with red disease indicated the development of red disease to be subacute or chronic, with no evidence of an infectious etiology. An infectious etiology was considered unlikely because the disease was refractory to antibiotic therapy, the disease was observed only in *P. monodon* (even when polycultured with *P. penicillatus* and *P. semisulcatus*., and because attempts to transmit the disease to unaffected *P. monodon* failed.)

Liao *et al.*, suggested a link between feeding rancid fish to the shrimp and red disease because the disease was not observed when only fresh fish was fed. However, Emerson noted that red disease in the Philippines occurred in pond-reared and captive wild *P. monodon* fed exclusively artificial diets. However, Emerson (1982) indicated that in his experience red disease was most common in manure-fertilized ponds with thick anaerobic detritus deposits.

Liao *et al.*, (1977) described the sequential development of red disease in *P. monodon*: affected shrimp passed through four stages with the earliest detectable signs of the disease being a yellowish-green discoloration of the shrimp's body. Otherwise, affected shrimp remained active and displayed normal behavior. During the next two to four days, affected shrimp became reddish with the normally white gills and the pleopods also becoming reddish. Finally, after five to seven days affected shrimp became distinctly red and totally lost their normal brown and tan pigment (banded) pattern. Shrimp in the final stages of the disease were lethargic, anorexic and showed a tendency to excessive surface fouling by epicommensal organisms. The amount of body fluid in the cephalothorax increased over that of normal shrimp and had a foul odor. The hepatopancreas was reported to be yellow or pale.

Histological examination of *P. monodon* and *P. stylirostris* with red disease revealed a marked atrophy of the hepatopancreas and the presence of numerous melanized inflammatory lesions in the hepatopancreas, antennal gland, mandibular organ, gonads, midgut and gills (Lightner

and Redman, 1985). Hepatopancreatic inflammatory lesions were the most consistently observed lesion type. The affected hepatopancreata were atrophied (reduced by as much as 50 percent of expected normal size), usually contained multiple hemocyte-encapsulated hepatopancreas tubules with necrotic or sloughed epithelial linings, and possessed a marked hemocytic infiltration in the intertubular spaces. Brown and Brenn gram-staining of affected hepatopancreata of *P. monodon* and *P. stylirostris* showed the tubule lesions to contain masses of gram-negative rod-shaped bacteria and in *P. monodon* occasional prominent clusters of large (1.0 to 1.5 μm diameter) gram-positive cocci or short rods. Unlike the gram-negative rods that were always present in the tissue debris in the lumen of hemocyte-encapsulated tubules, the gram-positive organisms in *P. monodon* were observed in clusters within cytoplasmic vacuoles of tubule epithelial cells as well as in the lumen debris.

The significance of the relatively large numbers of gram-positive bacteria present in many of the *P. monodon* hepatopancreata with red disease is not known. Gram-positive bacteria do not typically make up a significant part of the normal microflora of penaeid shrimp (Vanderzant *et al.*, 1970; Vanderzant *et al.*, 1972; Lewis, 1973; and Yasuda and Kitao, 1980) or the known pathogens of penaeids (Lightner, 1983). The absence of these gram-positive bacteria in the Hawaii-reared *P. stylirostris* with red disease suggests either that they are not the etiological agent of red disease or that red disease may be a generalized syndrome with more than one cause, resulting from a necrosis of the hepatopancreas and release of its content of carotenoid pigments into the hemolymph (Lightner and Redman, 1985). This disease has not been as much of a problem in hatcheries as it has usually been found in the grow-out phase.

Gut and Nerve Syndrome — This idiopathic, proliferative condition affecting the midgut and ventral-nerve cord has only been observed in populations of postlarvae and juvenile *Penaeus japonicus* reared in ponds, tanks, and raceways in Hawaii (Lightner *et al.*, 1984). It has apparently not been observed in *P. japonicus* reared in Japan or elsewhere. The disease was named gut and nerve syndrome (GNS) to reflect its idiopathic nature and the principal organs affected. The severity and high prevalence of GNS in virtually all populations of cultured *P. japonicus* studied since 1980 in Hawaii had precluded the successful rearing of this species in Hawaii, particularly in high density culture (Lightner *et al.*, 1984). Although there is no evidence to support the hypothesis, GNS is thought to be caused by a toxin, possibly an algae toxin, that is unique to Hawaii (Lightner *et al.*, 1984). The principal lesions observed in *P. japonicus* with GNS are a hypertrophy of the anterior midgut mucosal epithelium-basement membrane (BM) and a hyperplasia of the epineurium that covers the ventral-nerve cord and segmental ganglia in the gnathothorax.

Black-Gill Disease — A number of disease syndromes of cultured penaeids are accompanied by the presence of black (melanized), inflamed lesions in the gills (Lightner, 1977; Lightner and Redman, 1977). In fact, black gills may accompany many of the syndromes described earlier in

this review and are also frequently a sign of toxic syndromes caused by chemical irritants including certain heavy metals, oil, ammonia, nitrite, and ozone.

Gas-Bubble Disease — Gas-bubble disease has been reported to occur in penaeid shrimp as a result of supersaturation of atmospheric gases and oxygen (Lightner, 1983). Shrimp are similar to fish in their sensitivity to supersaturation of atmospheric gases. Although the level of nitrogen or atmospheric-gas supersaturation required to cause gas-bubble disease in penaeids has not been formally studied, a threshold of about 118 percent saturation is assumed (Lightner, 1983). Oxygen caused gas-bubble disease in penaeids was reported to occur when oxygen reached or exceeded 250 percent of normal saturation in seawater (Supplee and Lightner, 1976). Regardless of the gas causing gas-bubble disease in shrimp, the clinical signs are the same. The most obvious sign of gas-bubble disease is that affected shrimp float (in all other diseases, dead or dying shrimp sink). Examination of fresh preparations of gills or whole tissue by microscopy reveals the presence of gas bubbles.

Cramped Tail Condition — This occasionally-observed condition of penaeid shrimp has been reported to occur in the summer months when both air and water temperatures are high (Lightner, 1977; Liao *et al.*, 1977; Johnson, 1975; Meng and Yu, 1980). Penaeids with cramped tails (while still alive) have a dorsal flexure of the abdomen that cannot be straightened. This condition typically follows handling, although shrimp have been observed with cramped tails in undisturbed ponds (Johnson, 1975). The cause of cramped-tail condition is unknown, but its occurrence only during the summer suggests that elevated water and air temperatures, the handling of shrimp in air that is warmer than the culture-system's water, and other stresses may contribute to the cause of the condition. This is usually not noticed until the grow-out phase.

Muscle Necrosis (Spontaneous Necrosis) — Muscle necrosis is the name given to a condition in all penaeid species that is characterized by whitish, opaque areas in the striated musculature, especially in the distal-abdominal segments (Rigdon and Baxter, 1970). The condition follows periods of severe stress (from low oxygen, sudden temperature or salinity changes, severe gill fouling, etc.) (Lakshmi *et al.*, 1978; Lightner, 1983). It is reversible in its initial stages, but it may be lethal if large areas are affected. "Tail rot" is the name given to the chronic and usually septic form of the disease when the distal portion of the abdomen (or appendages) becomes necrotic, turns red, and begins to slough.

Methods for Routine Examination of Larval Shrimp (Johnson 1989)

Larval stages and young postlarvae are small enough to examine whole as wet mounts with a compound or stereoscopic microscope. Upon examination look externally for damaged or deformed structures. Opaqueness or other discoloration of the musculature should be recorded as to location and distribution. Color and spatial distribution of chromatophores are characteristic to stage or species and abnormalities should be noted. Presence of sessile protozoa and bacteria may be noted by microscopical

scanning of the body surface. The blood (hemolymph) can be easily observed through the transparent exoskeleton, particularly at the extremities. Observe for fungi, viruses, protozoa and motile bacteria using a compound microscope. In the large larval stages, the digestive tract and its contents may be easily observed through the exoskeleton. Heart, digestive gland and other organs can be examined in similar manner. Mashing a whole animal between cover slip and slide will allow more detailed examination of individual tissues.

Vital stains may be used to highlight tissue damage. Larvae are placed in stain solution for 10 to 30 minutes. Aqueous solutions (0.1 percent) of methyl green, neutral red, Janus green or trypan blue will mark lesions. Sodium chloride crystals added to staining compartment will convert staining solution for marine species.

Particular Examinations

Bacteriological — Take larval shrimp and place in depression slide. Using a compound microscope (preferably phase microscopy) focus at 400X on an extremity of the body. Motile bacteria within the blood should be easily discerned.

Add 100 ml of distilled water or chlorinated tap water to each of three or four clean beakers. Arrange beakers in a row. With a pipette or dropper add three shrimp larvae to the first beaker. Swirl water with shrimp. Rinse dropper. Remove shrimp to next beaker repeating procedure so as to wash shrimp clean of external microbes. Arrange another four or five beakers in a row. To the first beaker add 0.002% (w/v) iodine (as iodophore i.e. Wescodyne, Ciba-Geigy) or 1 mg/l quaternary ammonia compound (i.e. benzalkonium chloride) for 10 minutes. Rinse by passing through other beakers. Remove shrimp from last beaker with a loop and place on agar surface of prepared plate. Disrupt structure of shrimp with the loop and spread about on part of the plate. Do the same for the other shrimp. The intent of this procedure is to isolate internal bacteria onto bacteriological media. It does not differentiate between bacteria of tissue fluids and those of the digestive tract except in the case of nauplii.

Fungal — Fungi are easily seen by light microscopy but isolation may be desired for identification or other purposes. Place infected larvae in sterile chamber with 1 ml of sterile water (seawater if marine shrimp) that contains 10 mg/l of chloromycetin. Two hours later loop transfer zoospores (check for presence with microscope) by streaking onto savouraud dextrose algae plates. (Adapted from: M.S. Gorttel and M.K. Toohey, 1983, *J. Invert. Pathol.* 41:1-7).

Virological — Viral examination of larvae is similar to that described for larger shrimps. Routine examination of tissues for occlusion viruses, however, applies squash of whole animal's mass. In larger larvae (postlarvae) it is advantageous to remove a portion of the tail before making the wet-mount squash. This can be done by severing the tail at mid-point of the first tail segment with a scalpel while viewing through a dissecting microscope. This procedure will cause the digestive gland and anterior intestine to wash free of other body portions. Certain stains (e.g. 0.1% aqueous malachite green) in tissue squashes.

Methods for Routine Examination of Juvenile and Adult Size Shrimp

- When a shrimp is dissected, the species, length and living condition (active, sluggish, type of unusual behavior) should be described.
- **Estimation of the freshness in dead shrimp is made when a non-living sample is examined. Criteria for this estimation are:** smell, appearance of darkened fringes of carapace, gills and internal organs, (Especially integrity of digestive gland) and presence and grade of postmortal stiffness (rigor mortis). Only recently dead shrimp are suitable for examination. If the gills or cuticle have browned, smell is intensive, musculature has lost translucency or become pink and internal organs have begun to decompose, the shrimp is not suitable. The presence of postmortal stiffness indicates that the carcass is still fresh enough for dissection.
- **Examine visually :**
 - *Exoskeleton or cuticle* (for erosive areas, scars, whitish or blackish areas, ulcers, deep wounds, changes in pigmentation, knots or nodes, parasites, fungus or defects)
 - *Mouth*
 - *Carapace* (external or internal, as exoskeleton)
 - *Antennae* (incomplete, broken)
 - *Eyes* (wounds, blindness)
 - *Anus* (color and appearance of the feces pressed out by slight pressure on the sides of the body)
 - *Gonads* (for proper development in adults, swelling and darkening of vas deferens)
 - *Hold shrimp* to light and try to detect parasites embedded in body. This examination should not last too long because cuticle and gills must still be wet for the following steps.
- **Blood:** If the shrimp is still alive, insert a capillary tube through the membrane that separates the carapace and the abdomen. This may be easily done if the tube is held in one hand, the shrimp in the other with the cephalothorax bent forward. Take care not to insert tube into the intestines. Alternate: Cut off one-third of antenna and utilize the drop that forms on the newly cut tip. Examine for ability of blood to clot, protozoa in fluid using stereoscopic microscope and bacteria using compound scope. Take some fluid from shrimp and quickly spread on a slide for staining purposes.
- **Examination of cuticular surface for parasites of microscopic size and bacteris:** Prepare two slides with a drop of water on them. Cut portions off using scissors and place the samples in the water drops. The samples should be taken from parts where parasites or bacteria appear more abundant, i.e., from visibly changed areas, particularly edges of segments or tips of appendages. Cover the preparation with a coverslip and examine for motile organisms. If bigger parasites are expected, examine first under stereoscopic microscope. With examination of small shrimp it is most convenient to cut off whole appendages, especially uropods.
- When lesions are present, stained smears should be prepared from the changed area: The margin of the

lesion and the tissue where the changes occur should be used for smearing. Material should be taken with a sterile loop or scalpel and evenly (not too thick) smeared on at least two clean slides.

- **Examination of gills:** Gills are first examined in position (by removing the gill cover) for color, amount of detritus, presence of parasites, cysts, necrosis or other changes. All gills on both sides should be examined. Then one or two gill filaments are taken out by means of scissors and forceps. They are put on a glass slide and observed under a stereoscopic or compound microscope. With bigger shrimp, several portions of gill filaments should be cut off with scissors (choosing those which look abnormal) put a drop of water on the slide, cover with coverslip and examine under a compound microscope for presence of parasites, cysts, fungus, bacteria and changes in the structure. Look at normal and abnormal gills to compare their morphology.
- **Cephalothorax:** The adult or juvenile shrimp should be opened with scissors by making four cuts. The first removes the rostrum at its base. The second cut starts at the rostral base and proceeds posteriorly along the side at the level that the gill cavity begins and stops at the end of the carapace. The third cut is the same as the second, but on the other side. The fourth cut proceeds posteriorly along the dorsum to the end of carapace. Care must be taken in all cuts to avoid damaging underlying organs. After cuts are made the detached exoskeleton parts are teased away from underlying tissue. This exposes organs. Observe the organ position, hemolymph, and any free parasites. Fluid color and turbidity should be recorded. Note cysts on surface of digestive gland or in surrounding tissues. Mesenteries are normally transparent, smooth, glistening and moist. Any changes should be recorded. Check them for parasites, turbidity, thickening, etc. Similarly examine heart. Remove heart with forceps and examine further with microscope noting parasites or abnormal tissue.
- **Digestive system:** Examine digestive gland for internal and external color, size, texture and presence of parasites. Take a small piece of the tissue, put it on a slide, press it with a coverslip and examine under a microscope. Look for motile bacteria, viral occlusion, or parasites. Also note presence and amount of any necrotic tissue in the gland.

Prepare shrimp for removal of digestive system: cut off tail at the anterior of the sixth abdominal segment and save. Make cuts (on already partially dissected shrimp) along either side of the dorsal midline and remove exoskeleton and tissues to expose intestine. Then find and cut esophagus at the bottom of the cephalothorax. Remove digestive system taking care to release it from the thoracic partitions. Remove digestive gland. Examine esophagus, stomach, stomach filter, anterior intestine, mid-intestine and posterior intestine separately by placing portions on slide in a drop of water and teasing apart with dissecting needles. Observe for protozoan and metazoan parasites and damaged tissue. Take the tail portion cut off earlier and dissect out the rectum and examine as for

other parts.

- **Musculature:** Examine musculature for unusual opaqueness; remove unusual tissue and place a small portion on a slide in a drop of water. Mash with coverslip and examine for fungi, bacteria, microsporidian and metazoan parasites. Remove a segment of a leg and tease out the internal parts for observation on a slide.

Particular Examinations

Bacterial isolation — Visibly examine the shrimp for lesions, record if present. Wash shrimp in tap water so as to rinse the specimen of excess surface bacteria. Flame an inoculating loop and set it aside. Wet a cotton ball with alcohol and swab the surface and the area around the membrane that dorsally separates the carapace and the abdomen. Take the inoculating loop and press it through the membrane into the haemocoel. Do not cut intestine with loop. Streak the material on the loop to surface of the plated bacterial medium. Mark plate with the date and your name. Place in incubator for growth.

An alternate method of obtaining blood is to sterilize the surface of an antenna using an alcohol soaked cotton ball. The distal third is then cut off with a sterile blade. The drop that forms, upon bleeding may be touched directly to the plate and then streaked with a loop. Blood may be obtained from larger animals with a sterile syringe which is inserted into hemolymph space after swabbing dorso-lateral surface of carapace. Blood may also be used in making a hanging drop slide for direct bacterial examination.

After careful surface disinfection and dorsal carapace removal, a portion of digestive gland tissue may also be removed with watchmaker's forceps and streaked directly onto plated media. Although the gland's tubules feed directly into the digestive tube, bacteria of particular type and magnitude will be isolated from this gland in moribund shrimp.

Identification of isolated bacteria — Various manuals are available that describe methods for bacterial identification. The key that follows is helpful in identifying isolates to level of genus. Also provided is a list of media and test procedures of special importance in presumptive identification of bacterial isolates. It is based on facility expectations of a field lab.

Media and test procedures of special importance in presumptive identification of bacteria.

1. **Brain heart infusion agar**
 dehydrated BHI agar 26.0 gm
 distilled water 500.0 ml
 Heat to boiling to dissolve the medium completely. Sterilize.
 Plates: Pour sterilized media into sterile petri dishes one third full. Let stand for ten minutes with lids off center so as to make an outlet for steam. Cover, let stand until it hardens. Invert, identify media and refrigerate.
 Tubes: Fill tubes to desired amount; place caps on loosely and sterilize. Tighten caps after autoclaving. Lay tubes at an angle to solidify leaving a butt at the end of tube.

- Method of sterilization: Autoclave for 15 minutes at 15 pounds of pressure 121°C.
2. **Brain heart infusion agar with salt.**
Add NaCl to the above medium to make 3 percent salt medium. Prepare as indicated for BHI.
Salt should be added to media for isolation procedures that involve animals from distinctly marine water.
 3. **Tryptic soy agar**
dehydrated T S agar 20.0 gm
distilled water 500.0 ml
Heat to boiling to dissolve the medium completely. Sterilize. Prepare as for BHI. For marine shrimp work make up 3 percent salt medium.
 4. **Azide dextrose broth and dextrose agar with sodium azide**
(for gram positive bacteria).
Azidedextrose broth:
beef extract..... 4.5 gm
tryptone.....15.0 gm
dextrose 7.5 gm
sodium chloride.....7.5 gm
sodium azide.....0.2 gm
distilled water.....1.0 liter
Azide dextrose broth is available from Difco Laboratories. Streptococcus can be separated from Staphylococcus and Micrococcus with catalase test. For dextrose agar add 0.2 gm sodium azide/liter medium.
 5. **Nutrient broth**
beef extract.....3.0 gm
peptone.....5.0 gm
distilled water.....1.0 liter
Prepare as above in tubes but do not slant since this is liquid media. Make with and without NaCl.
 6. **O F basal medium (Hugh Leifson)**
Preparation:
dehydrated O F basal medium.....4.7 gm
distilled water.....500.0 ml
Heat to boiling to dissolve the medium completely. Dispense 4.5 ml into each tube.
dextrose.....10.0 gm
distilled water.....100.0 ml
Add 0.5 ml of dextrose solution to each tube.
Parafin oil.
Overlay half of tubes with oil for a depth of 1 one half inch.
Procedure:
Inoculate two tubes, one with oil and one without. Place loop well below surface in medium and swish. Read at 24 and 48 hours.
Results: tests oxidation and fermentation of carbohydrate. Positive, acid (A) is yellow color: negative, alkaline (Alk) remains green.
 7. **NH₃**
Preparation:
Add the following together:
0.1% peptone
0.5% NaCl
0.3% agar
0.3% K₂HPO₄
0.001% phenol red
 - 1.0% arginine HCl
water to 100%
Trisate with .1 n NaOH until pH is 6.8. The color should be orange. Autoclave. The final pH should be 7.2.
Dispense into tubes and cover with one half inch of oil. Procedure: inoculate as for the O F basal medium. Incubate and read at 24 hours.
Results: positive, intense pink color develops; negative, no change.
 8. **Cytochrome oxidase test**
Procedure: Smear a large amount of bacteria on Pathotec-CO test paper (General Diagnostic Division, Warner-Lambert Co., Morris Plains, N.J. 07950).
Results: positive, bright blue color develops within 30 seconds; negative, no change in color.
 9. **Catalase**
Procedure: Drop five drops of 3% hydrogen peroxide on a white spot plate. Scoop a moderate amount of bacteria from a colony and place in the peroxide.
Results: positive, strong bubbling in three to five seconds; negative, no bubbling.
 10. **Flagella stain (Bacto Flagella Stain, Difco Laboratories, Detroit, Michigan, U.S.A.)**
Stain preparation
dehydrated Bacto Flagella Stain ... 1.9 gm
95% ethanol 33.0 ml
distilled water 67.0 ml
Mix water and ethanol then add stain. Shake for 10 minutes.
Procedure:
a. Grow the bacteria in 5 ml of half-strength nutrient broth for about 18 hours.
b. Add 1 ml of 5-10 percent formalin and centrifuge (3000 rpm, 10 minutes).
c. Remove the supernatant fluid by aspiration.
d. Add 10 ml distilled water and resuspend sediment.
e. Centrifuge at 3,000 rpm for ten minutes
f. Repeat wash.
g. Resuspend bacteria in 10 ml distilled water.
h. Using precleaned slides (Corning) pour a drop of suspension onto slide.
i. Tilt slide and allow to run down to end of slide.
j. Air dry the film (do not heat).
k. Place slide on staining rack and add 1 ml of the stain solution. Stain for ten minutes.
l. Flood off the stain with water.
m. Drain and allow to air dry.
n. Examine slide with microscope searching for bacteria with flagella. Many slides may have to be examined before flagella are found.
 11. **Susceptibility testing**
a. From an isolated bacteria colony remove a loop of bacteria and place on BHI plate.
b. Using a sterile swab (cotton on wooden stick) or inoculating loop, distribute bacteria to all parts of the media surface.
c. If media surface is not particularly moist, the addition of several ml of sterile water will facilitate distribution of bacteria.

- d. Add sensitivity discs to the plate, spacing so that overlaps of diffusion will not cause confusion when reading.
- e. Susceptible bacteria will not grow on area where antibacterial affects them and a ring of no growth is formed.
- f. Read whether the microorganism is very sensitive, moderately sensitive, slightly sensitive, or resistant.
- g. If the sensibility discs are not marked it will be necessary to mark name on plate surface just under disc.

12. Inhibition by vibriostat

Make a 5 percent solution of 2,4-D amino -6, 7-disopropyl pteridine phosphaaate (known as 0/129) in distilled water of chloroform. Dip blank antibiotic sensitivity discs in solution and allow preparation to dry. Use as for prepared antibiotic discs by the method described above under susceptibility testing. Inhibition of growth by this compound is characteristic of most vibrios compound. 0/129 is available from: Gallard Schlesinger Chemical Mfg. Corp., 854 Mineola Ave, Carle Place, LI., NY 11514 and BDR Chemicals Ltd., Poole, England.

13. Gram stain

Solutions:

A. Modified Hucker's Crystal Violet

Solution A

ethyl alcohol 95% 20.0 ml

crystal violet (certified) 2.0g

Solution B

Ammonium oxalate 0.8 g

distilled water 80.0 ml

Mix solutions A and B

B. Iodine 1.0 g

potassium iodide 2.0 g

distilled water 300.0 ml

C. Decolorizer

ethyl alcohol 95.0 ml

acetone 5.0 ml

D. Counterstain

safranin 0.85% 6.0 g

ethyl alcohol 20.0 ml

distilled water 200.0 ml

Staining procedure:

- a. Air dry smear about 15 minutes.
- b. Flood with methyl alcohol for two minutes.
- c. Rinse with distilled water.
- d. Flood with crystal violet solution and let stand for one minute.
- e. Wash smear briefly with tap water and drain off excess water.
- f. Flood smear with iodine solution
- g. Wash with tap water and decolorize until solvent flows colorless from the slide.
- h. Wash briefly with tap water.
- i. Counterstain with safranin for 20 seconds.
- j. Wash briefly with tap water, blot dry and examine.

Result: Gram-positive organisms are blue; gram-negative, red.

14. Spore Stain (Wirtz-Conklin)

Prepare smear on slide as above. Flood entire slide with 5 percent aqueous malachite green.

Steam for three to six minutes and rinse under running tap water. Counterstain with 0.5 percent aqueous safranin for 30 seconds.

Results: Spores are seen as green spherules in red stain rods or with red stained debris

15. Gelmsa stain

Remove blood or other tissue and quickly make smear on slide. Air dry. Fix the film with methyl alcohol for 30 seconds. Apply dilute stain for ten minutes. Rinse with distilled water and air dry.

16. Acid-fast stain (Gugol adaptation of Ziehl-Neelsen technique)

Materials

Stain impregnatead paper strips (The Gugol Stain Co., 43-50 11th St., Long Island City, NY 11101)

20 percent and 100 percent solutions of reagent grade methanol.

Procedure:

- a. Heat fix smears
- b. Dip Carbol-Fuchsin strip in 20 percent methanol.
- c. Place on top of specimen for three minutes, remove, rinse with water.
- d. Decolorize and counterstain with second strip dipped in 100 percent methanol by covering for two minutes.
- e. Rinse, air dry, examine.

17. Hanging drop

- a. Apply vaseline or water around the depression of the slide.
- b. Using the inoculating loop, aseptically transfer one drop of bacteria to the center of the coverslip. If bacteria are removed from solid media, mix a loop full in a ml of water and then transfer a drop of mixture to coverslip.
- c. Invert the hanging drop slide and center it well over the drop of bacteria. Press down on the edges of the coverslip so the vaseline or water makes a seal.
- d. Quickly and carefully turn the slide right side up so the hanging drop is suspended in the depression.
- e. Observe the organism for motility and morphology.

Motility: motile, non-motile (don't confuse Brownian Movement with motility).

Morphology: Long rods, short rods, cocci, tetrads, etc.

18. Anaerobic growth environment for anaerobic bacteria

Materials include the following:

GASPAK anaerobic jar (BBL Cockeysville Maryland 21030)

Gaspak packet

catalyst

methene blue indicator

Procedure:

Add plates or tube to jar.

Place on Gaspak envelope one anaerobic indicator and a catalyst in the jar.

Add 10 ml of water to Gaspak envelope and clamp on lid.

Hydrogen produced by the packet reacts in the presence of the catalyst to produce an anaerobic atmosphere. CO₂ is produced by the packet also. Incubate for 48 hours.

Bacteriological media available from:

BBL Division of Bioquest, Box 243, Cockysville, MD 21030

Difco Laboratories, Detroit, Michigan

Other techniques are employed in Diagnostic Laboratories. Gram and other staining is used in conjunction with histological preparation. Equipment that measures fatty acid profiles is also used to quickly differentiate pure cultures of bacteria.

Virological

Light microscopy. Many of the known crustacean viruses belong to the occluded type, their variously shaped occlusions being visible with aid of a light microscope. Several staining procedures may be used to enhance visibility if the occlusions but in acute infection, this is unnecessary to the trained eye. In the case of carrier animals, the chances for detection are related to the time utilized in examination and proper selection of tissues expected to contain viral units.

The advantages of light microscopy are that direct observation of viruses is possible and a result is obtained quickly. The disadvantages are that viruses cannot be detected beyond limits of magnification and one can easily overlook very light infections in large animals.

Procedure consists of making wet mounts of suspect tissues and subjecting them to microscopical examination.

Open shrimp so as to expose the digestive gland and with clean forceps tear back the covering tissue (capsule) of gland, exposing internal tissues. Remove several small internal portions of the digestive gland and intestine and place each on a slide. Quickly place a coverslip onto tissue fragment. With a clean blunt instrument press the coverslip until the tissue is thin enough under the cover slip for detailed cellular observation. Examine for occlusions. The occlusions of *Baculovirus penaei* are tetrahedral or pyramidal in three dimensional form. Other occluded virus may have other shapes. Use high-dry magnification (400 to 600X) or oil immersion (500 to 1000X) and look for characteristic shapes.

It should be maintained that viruses infecting the hepatopancreas are passed out of the animals via the feces. Occlusions can be detected sometimes by examination of feces acquired directly from the animal or from the water in the form of fecal casts.

Serology. Fluorescent antibody procedures have been developed for detection of baculovirus presence in insects. The same commercially available labeled antibodies will also react with crustacean baculoviruses. This technique is likely to assume widespread practical application in laboratories with access to a fluorescent microscope. Laboratory research with crustacea has also developed techniques for fluorescent antibody and ELISA.

Histological changes in host. Detection of the presence of viruses is sometimes based on histological signs

known to be produced by viruses. A common sign is the occurrence of "occlusions" observed in tissue cells. In contrast to the distinct viral units of occluded viruses mentioned above, these occlusions are unusual structures of and within the host cell. Occlusions may occur within the nucleus or cytoplasm of affected cells and possess particular staining characteristics. If occlusions are present in a susceptible animal then this sign is taken as presumptive evidence if virus presence. The procedures of this technique are briefly as follows: Tissues of suspect animals are preserved, embedded, sectioned with microtome and appropriately stained. A positive result consists of finding occlusions with light microscope. Embedding, sectioning and staining follow standard procedures. Preservation (fixation) procedures requires special consideration. Samples should be fixed in a manner that the fixative can readily penetrate important organs. Fixative may be injected or better, bodies may be cut open or halved. If cut portions are divided, subsequent handling should be conducted so as to avoid confusion of identity between shrimps. Two commonly used fixatives are:

Davidson's Solution

3 parts ethyl alcohol

2 parts formalin

1 part glacial acetic acid

(add acid last or at time of fixation)

Buffered neutral formalin solution

1 part formalin (37 percent formaldehyde solution)

9 parts water

4 grams sodium phosphate, monobasic, monohydrate

6.5 grams sodium phosphate, dibasic, anhydrous

For marine forms use seawater from source of capture.

In cases where animals are inapparent carriers of the virus, a virus may be demonstrated by exposing (i.e., feeding or injection) appropriate life stages of highly susceptible animals and waiting (i.e., a month) for development of histological signs. If inclusions are then found, the test is considered positive for virus presence. If no inclusions are noted, animals are considered either virus-free or else the test failed to detect the presence of virus. In the later case additional tests could be conducted. The advantages of this test are that it serves to demonstrate viral pathology of viruses too small for light microscopy and are in lieu of tissue culture techniques which are yet to be developed. Another advantage is that it has the potential for detection in carriers. Disadvantages are that for carriers, a result takes a long time to produce, susceptible live animals of proper size are required, and if not confirmed by electron microscopy then the result is based on only signs. The application of feeding/histopathology (viral enhancement) method is well suited for attempts at establishing virus free stocks. It is less functional in routine diagnosis.

Electron Microscopy with Negative Staining. The main advantage of this technique is the capability to directly observe even the smallest virus. Another advantage is that it provides a quick result. A limitation is that it is best used for animals with acute virus disease rather than carrier animals. The procedure demands the occurrence of advanced viral damage so as to give a threshold presence of one million virus particles per cubic

centimeter. The general procedure is as follows: Grind tissue into a suspendable mass. Suspend in three parts water/one part tissue to a total volume of approximately 15 milliliters. Centrifuge at 1000 G for 30 minutes (=3000 rpm). Remove five milliliters of supernatant and ultracentrifuge at 70,000 G for one hour. The resulting pellet is resuspended in 0.1 milliliter water (two drops). A mixture is then made of one milliliter water, 0.2 milliliter (four drops) of phosphotungstic acid, one drop bovine serum albumin, and one drop sample. This mixture is then put into an all glass nebulizer and atomized on a coated grid. Material is viewed directly on the grid with electron microscope. Transmission electron microscopy after fixation, embedding and sectioning will also demonstrate virus particles but the procedure is too involved and costly for routine diagnosis.

Cell (Tissue) Culture. Cell culture basically consists of isolating living cells from an animal and placing them into a sterile medium that will support their growth. Virus detection in routine cell culture work consists of adding virus suspect material to the cell culture and watching for damage. Such virological examination relies on established "cell lines" which are known to be susceptible to a particular virus. Established cell lines are cell cultures that have been passed from growth vessel to growth vessel 50 times, a process that takes at least two years to complete. Some fish cell lines are now 20 years old. The initial successful attempts at passing cells from vessel to vessel are called "primary cell cultures." Primary cultures may be of some benefit in detection of virus even though their life span is highly unpredictable.

Cell culture is the basis for detection of mammal and fish viruses. Procedures are not well established for crustacean cell culture. No cell lines have been developed but there has been some success in starting primary cultures. (Chen, S.N. and G.H. Kou 1989, *Journal of Fish Disease*. 12:73-76). Cell lines from non-crustacean animals have been challenged with crustacean viruses but have not proved usable.

Rickettsia/Chlamidia detection

There is limited knowledge of this group of organisms or their importance. Members of the group are sometimes found in histological sections of tissues. They form obvious masses in tissues (especially hepatopancreas). Because of their small individual size observation by electron microscopy is needed for confirmation.

Fungal

Fungus samples may be scraped or cut from foci of invasion. Wet mounts are made and structure and fruiting bodies examined. Identification can often be made on this basis. The use of special stains such as Grocott's is useful both in tissue squashes and on histological sections. For further investigation fungus may be isolated similarly as bacteria and grown on petri dishes containing suitable mycological medium.

Sabouraud dextrose agar.

dehydrated sabouraud dextrose agar37.0 gm
distilled water500.0 ml
(plus salt if marine)

Option: the above plus 200 mg/l streptomycin sulfate and

200 u/ml penicillin G for inhibition of bacterial growth.

Protozoological

Use scissors to clip off portions of the body that are thin and transparent (pleopods, edges, of uropods, etc.). Place the clipped portion on the slide and cover with a drop of holding water (or water with appropriate salinity). Prepare a wet mount by touching the edge of the drop with a coverslip and lowering it onto the dissected specimen in a manner that prevents entrapment of bubbles. Examine with a microscope for protozoa such as *Zoothamnium*, *Acineta*, *Lagenophrys*, and *Epistylis*. Note relative abundance of protozoa.

Use scissors to clip off portion of carapace that covers the gills. Clip off a small portion of gill and prepare for examination as described above. Note kinds and abundance of protozoa. Also remove a portion of the gill near the bailer and check for apostome cysts.

Remove blood as described above and check for protozoa. Also examine blood in situ or as it exudes from removed appendages or gills. Special staining or impregnation methods are required to properly identify species of most protozoa affixed to cuticular surface or invading the blood.

Open the specimen as described above and examine the digestive tract. Note abundance of gregarines and location of peculiar concentrations.

Dissect specimen as indicated above paying particular attention to peculiar coloration in tissues. Remove portions of such tissues with sharp forceps and prepare wet mount. Apply gentle pressure to expose spores. Note number of spores in spore groupings, structure of individual spores and tissue from which they were removed.

Helminthological (Flukes, Acanthocephalans, and Tapeworms)

Check particular body locations that handbooks give as preferred by worms. Note abundance of worms or their cysts. Identification will often require mounting and staining. Locate a worm and release it by rupturing the cyst carefully with fine needles. Prepare a wet mount of the worm so as to catch it in an extended position. Light pressure on the coverglass will ensure that tapeworm scoleces and acanthocephalan proboscises are extended and that flukes are flattened. Acanthocephala kept in tap water for a few hours to several days will retain everted proboscises. With a paper (Kleenex) remove most of the water from under the cover-glass. Immediately flood with a hot but not boiling 5 percent formalin. After a minute release the pressure. Place slide with worm into a dish of alcohol so as to cover the entire preparation. Cover dish and wait until the next day before proceeding. By the next day the worm will be adhered to either the coverglass or the slide. Whichever the case, conduct staining thereon. The worm will often detach completely. If so, remount at end of staining process.

Staining may be by procedures given in various parasitology manuals.

The one that follows is commonly used:

1. Add formalin-preserved worms only into 35 percent ethyl alcohol-ETOH).

2. After about five minutes draw off 35 percent ETOH and replace with 50 percent ETOH.
3. After five minutes draw off 50 percent alcohol and replace with stain that is diluted with at least an equal volume of 50 percent alcohol.
4. About 15 minutes is usually enough time to slightly overstain.
5. Draw off stain and replace with 1 percent HCL in 70 percent alcohol to destain.
6. Examine frequently and destain until light pink.
7. Draw off acid 70 percent and replace with 100 percent ETOH for five minutes.
8. Repeat procedure to remove trace acid ETOH.
9. Draw off about 1/2 of the 100 percent and replace it with clearing agent (terpineol).
10. Draw off and replace with pure clearing agent.
11. After a few minutes remove clearing agent and mount in Permunt on slide and cover with coverglass.

Stain — Semichon's carmine - add one volume of glacial acetic acid slowly with mixing to an equal amount of distilled water. Add carmine powder in excess of that with dissolves immediately and heat to 95 to 100 degrees C for 15 minutes. Cool and filter. The filtrate is the stock stain which is diluted with at least an equal amount of 70 percent alcohol before use.

Acanthocephalans have a resistant cuticle. A small puncture made with a fine needle prior to staining will allow stain to reach the internal organs.

Nematodes are difficult to stain but can be identified without staining. Clearing is required, however, because the cuticle usually interferes with examination of internal structures. Place hot 70 percent alcohol preserved specimen on a slide and remove most of the liquid with a Kleenex. Examine in Hoyer's solution or lacto-phenol. To prevent specimen collapse add lacto-phenol slowly by portions. Hoyer's dries to give a permanent mount.

Hoyer's Solution:		Lacto-phenol:	
Distilled water	50 ml	Glycerine	2 parts
Gum Arabic flakes	30 ml	Distilled water	1 part
Chloral hydrate	300 gm	Phenol, melted	1 part
		crystals	
Glycerine	30 ml	Lactic acid	1 part
Mix in order at room temperature.			

Specific Pathogen Free (SPF) Shrimp

SPF shrimp were developed in 1989 through the U.S. Marine Shrimp Farming Program (The Gulf Coast Research Laboratory Consortium (USDA) and the Oceanic Institute, Hawaii) efforts. Commercial suppliers (who must be certified by the USDA's Shrimp Consortium) now offer SPF shrimp.

Test results at Harlingen Shrimp Farm in Texas, (Presentation at Texas Aquaculture Association meeting, 1992 by Dr. Frank Castille of Texas A&M University) have been very favorable with SPF animals. Growth and survival of SPFP *vannamei* were better than non-SPF animals. Results from Ecuador (personal communication with Mr. A. Perez) also indicate increased growth and survival with SPF shrimp obtained from a Texas supplier.

Until recently, SPF animals (adults) were available only through the U.S. Shrimp Consortium and the Oce-

anic Institute. These animals were only supplied to certified U.S. producers. Now that the shrimp (both brood shrimp and larvae) are available from certified commercial suppliers (such as Amorient Aquafarm Inc., Hawaii and Harlingen Shrimp Farm, Texas) any producer may obtain SPF animals. SPF animals should assist in the control of the IHFN, HPV and B-P type viruses as well as other pathogens. Obtaining SPF animals does not guarantee disease-free animals. The producer must also practice good management procedures and employ strict precautions against disease introduction to SPF animals. Good nutrition is important in maintaining shrimp health. The producer must try to keep the environmental conditions optimum, keep stress minimized, continually monitor the shrimp's health, and take immediate action if a health problem is detected.

Acknowledgments

Material for this chapter was provided through publications of Dr. Don Lightner and others and is used with his permission. Lightner acknowledges R.M. Redman, W. Randall and T.A. Bell for their assistance in assembling the review, which was published by the Aquaculture Department Southeast Asian Fisheries Development Center in the *Proceedings of the First International Conference on the Culture of Penaeid Prawns/Shrimp*. Parts of it are used with the written permission of the Center, and many thanks are extended for this cooperation.

Dr. Lightner also acknowledges grants from the Hawaii Aquaculture Development Program and the National Sea Grant Program, and thanks Texas A&M University, National Marine Fisheries Center, Continental Fisheries Ltd., The Marine Research Division of the Alabama Department of Conservation and Natural Resources, as well as others too numerous to list for submission of preserved samples. Updates and the methods of routine examination were provided by Dr. S.K. Johnson, Department of Wildlife and Fisheries Sciences, Texas A&M University. Material compiled for the Shrimp Toxicology section was provided by Couch (1979), with written permission from Tod Rupp, Academic Press, permissions department, Orlando, Florida. and the Academic Press, New York.

Selected Recent Shrimp Toxicology and Disease References

1. Abu-Hakima, R., 1984. Preliminary observations of the effects of *Epipemaeon elegans* (Isopoda: Bopyridae) on the reproduction of *Penaeus semisulcatus* (de Haan) (Decapoda: Penaeidae). *Int. J. Invertebr. Repro.*, 7:51-62.
2. Akamine, Y. and J.L. Moores, 1989. A preliminary study on disinfection methods of penaeid-shrimp hatcheries contaminated by *Baculovirus penaei*. *Abstract WAS Conference*. Feb. 1989, Los Angeles, CA.
3. Akiyama, D.M., J.A. Brock and S.R. Haley, 1982. Idiopathic muscle necrosis in the cultured freshwater prawn, *Macrobrachium rosenbergii*. *VM/SAC*, 1119-1121.

4. Alcaraz, M. and F. Sanda, 1981. Oxygen consumption by *Nephrops norvegicus* (L.) (Crustacea, Decapoda) in relationship to its moulting cycle. *J. Exp. Mar. Biol. Ecol.*, 54:113-118.
5. Amos, K.H., 1985. Procedures for the detection and identification of certain fish pathogens (The Fish Health Blue Book). Third Edition. Spec. Publ. Amer. Fish. Soc. 114p.
6. Anderson, I.G., M. Shariff and G. Nash, 1989. A hepatopancreatic microsporidian in pond-reared tiger shrimp, *Penaeus monodon*, from Malaysia. *J. Invert. Pathol.*, 53:278-280.
7. Batchelder, T.L., H.C. Alexander and W.M. McCarty, 1980. Acute fish toxicity of the Versene family of chelating agents. *Bull. Environmental Contam. Toxicol.* 24: 543-549.
8. Baticados, C.L., R.M. Coloso and R.C. Duremidez, 1986. Studies on the chronic soft-shell syndrome in the tiger prawn, *Penaeus monodon* (Fabricius), from brackish water ponds. *Aquaculture*, 56:271-285.
9. Bautista, M.N., 1986. The response of *Penaeus monodon* juveniles to varying protein/energy ratios in test diets. *Aquaculture*, 53:229-242
10. Bell, T.A. and D.V. Lightner, 1988. A handbook of normal penaeid shrimp histology. *World Aquaculture Society*, Baton Rouge, Louisiana, 114 pages.
11. Bell, T.A. and D.V. Lightner, 1987. IHHN disease of *Penaeus stylirostris*: Effects of shrimp size on disease expression. *J. Fish Diseases*, 10:165-170.
12. Bell, T.A. and D.V. Lightner, 1983. The penaeid shrimp species affected and known geographic distribution of IHHN virus. *First Biennial Conference on Warm Water Aquaculture - Crustacea*. Brigham Young Univ. (Hawaii Campus), AVI Press, Westport, CT.
13. Bland, C.E., D.G. Ruch, B.R. Salsler and D.V. Lightner, 1976. Chemical control of *Lagenidium*, a fungal pathogen of marine crustacea. *University of North Carolina Sea Grant Publication*, UNC-SG-76-02, 38pp.
14. Bland, C.E., 1975. Fungal diseases of marine crustacea. *Proceedings of the Third US-Japan Meeting on Aquaculture at Tokyo*, October, 1974, 41-48.
15. Bonami, J.R., M. Brehelin and M. Weppe, 1986. Observations sur la pathogenicite, La transmission et la resistance du MBV (*monodon baculovirus*). *Proc. Ind. International Colloquium on Pathology in Marine Aquaculture*, Porto, Portugal, 7-11 Sept. ,1986, p. 119.
16. Bonami, J.R., 1976. Viruses from crustaceans and annelids: Our state of knowledge. *Proc. Int. Collo. Invertebr. Pathol.*, 1:20-23.
17. Bovo, G., G. Ceschia, G. Giorgetti and M. Vanelli, 1984. Isolation of an IPN-like virus from adult kuruma shrimp *Penaeus japonicus*. *Bull. Eur. Assn. Fish Pathol.*, 4:21.
18. Brisson, S., 1985. Gas-bubble disease observed in pink shrimps, *Penaeus brasiliensis* and *Penaeus paulensis*. *Aquaculture*, 47:97-99.
19. Brock, J.A., 1988. Rickettsial infection of penaeid shrimp. *In: C. Sindermann and D. Lightner (eds.) Disease diagnosis and control in North American aquaculture*. Elsevier, Amsterdam, pgs. 38-41.
20. Brock, J.A., L.K. Nakagawa, T. Hayashi, S. Teruya and H. Van Campen, 1986. Hepatopancreatic rickettsial infection of the penaeid shrimp, *Penaeus marginatus* (Randall), from Hawaii. *J. Fish Disease*. 9:353-355.
21. Brock, J.A., D.V. Lightner and T.A. Bell, 1983. A review of four viral (BP, MBV, BMN and IHNV) diseases of penaeid shrimp with particular reference to clinical significance, Council for the Exploration of the Sea C.M. 1983/Gen:10/Mini-Symposium.
22. Bueno, S.L., R. Nascimento and I. Nascimento, 1989. *Baculovirus penaei* infection in *P. sublitis*: A new host and a new geographical range of the disease, presented WAS meeting, Feb. 1989, Los Angeles, CA., USA.
23. Castille, F.L., and A.L. Lawrence, 1981. The effects of EDTA (ethylenedinitrotetracetic acid) on the survival and development of shrimp nauplii (*Penaeus stylirostris* Stimpson) and the interactions of EDTA with the toxicities of cadmium, calcium and phenol. *J. World of Mariculture. Soc.* 12: 292-304.
24. Castille, F.L. and A.L. Lawrence, 1986. The toxicity of erythromycin, minocycline, malachite green and formalin to nauplii of the shrimp *P. stylirostris*. *WAS* 17:(1-4): p. 13-18.
25. Castille, F.L. and A.L. Lawrence, 1981. A comparison of the osmotic sodium and chloride concentrations between the urine and hemolymph of *P. setiferus* and *P. stylirostris*. *Comparative Bio. Chem. and Physio.* 70A:525-528.
26. Chen, D., X. Liu, Y. Yu, Z. Yang, T. Xiao and Q. Wang, in press. The Vibrio disease of penaeid shrimp in the larval rearing systems and its comprehensive preventions. *Ann. Rept. Open Lab. Acad. Sinica Inst. Oceanol. Exper. Mar. Biol.*, 1.
27. Chen, H.C., 1981. Some abnormal aspects of the prawn *Palaemon elegans* exposed to heavy metals. *Proc. R.O.C.-U.S. Coop. Sci. Seminar on Fish Disease* 3:75-83. National Sci Council, R.O.C.
28. Chen, J.C. 1983. Management of water quality. Chieu-Ta Book Co., Taipei, Taiwan.
29. Chen, J.C., and P.C. Liu, 1987. Accumulation of heavy metals in the nauplii of *Artemia*. *J. World Mariculture Soc.* 18: 84-93.
30. Chen, J.C., Y.Y. Ting, H. Lin and T.C. Lian, 1985. Heavy metal concentrations in sea water from grass-prawn hatcheries and the coast of Taiwan. *J. World Maricul. Soc.*, 16:316-332.
31. Chen, L., 1988. The effect and application of Wu Bei Zi to cure shrimp fungus disease (Dui Xia). *China Fisheries*, 6:12 (in Chinese).
32. Chen, S.N. and G.H. Kou, 1989. Infection of cultured cells from the lymphoid organ of *P. monodon* by monodon-type baculovirus (MBV). *J. Fish Diseases*, 12:73-76.
33. Cheng, W.W. and W.Y. Tseng, 1982. A parasite, *Epipenaeon ingens* (Nobili) of the commercial shrimp. *Penaeus semisulcatus* (de Haan) in Hong Kong. *Introduction of Taxonomy*, B. Morton (ed.), 1:393-399.
34. Chinnayra, B., 1971. Effect of heavy metals on oxygen consumption by the shrimp *Caridina rajadhardi* (Bouvier). *Indian J. Exp. Biol.* 9: 277 - 278.
35. Chong, Y.C. and H. Loh, 1984. Hepatopancreas

- chlamydial and parvoviral infections of farmed marine shrimp in Singapore. *Singapore Vet. Jnl.* 9:51-56.
36. Chu, S.H., 1976. Note on the fungus disease of the pond-cultured grass prawn *Penaeus monodon*. *Jour. Fish. Soc. Taiwan*, 4:31-35.
 37. Cipriani, G.R., R.S. Wheeler and R.K. Sizemore, 1980. Characterization of brown-spot disease of Gulf Coast shrimp. *J. Invertebr. Pathol.*, 36:255.
 38. Clark, J.V., 1986. Inhibition of molting in *Penaeus semisulcatus* (de Haan) by long-term hypoxia. *Aquaculture*, 52:253-254.
 39. Colorni, A., T. Samocha and B. Colorni, 1987. Pathogenic viruses introduced into Israeli mariculture systems by imported penaeid shrimp. *Bamidgeh*, 39:21-28.
 40. Corkern, C.C., 1978. A larval cyclophyllidean (*Cestoda: Trypanorhyncha*). *J. Parasitol.* 45:490.
 41. Corkern, C.C., 1977. Protozoan and metazoan symbiots of natural and maricultured populations of commercial shrimp from the northwestern coast of the Gulf of Mexico. Dissertation Texas A&M University, 167 pages.
 42. Correa, M., 1987. Physiological effects of metal toxicity on the tropical freshwater shrimp *Macrobrachium carcinus* (Linneo, 1758) *Environmental Pollution*, 45: 149 - 155.
 43. Couch, J.A., 1983. Diseases caused by protozoa. In: Provenzano, Jr., A.J. (ed.), *Pathobiology. The Biology of Crustacea*, p. 79-111.
 44. Couch, J.A., 1981. Viral diseases of invertebrates other than insects. In: *Pathogenesis of invertebrate microbial diseases* (E.W. Davidson, ed.), pp. 127-160. Allanheld (Osmum Publ.) Totowa, New Jersey.
 45. Couch, J.A., 1979. Shrimps (*Arthropoda: Crustacea: Penaeidae*). Chapter 7 In *pollution ecology of estuarine invertebrates*. L.W. Hart and S.H. Fuller, (eds). Academic Press. N.Y. 1979, 406 pages.
 46. Couch, J.A., 1978. Diseases, parasites and toxic responses of commercial penaeid shrimp of the Gulf of Mexico and South Atlantic. *Fish. Bull*, 76:1-44.
 47. Couch, J.A. and L. Courtney, 1977. Interaction of chemical pollutants and virus in a crustacean: A novel bioassay system. *Ann. N.Y. Acad. Sci.*, 298:497-504.
 48. Couch, J.A., M.D. Summers and L. Courtney, 1975. Environmental significance of *Baculovirus* infections in estuarine marine shrimp. *Ann. N.Y. Acad. Sci.*, 266:528-536.
 49. Couch, J.A., 1974a. Free and occluded virus, similar to *Baculovirus*, in hepatopancreas of pink shrimp. *Nature* 247:229-231.
 50. Couch, J.A., 1974b. An enzootic nuclear polyhydroxide virus of pink shrimp: ultrastructure, prevalence, and enhancement. *Jrnl. Invert. Path.* 24:311-331.
 51. Dall, W. and D.M. Smith, 1986. Oxygen consumption and ammonia-N excretion in fed and starved tiger prawns, *Penaeus esculentus* (Haswell). *Aquaculture*, 55:23-33.
 52. Del Ramo, J. Diaz-Mayans, A. Torreblanca, and A. Nunez, 1987. Effects of temperature on the acute toxicity of heavy metals (Cr, Cd and Hg) to the freshwater crayfish, *Procambarus clarkii* (Girard). *Bull. Environm. Contam. Toxicol.* 38: 736 - 741.
 53. Deardorff, T.L. and R.M. Overstreet, 1981. Larval *Hysterothylacium* (*Thynnascaris*) (Nematoda: Anisakidae) from fishes and invertebrates in the Gulf of Mexico. *Proc. Helminthol. Soc. Wash.*, 48:113-126.
 54. Deardorff, T.L. and R.M. Overstreet, 1981. Review of *Hysterothylacium* and *Iheringascaris* (both previously *Thynnascaris*) (Nematoda: Anisakidae) from the northern Gulf of Mexico. *Proc. Biol. Soc. Wash.*, 93:1035-1079.
 55. Diamant, A., A. Colorni, 1987. Viral infections in penaeid shrimp in Israel and use of acridine orange fluorescence as a rapid diagnostic method. *E.A.F.P. 3rd Inter. Conference, Bergen (Norway), Aug. 31-Sept. 3, 1987* (Abstract).
 56. Doughtie D.G. and K.R. Rao, 1983. Ultrastructural and histological study of degenerative changes leading to black gills in grass shrimp exposed to a dithiocarbamate biocide. *J. Invert. Pathol.* 41:33-50.
 57. Doughtie, D.G. and K.R. Rao, 1983. Ultrastructural and histological study of degenerative changes in the antennal glands, hepatopancreas, and midgut of grass shrimp exposed to two dithiocarbamate biocides. *J. Invertebr. Pathol.*, 41:281-300.
 58. Doughtie, D.G., P.J. Conklin and K.R. Rao, 1983. Cuticular lesions induced in grass shrimp exposed to hexavalent chromium. *J. Invertebr. Pathol.*, 42:249-258.
 59. Dunlop, S., and G. Chapman, 1981. Detoxication of zinc and cadmium by the freshwater protozoon *Tetrahymena pyriformis*. Growth experiments and ultrastructural studies on sequestration of heavy metals. *Environ. Res.* 24: 264 - 274.
 60. Dykova, I. and J. Lom, 1988. A new haplosporean infecting the hepato-pancreas in the penaeid shrimp, *Penaeus vannamei*. *J. Fish Diseases*, 11:15-22.
 61. Egusa, S., Y. Takahashi, T. Itami and K. Momovama, 1988. Histopathology of vibriosis in the Kuruma prawn, *Penaeus japonicus* (Bate). *Fish Pathology*, 23:59-65.
 62. El-Musa, M.M. Al-Hossaimi and A.R. Abdul-Ghaffar, 1981. Infestation of the shrimp *Penaeus semisulcatus* (DeHaan) by the bopyrid *Epipenaeon elegans* (Chopra) in Kuwait. *Kuwait Inst. Sci. Res. Tech. Rep.*, 369:1-22.
 63. Engel, D.W., and B.A. Fowler, 1979. Factors influencing cadmium accumulation and its toxicity to marine organisms. *Environ. Health Perspectives* 28: 81-88.
 64. Engel D.W., and W.G. Sunca 1979. Toxicity of cupric ion to eggs of the spot *Leiostomus xanthurus* and the Atlantic silverside *Menidia menidia*. *Mar. Biol.* 50: 121 - 126.
 65. Environmental Agency of Japan. 1972. Water pollution control in Japan. 1:54. Printing bureau, Min of Finance. Tokyo, Japan
 66. Evans, M.L. 1980. Copper accumulation in the cray-

- fish (*Orconectes rusticus*). **Bull. Environm. Contam. Toxicol.** 24: 916 - 920.
67. FAO., 1977. Control of the spread of major communicable fish diseases. **FAO Fisheries Report**, No. 192. FID/R192 (EN). 36p.
 68. Foster, C.A., C.A. Farley and P.T. Johnson, 1981. Virus-like particles in cardiac cells of the brown shrimp, *Penaeus aztecus*. (Ives). **J. Submicrosc. Cytol.** 13:723-726.
 69. Foster, P.L., and F.M.M. Morel 1982. Reversal and cadmium toxicity in a diatom: an interaction between cadmium activity and iron. **Limmol. Oceanogr.** 27: 745 - 752.
 70. Fusco, A.C. and R.M. Overstreet, 1978. *Spirocamallanus cricotus* sp. n. and *S. halitrophus* sp. n. (Nematoda: Camallanidea) from fishes in the northern Gulf of Mexico. **J. Parasitol.**, 64:239-244.
 71. Gardiner, J., 1976. Complexation of trace metals by ethylenediaminetetracetic acid (EDTA) in natural waters. **Water Research** 10: 507 - 514.
 72. Halcrow, K., 1988. Absence of epicuticle from the repair cuticle produced by four malacostracan crustaceans. **J. Crustacean Biol.**, 8:346-354.
 73. Hasson, D.W., 1987. Sources of bacterial contamination in a penaeid shrimp hatchery. **Jnl. WAS** 18(1):34A. **Aquaculture Communique's** #134.
 74. Hatai, K., B.Z. Bian, C.A. Baticados and S. Egusa, 1980. Studies on fungal diseases in crustaceans. II. *Haliphthoros philippensis* sp. nov. isolated from cultivated larvae of the jumbo-tiger prawn *Penaeus monodon*. **Transactions of the Mycological Society of Japan**, 21:47-55.
 75. Holwerda, D.A., J. Hemelraad, P.R. Veenhof and D. I. Zandee, 1988. Cadmium accumulation and depuration in *Anodonta anatina* exposed to cadmium chloride or cadmium-EDTA complex. **Bull. Environ. Contam. Toxicol.** 40: 373- 380.
 76. Hose, J.E., D.V. Lightner, R.M. Redman and D.A. Danald, 1984. Observations on the pathogenesis of the imperfect fungus, *Fusarium solani*, in the California brown shrimp, *Penaeus californiensis*. **J. Invertebr. Pathol.**, 44:292-303.
 77. Johnson, P.T., 1984. Viral diseases of marine invertebrates. **Helgolander Meeresunters**, 37:65-98.
 78. Johnson, P.T., 1983. Diseases caused by viruses, rickettsiae, bacteria, and fungi. *In: Provenzano, A.J. (ed.) The biology of Crustacea*, Vol. 6, Academic Press, New York, p. 1-78.
 79. Johnson, S.K., 1989. **Handbook of shrimp diseases**. Texas A&M University Sea Grant Publication TAMU-SG-90-601.
 80. Johnson, S.K., 1989. Guidelines for the examination of biological disease agents in marine and freshwater shrimp (unpublished handout).
 81. Johnson, S.K., 1978. **Handbook of Shrimp Diseases**. Texas A&M University Sea Grant Publication TAMU-SG-75-603, 23 pages.
 82. Johnson, S.K., 1975. Cramped condition in pond-reared shrimp. Texas A&M University Fish Disease **Diagnostic Laboratory Leaflet No. FDDL-S6**.
 83. Johnson, S.K., 1974. Ectocommensals and parasites of shrimp from Texas rearing ponds. Texas A&M University Sea Grant College Publication No. TAMU-SG-74-207, 19 pages.
 84. Johnston, R., 1964. Sea water the natural medium of phytoplankton. II. Trace metals and chelation, and general discussion. **J. Mar. Biol. Ass. U.K.** 44: 87 - 109.
 85. Kjos, D.J., R.R. Furgeason and L.L. Edwards, 1975. Ozone treatment of potable water to remove iron and maganese. **Inter. Ozone Institute, Waterbury, Conn. (Symposium Proceedings pages 194-203)**.
 86. Kumaraguru, A. E., D. Selvi and V.k. Venugopalan, 1980. Copper toxocity to an estuarine clam (*Meretix casta*). **Bull. Environm. Contam. Toxicol.** 24: 853 - 857.
 87. Lawrence, A.L., J. Fox and F.L. Castille, 1981. Decreased toxicity of copper and manganese ions to shrimp nauplii (*Penaeus stylirostris*, Stimpson) in the presence of EDTA. **J. World Mariculture Soc.** 12(1): 271-280.
 88. Leong, J.K. and C.T. Fontaine, 1979. Experimental assessment of the virulence of four species of *Vibrio* bacteria in penaeid shrimp. pp. 109-132. *In: Lewis, D.L. and J.K. Leong (eds.) Proceedings of the Second Biennial Crustacean Health Workshop*. Texas A&M University Sea Grant Program Publication No. TAMU-SG-79-114.
 89. Lester, R.J.G., A. Doubrovsky, J.L. Paynter, S.K. Sambhi, and J.G. Atherton, 1987. Light and electron-microscopic evidence of baculovirus infection in the prawn *P. plebejus*. **Diseases of Aquatic Organisms** 3:159-165.
 90. Li, Y.H., Bischoff, J. and G. Maathieu. 1969. **Earth Plan Sci. Letter** 7: 265.
 91. Lightner, D.V. and R.M. Redman, in press. Host, geographic range and diagnostic procedures for the penaeid-virus disease of concern to shrimp culturists in the Americas. *In: W. Dougherty (ed.), Proc. of a Symposium on the Frontiers of Shrimp Research*, Elsevier. New York.
 92. Lightner, D.V., R.M. Redman, T.A. Bell, and R.B. Thurman, in press. Geographic dispersion of the viruses IHHN, MBV and HPV as a consequence of transfers and introductions of penaeid shrimp to new regions for aquaculture purposes. *In: A symposium on human influences on aquatic ecosystems held at the 1989 World Aquaculture Society meeting in Los Angeles, CA*.
 93. Lightner, D.V., R.M. Redman, and E.A. Almada Ruiz, 1988. BP in *P. stylirostris* cultured in Mexico: unique cytopathology and a new geographic record. **Jrnl. Invert. Path.** 51:137-139.
 94. Lightner, D.V., 1988. Diseases of cultured penaeid shrimp and prawns. pp. 8-127. *In: C.J. Sindermann and D.V. Lightner, (eds.), Disease diagnosis and control in North American aquaculture*. Elsevier, Amsterdam.
 95. Lightner, D.V. and T.A. Bell, 1987. IHHN disease of *Penaeus stylirostris*: effects of shrimp size on disease expression. **J. Fish Diseases.**, 10:165-170.
 96. Lightner, D.V., R.M. Redman and T.A. Bell, 1987.

- Diagnostic methods currently in use for the penaeid-virus diseases of potential concern to shrimp culturists in Hawaii. *Jnl. WAS* 18(1):34A. Aquaculture Communique's #135.
97. Lightner, D.V. and R.M. Redman, 1986. A probable *Mycobacterium* sp. infection of the marine shrimp *Penaeus vannamei* (Crustacea: Decapoda). *J. Fish Diseases*, 9:357-359.
 98. Lightner, D.V., R.P. Hedrick, J.L. Fryer, S.N. Chen, I.C. Liao, and G.H. Kou, 1987. A survey of cultured penaeid shrimp in Taiwan for viral and other important diseases. *Fish Path.* 22:127-140.
 99. Lightner, D.V. and R.M. Redman, 1985. A parvo-like virus disease of penaeid shrimp. *J. Invertebr. Pathol.*, 45:47-53.
 100. Lightner, D.V., R.M. Redman, T.A. Bell and J.A. Brock, 1984. An idiopathic proliferative-disease syndrome of the midgut and ventral nerve in the Kuruma prawn, *Penaeus japonicus* (Bate), cultured in Hawaii. *J. Fish Diseases*, 7:183-191.
 101. Lightner, D.V., 1983. Diseases of cultured penaeid shrimp pp. 289-320. In: J.P. McVey (ed.), *CRC Handbook of Mariculture. Vol. 1 Crustacean Aquaculture*, CRC Press. Boca Raton, FL.
 102. Lightner, D.V., R.M. Redman and T.A. Bell, 1983a. Histopathology and diagnostic methods for IHHN and MBV disease in cultured penaeid shrimp. *Proc. Symposium on Warm Water Aquaculture - Crustacea*. Brigham Young University. Laie, Hawaii, Feb. 9-11, 1983.
 103. Lightner, D.V., R.M. Redman and T.A. Bell, 1983b. Infectious hypodermal and hematopoietic necrosis (IHHN), a newly recognized virus disease of penaeid shrimp. *J. Invertebr. Pathol.*, 42:62-70.
 104. Lightner, D.V., R.M. Redman and T.A. Bell, 1983c. Observations on the geographic distribution, pathogenesis and morphology of the baculovirus from *Penaeus monodon* (Fabricius). *Aquaculture*, 32:209-233.
 105. Lightner, D.V., R.M. Redman, T.A. Bell and J.A. Brock, 1983d. Detection of IHHN virus in *Penaeus stylirostris* and *P. vannamei* imported into Hawaii. *J. World Maric. Soc.*, 14:212-225.
 106. Lightner, D.V., D. Moore and D.A. Donald, 1979. A mycotic disease of cultured penaeid shrimp caused by the fungus *Fusarium solani*. In *Proc. 2nd Biennial Crustacean Health Workshop*, D.H. Lewis and J.K. Leong, (eds.), Texas A&M University Sea Grant Publication No. TAMU-SG-79-114, pp. 137-158.
 107. Lightner, D.V., R.M. Redman, R.R. Williams, L.L. Mohny, J.P.M. Clerx, T.A. Bell and J.A. Brock, 1985. Recent advances in penaeid virus disease investigations. *J. World Aquaculture Soc.*, 16:267-274.
 108. Liu, P.C. and J.C. Chen, 1987. Effects of heavy metals on the hatching rates of brine shrimp *Artemia salina* cysts. *J. World Maricul. Soc.* 18: 78 - 83.
 109. Lovell, R.T., 1984. Microbial toxins in fish feeds. *Aquacult. Mag.*, 10:34.
 110. Manthe, D., R. Malone and H. Perry, 1984. Factors affecting molting success of the blue crab *Callinectes sapidus* (Rathburn) held in closed, recirculating seawater systems. *Abstracts, 1984 Ann. Meeting, National Shellfisheries Assn.*, June 25-28, Tampa, Florida, page 40.
 111. Mark, H.F., J.J. McKetta and D. F. Othmer, 1965. *Kirk-Othmer Encyclopedia of Chemical Technology*, Vol. 6, pp. 21 - 24. Interscience, N.Y.
 112. Mathews, C.P., M. El-Musa, M. Al-Hossaini, M. Samuel and A.R. Abdul Ghaffar, 1988. Infestations of *Epipenaenon elegans* on *Penaeus semisulcatus* and their use as biological tags. *J. Crust. Biol.*, 8:53-62.
 113. McKenney, C.L., and J.M. Neff, 1979. Individual effects and interactions of salinity, temperature, and zinc on larval development of the grass shrimp *Palaemonetes pugio*. I. Survival and developmental duration through metamorphosis. *Marine Biology* 52: 177 - 188.
 114. McLeese, D.W., and S. Ray, 1988. Toxicity of CdCl₂, CdEDTA, CuCl₂, and CuEDTA to marine invertebrates. *Bull Environ. Contam. Toxicol.* 36: 749 - 755.
 115. Medlyn, R.A., 1980. Susceptibility of four geographical strains of adult *Artemia* to *Ptychodiscus brevis* toxin(s). Pages 225-231, in the brine shrimp *Artemia*, Volume I, Morphology, Genetics, Radiobiology, Toxicology. G. Persoone, P. Sorgeloos, O. Roels and E. Jaspers (eds.). Universal Press, Wettern, Belgium, 345. pages.
 116. Momoyama, K. and T. Sano, 1988. A method of experimental infection of Kuruma shrimp larvae, *Penaeus japonicus* (Bate), with baculoviral midgut-gland necrosis (BMN) virus. *J. Fish Dis.*, 11:105-111.
 117. Momoyama, K. and T. Matsuzato, 1987. Muscle necrosis of cultured Kuruma shrimp (*Penaeus japonicus*). *Fish Pathology*, 22:69-75.
 118. Momoyama, K., 1983. Studies on baculoviral midgut-gland necrosis of Kuruma shrimp (*Penaeus japonicus*) - III, presumptive diagnostic techniques. (in Japanese), *Fish Pathology*, 17:263-268.
 119. Momoyama, K., 1981. Studies on infectious midgut-gland necrosis of Kuruma shrimp *Penaeus japonicus* (Bate) - I, occurrence and symptoms. (in Japanese), *Bulletin Yamaguchi Prefectural Naikai Fisheries Experimental Station*, 8:1-11.
 120. Muramoto, S., 1980. Decrease in cadmium concentration in a Cd-contaminated fish by short term exposure to EDTA. *Bull. Environm. Contam. Toxicol.* 25: 828 - 831.
 121. Nash, G., I.G. Anderson and M. Shariff, 1988. Pathological changes in the tiger prawn, *Penaeus monodon* (Fabricius), associated with culture in brackish-water ponds developed from potentially acid sulfate soils. *J. of Fish Diseases*, 11:113-123.
 122. Nash, M. and G. Nash, in press. A reo-like virus observed in the tiger prawn, *P. monodon*, from Malaysia. *Jrnl. of Fish Diseases*.
 123. Nash, M., G. Nash, Anderson and M. Shariff, 1988. A reo-like virus observed in the tiger prawn *P. monodon* from Malaysia. *J. Fish Diseases* 11:531-535.
 124. Nash, G., S. Chinabut and C. Limsuwan, 1987. Idiopathic-muscle necrosis in the freshwater prawn, *Macrobrachium rosenbergii* (de Man), cultured in Thailand. *J. of Fish Diseases*, 10:109-120.
 125. Natarajan, P., 1979. On the occurrence of

- trypanorhynchan plerocercoid in the marine prawn *Penaeus indicus*. *Curr. Res. (India)*, 8:63-64.
126. Nearhos, S.P. and R.J.G. Lester, 1984. New records of Bopyridae (Crustacea: Isopoda: Epicaridea) from Queensland waters. *Mem. Queensl. Mus.*, 21:257-259.
 127. Nearhos, S.P., 1980. Aspects of parasitization of Queensland penaeid prawns by two members of the family Bopyridae (Isopoda: Epicaridea). M. Sc. Qual. Thesis, University of Queensland.
 128. Nishimura, S., T., H. Fukuda and T. Hayashida, 1985. Baculoviral infectivity trials on Kuruma shrimp larvae, *Penaeus japonicus*, of different ages. In: A.E. Ellis (ed.) *Fish and Shellfish Pathology*. Pages 397-403, Academic Press, London.
 129. Nugegoda, D., and P.S. Rainbow, 1988. Effect of a chelating agent (EDTA) on zinc uptake and regulation by *Palaemon elegans* (Crustacea: Decapoda). *J. Mar. Biol. Asso. U.K.* 68: 25 - 40.
 130. Nyhlen, L. and T. Unestam, 1980. Wound reactions and *Apahnomycetes astaci* growth in crayfish cuticle. *J. Invertebr. Pathol.*, 36:187-197.
 131. Overstreet, R.M., 1988. Aquatic pollution problems, Southeastern U.S. coasts: histopathological indicators. *Aquatic Toxicology*, 11:213-239.
 132. Overstreet R.M., K.C. Stuck, R.A. Krol and W.E. Hawkins, 1988. Experimental infections with *Baculovirus penaei* in the white shrimp *Penaeus vannamei* (Crustacea: Decapoda) as a bioassay. *J. World Aquaculture Soc.*, 19:175-187.
 133. Overstreet, R.M., 1983. Metazoan symbionts of crustaceans. In: A.J. Provenzano (ed.), *Pathobiology. The Biology of Crustacea*, p. 155-250. Academic Press, N.Y.
 134. Overstreet, R.M. and S. Safford, 1980. Diatoms in the gills of the commercial white shrimp. *Gulf Research Reports*, 6:421-422.
 135. Overstreet, R.M. and T. Van Devender, 1978. Implication of an environmentally-induced hematoma in commercial shrimp. *J. Invertebr. Pathol.*, 31:234-238.
 136. Owens, L., 1987. A checklist of metazoan parasites from Natantia (excluding the crustacean parasites of the Caridea). *J. Shellfish Research*, 6:117-124.
 137. Owens, L., 1985. *Polypocephalus* sp. (Cestoda: Lecanicephalidae) as a biological marker for banana prawns, *Penaeus merguensis* (de Man), in the Gulf of Carpentaria. *Aust. J. Mar. Freshw. Res.*, 36:291-299.
 138. Owens, L. and J.S. Glazebrook, 1985. The biology of bopyrid isopods parasitic on commercial penaeid prawns in northern Australia. In P.C. Rothlisberg, B.J. Hill and D.J. Staples, (eds.), *Second Aust. Nat. Prawn Sem. NPS2*, Cleveland, Australia, 105-113.
 139. Owens, L., 1983. Bopyrid parasite *Epipenaeon ingens* (Nobili) as a biological marker for banana prawns *Penaeus merguensis* (de Man). *Aust. J. Mar. Freshw. Res.*, 34:477-481.
 140. Paynter, J.L., D.V. Lightner and R.J.G. Lester, 1985. Prawn virus from juvenile *Penaeus esculentus* pp. 61-64 In: P.C. Rothlisberg, B.J. Hill and D.J. Staples (eds.), *Second Australian National Prawn Seminar NPS2* Cleveland, Australia.
 141. Rosenberry, B., 1989, 1990. World Shrimp Farming 1988 and 1989. Both supplements to *Aquaculture Digest*. 9434 Kearny Mesa Rd., San Diego, CA 92126. Dated Jan. 1989 and Jan. 1990 respectively.
 142. Sano, K. 1979. *Aquaculture and water*. Scientist Inc. Tokyo.
 143. Sano, T. and H. Fukuda, 1987. Principal microbial diseases of mariculture in Japan. *Aquaculture*, 67:59-69.
 144. Sano, T., T. Nishimura, H. Fukuda, T. Hayashida, and K. Momoyama, 1985. Baculoviral infectivity trails on Kuruma shrimp larvae of different ages. p. 397-403. In: *Fish and Shellfish Pathology*, Academic Press, N.Y.
 145. Sano, T., T. Nishimura, H. Fukuda, T. Hayashida and K. Momoyama, 1984. Baculoviral midgut-gland necrosis (BMN) of Kuruma shrimp (*Penaeus japonicus*) larvae in Japanese intensive-culture systems. *Helgolander Meeresunters*, 37:255-264.
 146. Sano, T., T. Nishimura, K. Oguma, K. Monoyama and N. Takeno, 1981. Baculoviral infection of Kuruma shrimp, *Penaeus japonicus* in Japan. *Fish Pathol.*, 15:185-191.
 147. Sawyer, T.K. and S.A. MacLean, 1978. Some protozoan diseases of decapod crustaceans. *Marine Fisheries Review Paper*, 1342:32-35.
 148. Shaughnessy, M. 1983. EDTA removes formation damage at Prudhoe Bay. *J. Petr. Tech.* pp. 1783 - 1791.
 149. Sillen, L., and A.E. Martell, 1971. Supplement No. 1 to stability constants of metal-ion complexes. *Special Publication No. 25*. The Chemical Society, London.
 150. Simpson, H.J., H.W. Ducklow, B. Deck and H.L. Cook, 1983. Brackish-water aquaculture in pyrite-bearing tropical soils. *Aquaculture*, 34:333-350.
 151. Sindermann, C.J., 1988. Disease problems caused by introduced species. pp. 394-398, In: C.J. Sindermann and D.V. Lightner (eds.), *Disease diagnosis and control in North American marine aqua*. Elsevier, Amsterdam.
 152. Sindermann, C.J. and D.V. Lightner (eds.), 1988. *Disease diagnosis and control in North American marine aquaculture*. Elsevier, Amsterdam. 431 p.
 153. Soderhall, K., L. Hall, T. Unestam and L. Nyhlen, 1979. Attachment of phenoloxidase to fungal cell walls in arthropod immunity. *J. Invet. Pathol.*, 34:285-294.
 154. Solangi, M.A. and D.V. Lightner, 1976. Cellular inflammatory response of *Penaeus aztecus* and *P. setiferus* to the pathogenic fungus, *Fusarium* sp. isolated from the California brown shrimp *P. californiensis*. *Journal of Invertebrate Pathology*. 27(1). 77-86.
 155. Sparks, A.K., 1985. *Synopsis of Invertebrate Pathology Exclusive of Insects*. Elsevier, Amsterdam. pp. 423.
 156. Sparks, A.K., 1981. Bacterial diseases of invertebrates other than insects, In: *Pathogenesis of invertebrate microbial diseases*, Davidson E.W. (ed.) Allanheld, Osmum, Totowa, New Jersey, 323.
 157. Sparks, A.K., 1980. Multiple granulomas in the mid-

- gut of the dungeness crab, *Cancer magister*. *J. of Invertebrate Pathol.*, 35:323-324.
158. Spotts, D.G. and P.L. Lutz, 1981. L-lactic acid accumulation during activity stress in *Macrobrachium rosenbergii* and *Penaeus duorarum*. *J. World Mar. Soc.*, 12:244-249.
159. Stern, S. and D. Cohen, 1982. Oxygen consumption and ammonia excretion during the molt cycle of the freshwater prawn, *Macrobrachium rosenbergii* (de Man). *Comp. Biochem. Physiol. A.*, 73:417-419.
160. Sunda, W. and R.L. Guillard, 1976. The relationship between cupric ion activity and the toxicity of copper to phytoplankton. *J. Mar. Res.* 34: 511 - 529.
161. Tsing, A. and J.R. Bonami, 1987. A new viral disease of the tiger shrimp *Penaeus japonicus* (Bate). *J. Fish Diseases*, 10:139-141.
162. Tsing, A., D.V. Lightner, J.R. Bonami and R.M. Redman, 1985. Is gut and nerve syndrome (GNS) in the tiger shrimp *Penaeus japonicus* (Bate) of viral origin? 2nd International Conf. of the European Association of Fish Pathologists, Montpellier, France (abstract).
163. Vogt, G., 1987. Monitoring of environmental pollutants such as pesticides in prawn aquaculture by histological diagnosis. *Aquaculture*, 67:157-164
164. Vogt, G., V. Storch, E.T. Qunitio and F.P. Pascual, 1985. Midgut-gland as monitor organ for the nutritional value of diets in *Penaeus monodon* (Decapoda). *Aquaculture*, 48:1-12.
165. Wheaton, F.W., 1987. **Aquaculture Engineering.** Robert E. Krieger Publishing Co. Malabar, Fla. 708 pages. Original Copyright 1977 by John Wiley & Sons, Inc.
166. Wickins, J.F., 1984. The effect of hypercapnic seawater on growth and mineralization in penaeid prawns. *Aquaculture*, 41:37-48.
167. Wiseman, M.O., R.L. Price, D.V. Lightner and R.R. Williams, 1982. Toxicity of aflatoxin B₁ to penaeid shrimp. *Appl. Microbiol.*, 44:1479-1481.
168. Wu, Y. and M. Lu, in press. Electron microscopic studies on *Vibrio* red leg disease of penaeid shrimp. *Proc. Fifth Cong. Chinese Soc. Oceanol. Limnol.*
169. Yasuda, K. and T. Kitao, 1980. Bacterial flora in the digestive tract of prawns, *Penaeus japonicus* (Bate). *Aquaculture*, 19:229.
170. Yuan, Y.X., C.N. Gao and D.X. Zhang. 1992. Metamorphosis to postlarvae of *Penaeus chinensis* Osbeck by removal of heavy metals from rearing systems with polymeric absorbent. *J. World Aquaculture Soc.*, 23: 205-210.
171. Zheng, G., 1988. The success of the separate infection of pathogenic bacteria of the "Red Leg" disease of Dui Xia. *Marine Fisheries*, 1:34 (in Chinese).
172. Zamuda, C.D., and W.G. Sunda, 1982. Bioavailability of dissolved copper to the american oyster *Crassostrea virginica* I. Importance of chemical speciation. *Mar. Biol.* 66: 77 - 82.

Chapter 7

Drugs Used in Shrimp Hatcheries as Chemotherapeutants

Necessity of Antibiotics (Chamberlain, 1988)

One of the hottest discussion topics among hatchery biologists is disease control and antibiotic usage. Despite use of disinfectants and diligent management, disease commonly occurs in shrimp-larval rearing tanks where large numbers of larvae are closely confined in a nutrient-rich medium.

If recognized early, some disease problems can be controlled by reducing stress due to poor water quality, inadequate nutrition, or poor handling. However, even with good management, minor problems can sometimes develop into major proportions and cause severe economic losses if appropriate drugs and chemicals are not used. The question, of course, is "which treatments and dosages are appropriate?"

Problems with Antibiotics (Chamberlain, 1988)

Health Hazards to the User

Certain antibiotics, such as chloramphenicol, are highly toxic and are potentially harmful even to people who come into incidental physical contact with them. Although chloramphenicol is widely used in international hatcheries, the U.S. Food and Drug Administration has indicated that "This drug may not be used for any purpose in the U.S. aquaculture and exotic fish industries."

Bacterial Resistance

Prolonged exposure of a bacterial population to a given antibiotic can result in development of pathogens that are resistant to that antibiotic. This resistance can occur either by mutation within the target bacterial population or by inadvertent selection of a minor percentage of the original population that was innately resistant.

Certain antibiotics, such as oxytetracycline and chloramphenicol, are particularly prone to resistance by mutation because of the enzymatic pathway they are designed to block. Other antibiotics, such as Romet-30, target pathways where resistance through mutation is less likely.

Hazardous Residues

Some compounds may leave residues that pose potential health hazards to consumers of the product. This is usually not a consideration with larval shrimp, but might be important if antibiotics are used to treat market-sized shrimp. (Castile and Lawrence, 1986. "The Toxicity of Erythromycin, Miocycline, Malachite green, and Formalin to Nauplii of *P. stylirostris*, World Aquaculture Society 17(1):13-18.

Overuse of Antibiotics

The typical scenario for antibiotic usage in Ecuador is

to use continuous low dosages in the culture water beginning at the protozoal substage. As bacterial resistance occurs, the dosage is increased until it becomes necessary to rotate to another antibiotic. Some of the commonly-used antibiotics are furazolidone, nitrofurazone, nifurpirinal, erythromycin and chloramphenicol.

Eventually, bacteria within the hatchery becomes resistant to each of these antibiotics as well as to combinations. At that point, production is stopped, the hatchery is dried out and completely disinfected (including water lines) using a combination of chlorine and lime (to elevate pH). Not only must this costly dry-out procedure be followed routinely, it is suspected that antibiotic-resistant bacteria (from hatchery effluent) may be becoming established in the wild flora and re-entering the hatchery with clean seawater.

Bacterial resistance to antibiotics may eventually result in discontinuing prophylactic-treatment methods. One method of improving drug effectiveness is to administer antibiotics to larvae internally through the diet rather than externally through the culture water. This approach should be possible through the use of artificial larval diets.

The June 1989 issue of World Aquaculture published an article by Janet Brown entitled "Antibiotics: Their Use and Abuse in Aquaculture." This article is noteworthy because it states that the prophylactic use of antibiotics is hastening the evolution of antibiotic-resistant strains of bacteria which is creating significant problems in aquaculture and may increase the risk to human health.

General Use of Antibiotics

The following is a list of commonly-used drugs in hatcheries outside the United States and their prescribed dosages (provided by Mike Yates of Aquatic Farms, Ltd-INDIA):

Common Drugs Used in World Hatcheries as Chemotherapeutants and Applicable Dosages

Chloramphenicol

- Possible hazard to humans - banned in United States (and possibly India).
- Used as prophylaxis in spawning tanks or to combat "dirt" and necrosis (1-4 ppm).
- Used in larval tanks as prophylaxis for three successive days (4 ppm) after each major molt.

Prefuran

- Used as prophylaxis generally [0.05 to 0.1 ppm (10 percent active)].
- Used at any stage when larvae appear sick (lethargic, necrosis, etc.).

Furazolidone

- Used to clean up "slime" or routinely for three days from PL1 (1ppm).

Treflan

- Used routinely for three days after stocking larvae (0.05 ppm).
- Used if *Lagenidium* is evident on dead animals (0.05 ppm).

Malachite Green

- "May" help to control gregarines - daily between second day of Z1 and PL3 (0.0075 ppm).

Oxytetracycline (4 ppm) & Erythromycin (2 ppm)

- Used if all other drugs fail - not well thought of. Erythromycin "might" cause deformities of setae.

NOTE:

- None of the above drugs are administered during Z3/ M1 transition because larvae are prone to deformities and mortality.
- When starting-up a hatchery, "routine" prophylaxis should be used sparingly at first. When no longer effective they should be switched to another in the hopes of prolonging durations between forced shut-downs, etc.
- Many of these drugs listed above have not been approved for use in the United States (see explanation in the following section, "Chemotherapeutants in United States Shrimp Hatcheries").

Diligent management procedures have been developed through the years. Examples of these routines can be seen in the following tables and figures:

Table 9. Routine Prophylactic Treatments for Shrimp Larvae (Method used by Clyde Simon, 1989).

Table 10. Alternate Method of Larval Culture Se-

Table 9. Routine Prophylactic Treatments for Shrimp Larvae. (Method used by Clyde Simon of Aquatic Farms Ltd.). 1989

Larvae: Treflan: Days 1, 2 and 3 - 0.05 ppm each day

Stage	Treatment	
N ₆	1.0 ppm	Prefuran
Z ₂	4.0 ppm	Oxytetracycline
M ₁	4.0 ppm	Chloramphenicol
M ₂	1.0 ppm	Prefuran
PL ₁	4.0 ppm	Erythromycin
PL ₂	2.0 ppm	Erythromycin
PL ₃	2.0 ppm	Erythromycin
	(after transfer to PL section)	
PL ₆	4.0 ppm	Oxytetracycline
PL ₉	1.0 ppm	Prefuran
PL ₁₂	4.0 ppm	Erythromycin
PL ₁₅	1.0 ppm	Prefuran
PL ₁₇	4.0 ppm	Chloramphenicol

quences, Postlarval Feeding Regime and Disease Preventative Schedule used by Josh Wilkenfeld, 1989.

Figure 52. Chemical and Antibiotic Treatments used in Philippine Hatcheries.

Figure 53. Forms Used for the Calculation of Drug and chemical Requirements for each tank, morning and evening.

Chemotherapeutants in United States Shrimp Hatcheries

"Potential investors in penaeid-shrimp culture in the United States face a dilemma. Expertise, materials and proximity to a large domestic market favor investment in

Figure 52. Chemical and Antibiotic Treatments Used in Philippine Hatcheries

The following is a list of chemical and antibiotic treatments that may be helpful in treating larvae where disease has been observed:

Agent	Dosage	Egg and Larval Bacteria	Treatment Larval Parasites	PL Bacteria	PL Parasites
Prefuran	0.7ppm	+++	+	+	
Arythromycin	4ppm	++	+	++	
Malachite Green	0.007ppm		?	++	+++
Treflan	0.05ppm	?	++	++	++
Furazolidone	0.5ppm	+		+	
Streptomycin	4ppm	+		+	
Tetracycline	4ppm	+		+	
Chloromphenicol	3ppm	+		+	
Neomycin	4ppm	+		+	
Formaline	2-5ppm	?	+	?	+

EDTA at 10ppm may help hatching of eggs and help purify (water) water stocking nauplii.

- +++ - 1st choice or most effective
- ++ - 2nd choice
- + - 3rd choice
- ? - uncertain as an effective treatment

Table 10. Alternate Method of Larval Culture Sequences, Postlarval Feeding Regime and Disease Preventive Schedule Used by Josh Wilkenfeld, Aquatic Farms, Ltd., 1989.

Treatment	Day	Stage	Water Management		Mesh	Alg (No/ml) (^{10AM} _{5PM})	Artemia (live) (flakes)	Frippak
			Level (T)	Drain to (T)				
CP, TFL	1	N ₅ /N ₆	6			50,000- 100,000		
CP, TFL	2	Z ₁	6			100,000		
CP	3	Z ₁	8			100,000		CAR 0.5g/T
	4	Z ₂	10			"		"
	5	Z ₃	10	7	Small	"		CAR 0.5g/T
	6	Z ₃	10	5	"	"		"
CP	7	M ₁	10	2	Big	"	0.25/ml	CD 90 0.5g/T
"	8	M ₁	10	2	"	"	"	"
"	9	M ₂	10	2	"	"	"	CD 90 1.0g/T
	10	M ₃	10	1.5	"	"	"	"
	11	M ₃	10	"	"	"	"	"
Fz	12	PL ₁	10	"	"	80,000	0.5/ml	5 g/T
Fz/Form	13	PL ₂	10	"	"	60,000	0.5/ml	"
Fz	14	PL ₃	10	"	"	50,000	1.0/ml	10 g/T
Form	15	PL ₄	10	"	"	"	1.5/ml	15 g/T
	16	PL ₅	10	"	"	"	1.5/ml	"

CP=Chloramphenicol:	TFL=Treflan (Trifluralin):	FORM=Formalin:	Malachite Green: 0.0075 ppm
1.0 ppm (1g/T) (imported)	1ml/Ton (of stock solution)	20.0 ppm (20ml/T)	Stock solution 5.625g/750ml
4.0 ppm (4g/T) (Indian)	Stock solution 10ml/190ml	Prefuran:	Use: 1ml Stock/Ton
FZ=Furazolidone:		0.5 - 1.0g/T	
1.0 ppm (1g/T)		(i.e. 0.05 - 0.1 ppm)	

Figure 53. Forms Used for the Calculation of Drug and Chemical Requirements for Each Tank, Morning and Evening.

Drug and chemical requirements: Morning Date: _____ Time: _____									Drug and chemical requirements: Evening Date: _____ Time: _____								
TANK NO.	VOL (MT)	CP (GM)	FZ (GM)	PREF (GM)	OXY (GM)	MG* (SOL)	TREF** (SOL)	FORM*** (ML)	TANK NO.	VOL (MT)	CP (GM)	FZ (GM)	PREF (GM)	OXY (GM)	MG* (SOL)	TREF** (SOL)	FORM*** (ML)
1									1								
2									2								
3									3								
4									4								
5									5								
6									6								
7									7								
8									8								
9									9								
10									10								
11									11								
12									12								
13									13								
14									14								
15									15								
16									16								
TOTALS									TOTALS								
TOTALS									TOTALS								
GM OR ML CHEM ML WATER									GM OR ML CHEM ML WATER								

To dispense: When total GM or ML of compound is known, mix with water at rate of 50 ML per unit of compound. Then dispense at rate of 50 ML of solution per GM or ML of chemical required for any given tank.

Definitions and normal dosages:

CP = Chloramphenicol; 4ppm = 4 GM/MT

FZ = Furazolidone; 1 ppm = 1 GM/MT

PREF = Prefuran; 0.05-0.10 ppm = 0.5-1.0 GM/MT (10% active)

OXY = Oxytetracycline; 5 ppm = 5 GM/MT

MG* = Malachite green; 0.0075 ppm = 1 ML/MT of solution made from 5.625 GM malachite green in 750 ML water

TREF** = Treflan; 0.05 ppm = 1 ML/MT of solution made from 10 ML Treflan in 200 ML water

FORM*** = Formalin; 50 ppm for one hour = 50 ML/MT

the developing United States shrimp-culture industry, while climatic factors, operating costs and regulatory constraints oppose it. To compete, a United States producer must be more cost effective and have a more intensive-culture system. The use of chemotherapeutants may be required to maintain cost effectiveness in an intensive culture to reduce the disease problems. The classes of needed agents range from the antibiotics and antifungals to disinfectants and water-quality agents. These chemotherapeutants must be both reasonably priced and readily available. In the United States, availability and to some extent cost, is dependent on clearance by the United States Environmental Protection Agency (EPA) and the United States Food and Drug Administration (FDA). The EPA is responsible, for the most part, for those pesticides, disinfectants, algicides and water sanitizers with no claim for disease control, while the FDA regulates substances used as therapeutants and food additives."

"Only Aquatrine (also known as Cutrine-Plus) has been approved for use in penaeid-shrimp culture in the United States. Several other compounds used by shrimp culturists are on the FDA Generally Recognized As Safe (GRAS) list. These are: sodium bicarbonate, acetic acid, calcium oxide (lime) and calcium hypochlorite [chlorinated lime]. Most other compounds are being used without approval, and thus illegally. Several compounds are well into the approval process. These are formalin, oxytetracycline and trifluralin."

"Formalin is used in controlling peritrichous ciliate gill and surface fouling organisms of the genera *Zoothamnium*, *Epistylis* and *Vorticella*, as well as other fouling organisms such as algae and filamentous bacteria. An Investigational New Animal Drug (INAD) permit was issued to the University of Arizona in 1983 for formalin use in penaeid-shrimp culture. The University of Arizona has worked in cooperation with the United States Fish and Wildlife Service and with the sponsor (Natchez Animal Supply Co., Natchez, MS, and with another sponsor if Natchez elects not to pursue approval of formalin). Since then, the studies specified by the FDA have been completed. The FDA has reviewed the data from these studies and accepted them as supporting approval for this use. Only revision of the Master File, Freedom of Information Summary and writing the draft label remains for completion of the approval process. Thus, it is estimated that the approval process for formalin is about 95 percent complete."

Oxytetracycline

"Oxytetracycline is used to treat bacterial disease in shrimp grow-out facilities. This drug, because of its reaction with the calcium in seawater, is most effective if given in feed and is not efficient as a water-borne treatment. Oxytetracycline has been approved by FDA as a feed additive for use in lobster-holding facilities to control gaffkemia and in Japan in medicated feeds for treating vibriosis in penaeid shrimp. It is effective against a large percentage of the bacteria, primarily *Vibrio* species, isolated from diseased penaeids. In 1984, the FDA issued an INAD permit to Pfizer, Inc., that allowed cooperative work with Marine Culture Enterprises and the University of Arizona for the approval of the use of oxytetracycline in

penaeid shrimp. Work on approval of oxytetracycline is approximately 50 percent complete. In 1986, FDA, Pfizer, Inc., and the University of Arizona reviewed the data generated under the INAD. Five studies were identified as yet to be completed. They included (1) a feed storage stability study, (2) a field trial to complete efficacy data, (3) an additional residue-depletion study to reduce the withdrawal time from seven to three or four days, (4) a residue depletion study in broodstock, and (5) a study to determine the presence of the drug in tank or pond effluent water under field conditions."

Trifluralin (Treflan)

"Trifluralin is an herbicide that is effective in the prevention of larval mycosis. It is applied as a water treatment to inhibit the growth of the phycomycetous fungi *Lagenidium* sp. and *Sirolopidium* sp. in the seawater of hatching facilities. This compound appears to be a good substitute for malachite green for this particular use. The registration process for trifluralin is in its early phases. A sponsor for trifluralin has not been identified, and without a sponsor, registration is not possible. Although IR-4 may sponsor a compound for approval or registration, the manufacturer of the compound must permit the use of data in its Master File and either the manufacturer or a company with distribution rights must be willing to add the new usage to its label. Discussions with FDA indicate that EPA will be responsible for regulating this compound. Several efficacy studies are in the literature as well as a study documenting relatively low toxicity to penaeid larvae compared to its effective dose. A residue study and a study on trifluralin dynamics under hatchery conditions has been completed. This data indicated no detectable tissue residues in small juvenile shrimp that had been exposed to trifluralin as larvae and confirmed the report from Aquacop (1977) that trifluralin is rapidly lost from hatchery water. Possibly 50 percent of the required studies for registration have been completed. A copy of a draft master file was submitted to IR-4 for review in 1984 and 1988."

One study indicated that treflan (trifluralin), which is commonly used in hatcheries to treat fungal diseases due to *Lagenidium* and *Sirolopidium*, is rapidly lost by aeration, photodegradation, and absorption by unicellular algae. This substantiates the information presented by LeBitoux and the Aquacop team in 1977. They recommended that Treflan be administered drop by drop for 12 hours a day.

According to a more recent study, the estimated half-life, under varying conditions of aeration and light, ranged from 30 to 138 minutes. When diatoms were added to the seawater, Treflan levels dropped to 4 percent of theoretical levels within two to three minutes. These results confirm the need for continuous administration of Treflan to maintain an effective dosage for treatment of larval mycoses. (Source: Williams, R.R., T.A. Bell, and D.V. Lightner., 1986. Degradation of trifluralin in seawater when used to control larval mycosis in penaeid shrimp culture. *Journal of the World Aquaculture Society* 17:8-12).

Compounds to be Replaced

"Several chemotherapeutants in common use in the penaeid culture industry have a very poor chance of approval either by FDA or EPA. The first of these is

malachite green. Malachite green is an extremely useful compound in treating and preventing larval mycosis of the variety noted above as well as treating gill fouling of peritrichous ciliates, algae and filamentous bacteria. However, it has been shown to be a potential teratogen and carcinogen in laboratory animals."

"The nitrofurans class of antibacterials used in shrimp culture include nitrofurazone (Furacin), furazolidone and nifurpirinol (Furance). Nitrofurazone and furazolidone have been used to treat external bacterial and fungal infections in fish and shrimp. Both nitrofurazone and furazolidone have been implicated as potential carcinogens. Nifurpirinol is absorbed from the water and is effective against a wide range of bacteria that cause problems in both fish and shrimp, as well as *Saprolegnia* sp. infections in fish. Nifurpirinol was registered for use on aquarium fish, but is no longer available."

"Chloramphenicol (Chloromycetin) has been used primarily to control bacterial disease (primarily vibriosis) in hatchery operations because of its activity against this group of gram negative bacteria. However, this drug may produce blood dyscrasias such as aplastic anemia in humans. In an official statement, FDA noted that the 'drug is potentially harmful even to people who come into incidental contact with it. This drug may not be used for any purpose in the aquaculture and exotic fish industries.' Therefore, approval of chloramphenicol is not likely."

Needed Chemotherapeutants

"Bacterial disease syndromes are a significant problem in penaeid shrimp culture, affecting primarily larval, postlarval and juvenile stages. Replacements for chloramphenicol and the nitrofurans are needed, particularly in the hatchery phase. Primary candidates for replacing chloramphenicol include oxolinic acid, nalidixic acid, or other 4-quinolone antibiotics; the various potentiated sulfonamides of which Romet-30 (sulfadimethoxine + ormetoprin) and Septra (sulfisoxazole + trimethoprim) are examples, and the tetracyclines (tetracycline, oxytetracycline and chlortetracycline). Other less likely antibiotics needing further investigation are the aminoglycosides (streptomycin, kanamycin, neomycin and gentamycin), erythromycin, lincomycin and some non-potentiated sulfonamides such as Dimeton (sulfamonomethoxine). Formalin has been used as a disinfectant and water pretreatment chemical to reduce bacterial loading of larval rearing tank water. For use with larval stages prior to the mysis stage, an ideal antibacterial drug or chemotherapeutant would need to be soluble in water and not appreciably toxic to the species of algae fed to the larvae. Once the larvae are at the stage where zooplankton is given as food, water-insoluble antibiotics may be provided by orally incorporating the drug into *Artemia* nauplii or other organisms prior to their being fed to the larvae."

The May 1989 issue of Fish Farming International reports that formalin, oxytetracycline and trifluralin are nearing approval by the U.S. FDA and EPA, but malachite green is expected to be turned down.

Acknowledgements and References

Many thanks to Mike Yates, Josh Wilkenfeld, Clyde Simon and Andy Kuljis for a portion of the information given in Chapter 7. It is very generous and commendable of these gentlemen to share information of this nature with others. Also, the section on United States shrimp hatcheries and the use of chemotherapeutants was taken from "Regulatory Status of Therapeutants for Penaeid Shrimp Culture in the United States" Rodney Williams and Donald Lightner, (Vol. 19, No. 4, *Jrnl. of World Aquaculture Society* (Dec. 1988) and a portion of the March 1989 issue of *Aquaculture Digest*, and some of the antibiotic comments were cited from *Coastal Aquaculture*, Chamberlain, 1988.

Chapter 8

Results of Larval Rearing and Postlarval Rearing Trial Runs at Yayasan Dian Desa Hatchery

Larval and postlarval trial runs were made during July and August 1987 at the Yayasan Dian Desa Hatchery in Jepara, Indonesia.

The intensive-culture system was used with both larvae and postlarvae with very good results. The results of the trial runs are as follows.

One spawn from a *Penaeus monodon*, wild-caught ablated female produced 720,000 nauplii. This spawn was the second spawn from the female after ablation. This spawn was split into two equal parts (360,000 nauplii each) and placed in two conical larval-rearing tanks with a 4,000 liter capacity. Only 1,000 liters of water was used to start. Each day new seawater was added (filtered to one micron, 28 ppt salinity) and then feed was added according to the schedule on Table 1. Water volumes of the tank kept on a daily basis can also be found on this table. A daily record was kept and temperatures, feeding practices, disease treatments etc. were all recorded on a larval rearing data log. Data logs for LRT 1 and LRT 2 are in Tables 11 and 12.

Results of Larval Rearing Runs:

Tank No	Dates of Run	Survival Percentage			
		PL1	PL2	PL3	PL4
1	July 22-Aug. 3	82	61.5	—	59
2	July 22-Aug. 4	73	53	—	48.5

Numerical population estimates were as follows:

Tank #	Number of Shrimp Surviving			
	PL1	PL2	PL3	PL4
1	296,400	221,666	—	212,940
2	264,100	191,000	—	174,800

Note that LRT 1 was one stage ahead of LRT 2. This was directly related to temperature; LRT 1 had two heaters and LRT 2 had one heater. Also, survival was lower in LRT 2 and is thought to have a direct relationship with disease treatments. Only when disease was obvious and mortalities appeared was disease treatment administered. This approach had an obvious bearing on the survival as no treatment was given in tank 2 until the Mysis III substage, even though some mortality was noted as early as the Z3-M1 substages. Mortalities always appear in these stages even under optimum conditions. It is also common to see mortalities at the N to Z transition and the Z3 to M1 stage transition.

The appearance of *Zoothamnium* in tank 1 at PL4 complicated the transfer. The problem was first treated with 0.1 ppm of malachite green (m.g.) with no success. The next day 1 ppm m.g. was used to get rid of the problem. With the combined problems of treating and transferring at the same time, the survival rate declined (61.5 percent at

PL2 to 59 percent at PL4). This is still an above-average survival rate for *P. monodon* which usually runs around 48 percent in the hatchery (according to Aquacop, 1983). *Artemia* became a problem as soon as the PL4s went into the 13-ton holding and rearing circular raceway. *Artemia* instars were settling out or were dead when introduced to the tank as food. The problem was traced back to the decapsulation process, when it was found that the wrong amount of chemicals were being used. Once this problem was solved, the *Artemia* became a good food source.

Temperature in the raceways was continuously low (25.1 degrees C to 27 degrees C); therefore, growth was very slow. *Lagenidium* sp. was a constant problem in Raceway 7 (with 212,940 PLs) and occasionally bacterial necrosis developed in Raceway 8 (with 174,800 PLs). Treflan 5-ppm solution was administered for the *Lagenidium* at a dose of 50 ml/ton or 635 ml for Raceway 7 and chloramphenicol was given for the bacteria in 2-ppm to 10-ppm doses, depending on the severity of the bacterial attack. There was an estimated 95 percent or greater survival in Raceway 7 (stocked with 212,940 PL4s) and an estimated 80 to 85 percent survival in Raceway 8 (stocked originally with 174,800). Mortality in Raceway 8 came when the habitat screens were not placed below the water surface and the water flow and airlift bubbles left many PLs high and dry on the screen (a hard lesson learned). Table 13 shows the actual tank log for Raceway 7.

Raceway 8 was first held at 7,000 liters instead of 12.65 tons, as in Raceway 7, in an attempt to save *Artemia* (feeding a smaller volume tank). This proved to be a mistake because of temperature and water circulation problems, so the volume in Raceway 8 was brought up to the same level as Raceway 7. Table 14 gives the actual tank log for Raceway 8.

In addition to *Artemia*, a pellet diet was given to the PLs starting at PL6. The feeding rate is outlined on Table 1. Weights of the animals were very difficult to obtain accurately with the equipment at the laboratory. Previous feeding studies at Dian Desa in 1990 showed that a PL2 weighed 0.000238 grams. Previous experience by Mr. Bagiyo indicated that a PL1 should weigh 0.085 grams. Therefore, attempts were made to obtain those PL weights of the shrimp in Raceways 7 and 8. One attempt showed that 27 PL8s weighed 0.01 grams or about 0.0003 grams each. Another attempt with the same scale indicated that the average weight of 38 PL8s was 0.005 grams each. Therefore, an average weight of 0.3 to 5 mg each should be within an acceptable range. Previously feed amounts were calculated using the weight from Mr. Bagiyo (0.085 g) x number of PLs in tank x 200 percent body weight per day. This 200 percent feed (President's # New 1) was split into

Table 11. Actual Larval Rearing Tank Log for Tank Number 1.

Tank # 1 Date Stocked 7/22 #Nauplii Stocked 360,000 #PL's 216,125 %Sur. 8%

(Page 1 of 2)

Date	Time	Stage	Health	Temp.	Algae		Artemia		Comment
					Species	Cells/ml	Amt.	#/ml./	
7/22	1030	N ₂	SAMPLE 10 1 DEAD 9 HEALTHY	27.8	—	—	—	—	—
7/22	1420	N ₃ -N ₄		28.0	—	—	—	—	pH 8.03
7/22	1800			27.2	Chaet.	0	50k/ml	—	3 CARBOYS
7/23	0700	STILL N		26.3	Chaet.	75,000/ml	0	—	TOO COLD!!
7/23	0930			26.9					
7/23	1200	N ₆	SOME DEBRIS	27.0					1 PPM EDTA
7/23	1500	Z ₁	OK	27.2	"	85,000/ml	2 BOTTLES	—	
7/23	2130			27.5					pH 8.18
7/24	0645	Z ₁	OK	26.9	"	50k/ml	2 BOTTLES	—	ADD SEAWATER
7/24	1200			27.3					INSTALL HEAT
7/24	1800			28.0	"	120/000	0		1g EDTA, 1g Chloro.
7/25	0700	Z ₂	OK	27.8	"	40/000	69/000	—	2 BOTTLES
7/25	1100			28.0	"	60,000	40/000	—	2 BOTTLES
7/25	1600			28.5	"		2 BOTTLES	—	pH 8.06
7/26	0700	Z ₂ -Z ₃	OK	28.2	"	40,000	60,000	—	3g EDTA 3g Chloro.
7/26	1200	Z ₂ -Z ₃	POP. EST. 300,000	29.0	Chaet./Tetra.	80k/Chaet	20k/Tetra.	—	
7/26	1900	Z ₃	OK	28.0	"			—	
7/27	0700	Z ₃	Healthy	28.0	Chaet./Tetra.	50k Cha./25k Tet.		—	
7/27	1200	Z ₃		29.0	"			—	pH 8.07
7/27	1800	Z ₃ -M ₁	SOME MORTALITY	29.0	"			0	~600ml Art.
7/28	0700	M ₁		28.0	"		Chaet. 1B TET. 3B	25/100ml	95/100ml
7/28	0945	M ₁		28.2	"				1/3 water exchange
7/28	1630	M ₁ -M ₂		28.5	"		1 BOTTLE TETRA		
7/28	2100	M ₂		29.0	"				
7/29	0700	M ₃		29.0	"				1/3 water exchange
7/29	0930	M ₃		28.0	"	15,000/ml	Chaet. 1B TET. 2B	6/ml	
7/29	1200			29.0	"				
7/29	1800			29.0	"				
7/30	0100	M ₃		28.5	"	near 0	CHAE. 1B TET. 2B		FLOR. PSEUDO.* NOTED
7/30	0700	M ₃	2 EMPTY GUTS 1 FULL GUT	28.2	Tetra. only	near 0	TET. 1B		
7/30	1200			28.9	Tetra.	5,000	20,000 5 BOTTLES	2/ml	4/ml
7/30	2015	M ₃	PSEUDOS ACETAB. NO FOOD IN GUT	28.5	"				pH 8.1
7/31	0700	PL1		29.0	"				200ml TREFLAN POP. EST. = 78/l
7/31	1200			29.0	Tetra.	10,000	10,000 (2 BOTTLES)	1/ml	5/ml
7/31	2300	PL1	**						(78/l x 5000) = 390,000 = 62%

COMMENTS: * on 7/30 at 0100HRS. FLOURESCENT pseudomonas noted ∴ 1/3 water exchange initiated and 4grams of Chloro. added.
 ** Treat 5ppm chloro. and 190ml Treflan

Table 11 (continued).

Tank # 1 Date Stocked 7/22 #Nauplii Stocked 360,000 #PL's 276,400 %Sur. 82

(Page 2 of 2)

Algae									
Date	Time	Stage	Health	Temp.	Species	Cells/ml	Amt. intank	Artemia #/ml./ #fed	Comment
8/1	0730	PL2		29.0	Tetra.		2 Bottles	.1.9 4.2/ml	TURN HEAT DOWN
8/1	1200	PL2	GOOD	29.0	"				POP. EST. *
8/1	1600	PL2	OK		"				1/4 water exch.
8/1	2300		PSEUDO NOTED	28.5	"				TREAT **
8/2	0730	PL3		27.5	Tetra.		2 Bottles		
8/2	1200	PL3		28.5	"			1 5	1/2 water exch.
8/2	1600	PL3			"		1 Bottle		
8/2	2130	PL3		28.5					TREAT ***
8/3	0700	PL4		28.0					pH 8.1
8/3	1030	PL4		27.8				1 5	POP. EST. ****
8/3	1100		READY TO HARVEST						START INFLOW TO ACCLIMATE
8/3	1130		Zoothamnium	28.1					FLUSH
8/3	1400			28.1					BEGIN TRANSFER
8/3	1810								TRANSFER COMPLETE TO RACEWAY #7

COMMENTS: * Pop. est. on 8/1 $91/L = 345,800$ $37/L = 140,600$ $\bar{x} = 91 + 37 = 64/L = 243,200$ PL2
 $47/L, 91/L + 37/L \bar{x} = 58.3/L \times 3800L = 221,666$ PL2 = 61.5%

** TREAT. 3ppm Chloro. and 100ml Troflan

*** TREAT 3ppm Chloro. and 2ppm EDTA

*** pop. est. = $61/L, 49/L, 56/L, 95/L, \bar{x} = 65.25/L \times \text{vol.} = 3600 = 226,800$ (estimate).

$54/L, 61/L, 49/L, 56/L, 95/L, \bar{x} = 63/L \times \text{correct volume } 3380L = 212,940$ PL4

Zooth. noted. Also bad Artemia in new raceway (most dead) fed 6/ml, only 1/ml alive.

Table 12. Actual Larval Rearing Tank Data for Tank Number 2.

Tank # 2 Date Stocked 7/22 #Nauplii Stocked 360,000 #PL's 264,100 % Sur. .73
 (page 1 of 2)

Date	Time	Stage	Health	Temp.	Algae		Artemia		Comment
					Species	Cells/ml	Amt. fed	#/ml./ #fed	
7/22	1000			27.8					
7/22	1425	N3-N4	OK	28.0					pH 8.03
7/22	1800			27.2	Chaet.	0	50k		(3 BOTTLES)
7/23	0700	N5-N6	OK	26.3	"	72k	0		TOO COLD !!
7/23	0930			26.9	"				
7/23	1200			27.0	"				
7/23	1500	Z1	OK	27.2	"		2 BOTTLES		pH 8.14. Add water
7/23	2130	Z1	OK	27.5	"	10k	90k		
7/24	0645	Z1	OK	27.0	"				
7/24	0930	Z1	OK	27.0	"	65k	50k		pH 8.13. Add H2O
7/24	1200	"	"	27.1	"				
7/24	1800	"	"	27.2	"	120k	0		
7/25	0700	Z2	OK *	27.2	CHAET. + Tet.	30k	70k		1 BOTTLE BALN
7/25	1100			27.5	"	60k	40k		2 BOTTLES
7/25	1600			27.8	"				pH 8.08
7/26	0700	Z2-Z3	OK**	27.8	"				
7/26	1200			28.0	"				
7/26	1900	Z3	OK	28.0	"				Protozoans in
7/27	0700	Z3	Healthy	27.2	Chaet. + Tet.	50k	50k		Algae culture
7/27	1200	Z3		28.0	"	55k Chaet.			
7/27	1800	Z3	OK	28.0	"	20k Tet.		0	1/ml
7/28	0700	Z3-M1	SOME MORT - OK	28.0	Chaet. + Tet		10/3 Bot.	.25	.75/ml
7/28	1530	M1-M2	SOME MORTALITY	28.0	Tet.		1 BOTTLE		
7/29	0700	M2	Full GUTS	28.0	Tet.	10k	3 BOTTLES		
7/29	0930		***	27.5				3/ml	LEAKY STAND - pipe screen ***
7/29	1200	M2		28.0					
7/29	1800			28.1					
7/30	0100	M3	pseudo noted	28.0	Chaet. + Tet.		3B/1B		1/3 water exchange
7/30	0700	M3	? EMPTY GUTS FULL GUT	27.9					CONTENTS OF GUT GREEN.
7/30	1200			28.5	Tet.	5,000/ml	20k/ml	2	4
7/30	1500		Lug. Noted						
7/30	2030		pseudo. bad!	28.1					DRAIN 1/3 + Treat
7/31	0700		MORE pseudo.	28.3					*****
7/31	0800	M3	NO FOOD IN GUTS						
7/31	0900	M3							Pop. est. *****

COMMENTS: * HEATERS ADDED, RAISE WATER LEVEL
 ** POPULATION ESTIMATE: average 52/500ml or 342,000 Z2-Z3's
 *** Leaky stand pipe screen - noticed animals escaping through screen...
 **** 1/3 water exchange
 ***** b.g. Chloro (38) and 200ml Treflan (5ppm solution: 50ml/m³) 7/30(2030).
 7/31(0700) 16g Chloro. (4ppm), 5ppm EDTA
 ***** pop. estimate 2,00 in 3800 liters or about 7% survival to M3 (72/ml average count).

Table 12 (continued).

Tank # 2 Date Stocked 7/22 #Nauplii Stocked 360,000 #PL's 264,100 % Sur. 73
(page 2 of 2)

Date	Time	Stage	Health	Temp.	Algae		Artemia		Comment
					Species	Cells/ml	Amt. intank	Amt. fed	
7/31	1100			29.0	Tetra.	10K	20K	1/ml 5/ml	
7/31	1630	M3		28.5	"		20K		Water exchange 1/2
7/31	2300	M3-PL1	pseudo. noted	29.0	"				Treat *
8/1	0730	M3-PL1	OK	28.5	Tetra.		3 Bottles	1.9/ml	4.1/ml
8/1	1200	PL1	OK	28.5	"				water exch. 1/2
8/1	1600	PL1		28.8	"				pop. est. **
8/1	2230		pseudo.	28.5	"				3 ppm Chloro. 100 ml Treflan
8/2	0730	PL2		28.0	"				pop. est. ***
8/2	1200	PL2		28.0	"		1 BOTTLE		
8/2	1630	PL2		28.5			1 BOTTLE		
8/2	2030	PL2		28.0					
8/3	0700	PL3	neurosis	27.5	"	0	2 Bottles	2/ml	4/ml
8/3	0800		"						pH 8.1
8/3	1500	PL3	Zooth.	27.9					3 ppm Chloro. 2 ppm EDTA
8/4	0700	PL4	4 GOOD ZOOH.	27.5					Mix. Green 1.9g or 0.5 ppm 7
8/4	1000	PL4		27.9				0	6/ml
8/4	1200	PL4		27.9					Prep. To Transfer
8/4	1400	PL4	****	27.5					FLUSH... TRANSFER TO RACEWAY #8 ****

COMMENTS: * 7/31 (2300) Treat with 5ppm Chloro. and 190 ml Treflan
 ** pop. est. at PL1 = average 69.5/l or 264,100 PL1 (73% survival) - PL1
 *** pop. est. at PL2 = Average 50/l or 191,266 PL2 (53% survival) - PL2
 **** pop. est. at PL4 (Transfer) = Av. 46/l or 174,800 (48.5% survival) - PL4
 ***** RACEWAY at 1600 HRS 27.5°C, Treat 50 ml/T = 350 ml of 5ppm Treflan solution.

Table 13. Actual Postlarval Rearing Tank Log for Raceway Number 7.

Raceway# 7 Date Stocked 8/3 #PL's Stocked 212,940 %Survival

Date	Time	Health	Temp.	Art./ml	Amt.fed	Treatment	Comments
8/3	1630	Zooth.noted	27.5	0	6/ml		pH 8.1
8/3	1816	"				0.1ppm Mal.Gr.	Transfer
8/3	2300	"					*
8/4	0700	75% Zooth. 25% CLEAR	26.5			6.35ml Treflan	Lag. noted
8/4	1000	PL5 BETTER	27.0				
8/4	1630	PL5, Zoo. Better	27.0	0	6/ml	SIPHONED TANK	
8/4	1640					0.5ppm Mal.Gr.	
8/4	2300	Zoo. okay					
8/5	0700	PL6 okay	25.9	1	5/ml		TOO COLD
8/5	1030		26.1				**
8/6	0700	PL7 Lag.	25.9				***
8/6	0800	PL7 Lag.				6.35ml Treflan	***
8/6	1130	PL7 "	25.9			Algae fed	(1 BOTTLE)
8/6	1800	PL7 "	26.1				
8/7	0700	PL8 "	25.9		3/ml	PRESIDENT'S FEED 2g/DAY	1 BOTTLE ALGAE
8/7	1300	PL8 "	26.9			STATIC FLOW 6.35ml TREFLAN	
8/7	1700	PL8 "	26.1			2 PPM EDTA	
8/8	0700	PL9-DEBRIS	25.5			6.35ml Treflan	
8/8	1200	PL9 - Good	26.2				
8/8	1430	PL9 "				400ml Treflan	
8/9	0700	PL10 "	25.5			6.35ml Treflan	as Prev.
8/9	2130	PL10(NECROSIS)	26.2			3PPM CHLORO.	STATIC FLOW
8/10	0700	PL11	25.2				TOO COLD

* 8/3, 2300 HRS. STATIC FLOW, TREAT Mal.G. Green at 1ppm.

** Pellet feed started at 4.5g/DAY ÷ 4 times a day. (100% body wt./Day)

*** 1 BOTTLE CHAETO. FOR REMAINING ARTEMIA

**** 9g pellet fed ÷ 4 times/DAY (200% Body WT./DAY)
Noted many PL7's around edge of tank.

Table 14. Actual Postlarval Holding and Rearing Data for Raceway Number 8.

Raceway# 8 Date Stocked 8/5 #PL's Stocked 174,800 %Survival

Date	Time	Health	Temp.	Art./ml	Amt.fed	Treatment	Comments
8/4	0700		26.5				No animals yet
8/4	1630	GOOD *	27.5				PH 8.2, PL4
8/4	2300	OK	27.5				
8/5	0700	weak...**	25.9				PL5, Too cold
8/5	2200		27.0				PL5
8/6	0700	SOME MORT. RED NERVE...	25.1		5/ml	2 ppm EDTA	PL6, feed***
8/6	1130			BAD OR DEAD ART.			****
8/6	1800		26.1		4/ml		PL6
8/7	0700	MORTALITY NOTED	25.1				PL7 ****
8/7	1400		26.5			algae put in	INCREASE TANK LEVEL (12T) + increase Feed
8/7	1800		26.9		3/ml		
8/8	0700		25.9			12.7 T water	increase Feed
8/8	1400		26.9			algae put in	PL8
8/8	1630		27.0				
8/9	0700	Good	26.0			635ml Treflan	PL9
8/9	1200		26.1				
8/9	2200	necrosis	26.9			3ppm Chloro.	Static flow
8/10	0700		25.9				TOO COLD!

* Treat tanks as precaution 50ml/T (Tank at 7T Volume) = 350ml Treflan.

** Bacterial infection (red nerve endings noted...) 3ppm Chloro.

*** 100% Body wt. pellet.

**** BAD PROCEDURES FOUND ON Art. decapsulation - corrected (wrong amt. Na used).

***** MORTALITY CAUSED BY screen clogging during night and raising water level in tank; when screen was cleaned and water level dropped, it trapped larvae on habitat screens in the tank leaving them "high & dry".

4 feedings per 24 hours (0700, 1200, 1700 and 2200 hours). The leftover feed was vacuumed or siphoned out of the tank the next morning.

Other Information about the Raceways

Water exchange was maintained at 100 percent per 24 hours unless chemical treatment for disease required an overnight static condition.

A 500 μ m Nitex-screened internal standpipe kept PLs in the tank but allowed *Artemia* and other smaller materials to pass through. The level was set by an external standpipe. A small-screened bucket was placed under this external standpipe to catch the *Artemia*. The *Artemia* were occasionally returned to the raceway where they were fed one bottle of algae per day to try to make them a better food source.

A small screen was tried on the internal standpipe but it clogged occasionally and raised the water level in the tank so that the airlifts did not properly circulate the water.

Recommendations:

1. Use 500 μ m Nitex as described above.
2. Place habitats below water surface (keep in mind that the more habitats there are, the less circulation there will be unless more airlifts are added).
3. Feed *Artemia* longer if temperatures are below 28°C, plus or minus 1°C, because the animals are smaller and cannot swim to the bottom against the current and feed solely on pellets. If temperatures have been held at 28°C, the animals should be strong enough by PL11, as indicated by the feeding schedule, to stop feeding *Artemia*.

Chapter 9

The Hatchery As A Business

Introduction

The successful operation of a shrimp hatchery entails a combination of the following three key elements:

- Appropriate design and construction of the facility.
- The application of scientific techniques in order to produce at a necessary rate of survival.
- The application of management procedures in order to ensure ongoing operations.

This chapter concentrates on the third necessary element the management procedures necessary to maximize profit over time and ensure that the hatchery operates as a financially-healthy venture.

The Manager's Role

The hatchery manager's role is to turn the inputs (fixed inputs such as the land, building and machinery and variable inputs such as broodstock, feed, fuel and supplies) into the sale of postlarvae in such a way as to maximize profit. Put more simply, the hatchery manager's job is to maximize the difference between total costs and total revenues. Maximizing profit is not necessarily the same as maximizing production, nor is it the same as minimizing costs. It means selecting the rate and system of production that will produce the largest profit.

Many hatchery owners/operators are more familiar with the shrimp production system than with the management of a hatchery as a business. A hatchery's production system takes inputs and processes them in order to produce outputs. It takes broodstock or nauplii and matures them to produce postlarvae. In fact, the business/management side also has systems that work in a way similar to the production system. These business systems include the following:

- Planning
- Accounting
- Marketing

These systems take information from the hatchery management team as inputs. They then "process" the information, organizing and refining it and produce outputs of improved information. These outputs provide better communication which leads to better business decisions and improved business performance.

Planning

Through an annual planning and budgeting process, a hatchery makes conscious decisions as where to apply limited assets; it tries to do so in a way that harmonizes diverse aspects of the hatchery operation, directing them toward a small set of goals. As previously mentioned, the goal is to maximize profit. The hatchery manager must first plan the optimal production quantity based on cost

estimates and sales projections. For example, if a hatchery is capable of producing 1,000,000 PL20s but only projects sales of 750,000, a significant cost savings can be realized by cutting back production to 750,000. Production may be set at 800,000 or 850,000 to allow for sales-projection errors.

Another question to be evaluated is what the optimal sales make-up should be, i.e. should the hatchery push (or even allow) sales of PL5s or PL10s? To answer this "product mix" question, the manager must do a step-by-step evaluation of the hatchery's production components. Such an evaluation includes input quantity, survival rate, time-in-process and output quantity for each facet of the system. It must be determined how much the final-output quantity of PL5s could be sold for versus the additional cost of raising them to the PL20 stage before selling. With such information the manager can determine at what stage of growth sale of the PLs would be most profitable.

The **Business Plan** outlines the hatchery's upcoming year's goals and suggests specific action plans to achieve those goals. The **Annual Budget** evaluates the available resources in terms of capital, personnel and expertise, and directs the application of these resources. The manager must draw on information and estimates from all sources in order to assemble specific production, sales and profit goals that are at the same time ambitious and realistic.

A sample business plan that details an overall goal, specific goals and action plans to achieve those goals is illustrated below. Each hatchery's plan will vary with their individual needs but this sample plan should be a helpful guide.

Sample Annual Business Plan

Overall Goal: To produce high-quality postlarvae that will enhance the hatchery's profit margin.

Specific Goals

- Production — increase monthly production to an average of 300,000 to 500,000 postlarvae.
- Sales — sell all PLs produced October through February and sell 75 percent of PLs produced other months.
- Costs — reduce variable-input costs by 5 percent.
- Personnel — give workers a sense of "teamwork;" provide good, clean employee living quarters.
- Plant and equipment — paint interior and exterior of plant; institute routine maintenance of machinery.

Action Plans

- Production — add two permanent maturation tanks; sell excess nauplii to other hatcheries; purchase stand-by pump to cover breakdowns.
- Sales — during months when sales are less than production, the production manager will work in the

- field with prospective buyers for one week per month.
- Costs — sales trips for marketing will be coordinated with sales-delivery trips; business manager will seek volume discounts or long-term contract discounts on supplies and materials.
 - Personnel — institute monthly staff meetings during which managers brief workers on the hatchery's overall situation, soliciting the workers comments, complaints and suggestions.
 - Plant and equipment — schedule painting (interior and exterior) for hatchery's vacation month and include cost in annual budget; plant manager will outline detailed preventive-maintenance program for generator, pumps and water intake system.

Quarterly reviews of an annual business plan allow for adjusting goals due to altered expectations or problems that develop as well as keeping the goals evident and active. It is important to see the business plan as a guide, a map for the hatchery operations to follow; it allows all decision-makers at the hatchery to have common goals and a plan on how to attain them.

The annual budget is a process that sets out revenue and cost projections for the upcoming year. It sets out the best assumptions for the upcoming year's revenues, costs and profits. In order to do this, the manager must accumulate and evaluate information from the following areas:

- Production capacity — What is the hatchery's top capacity, i.e. how many post-larvae can the hatchery produce in a given month? Judging on the basis of the condition of the equipment and the dependability of supplies, what is the targeted expectation of "full capacity?" Is it in fact maximizing profit to run at full capacity?
- Production schedule — at what percentage of capacity will the hatchery choose to operate during given months, i.e. will the hatchery slow down production during slack months? Will the hatchery temporarily expand its full capacity during peak demand months by adding temporary supplemental raceways?
- Sales projections — how good is the ability of the hatchery to market the post-larvae? Will new buyers be solicited during the slack-demand season, and if so, what level of success is expected? Or, will lower sales be accepted during the periods of low demand?
- Cost estimates — what will be the hatchery's costs during the upcoming year? Will cost savings be realized through improved technology? Are feed and fuel prices expected to rise? Have any major capital purchases such as machinery or equipment been planned? A budget analysis for a shrimp hatchery unit and a maturation facility was written by Johns *et al.*, 1981 WAS 12(2) 305-321 and WAS 12(1) 104-189.

Accounting/Bookkeeping

The following flow chart explains hatchery capital flow. It shows that the owner/investor is responsible for the initial capital expenditure and additional capital investments that the hatchery is unable to cover from sales. The hatchery uses fixed and variable inputs to produce outputs (sales). Sales revenues are reinvested in the hatchery, covering variable inputs or returned to the owner

and/or investor as a return on investment. Accounting is a tool to chart this flow of investment. The arrows represent the flow of capital.

Hatchery Capital Flow

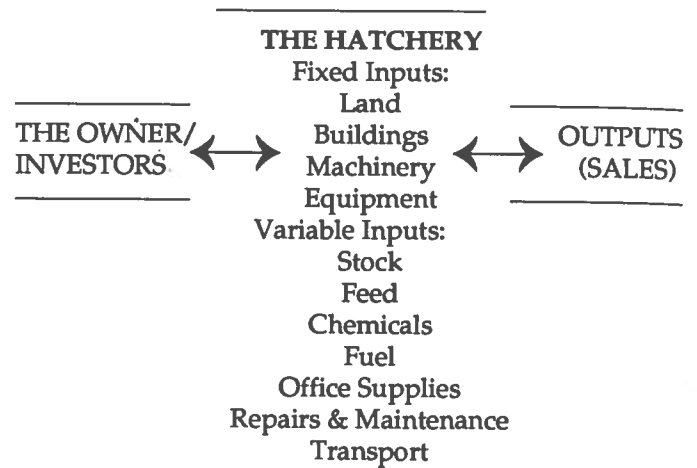

The Purpose of Accounting

Good records provide revenue and cost information to managers, letting them see where the hatchery's money is being spent. This knowledge then enables the manager to make better decisions regarding the control of those expenses. Internally, cost accounting allows for controls, pricing analyses, and establishes operational records for historically-based projections. Externally, financial accounting generates financial statements, helping the hatchery to gain credibility with investors and lenders.

The Monthly Profit and Loss Statement

The monthly profit and loss statement is used by the hatchery to monitor its business. This is done by noting the revenues gained through sales and then subtracting expenses to show the hatchery's monthly profit (or loss). A sample monthly profit and loss statement is shown. Like all examples used, it is merely illustrative and not meant to be indicative of the performance of any particular hatchery.

Notes on Operating Expenses

Labor expenses include salaries, bonuses and benefits given to the employees in payment for their services (include paid-out medical expenses the employees). This line item is used to evaluate how high (or low) a percentage of sales must be to cover labor costs. It is also used to compare labor costs with those of other hatcheries. While it is important to pay fair wages to attract and keep good employees, it is also important not to unilaterally escalate the pay scale.

Office expenses include office supplies, communication costs and marketing efforts. This line item tends to widely fluctuate. The main concern is to balance restrictions and limitations on spending with the flexibility of operation and the ease of getting the job done. While the office supplies component of this line item will remain more or less constant, communication and marketing costs may have larger seasonal variances.

Sample Monthly Profit and Loss Statement

January 1-31,
(All figures in '000 Rps.)
(1,000 rupiah = US \$ 1.17)

I. Sales:			
1. Cash sales	2050		
2. Credit sales	250	+	
			2300
3. Sales discount			<u>(50)</u> —
			2250
II. Operating expenses			
1. Labor expenses			200
2. Office expenses			150
3. Production expenses			500
4. Maintenance			100
5. Transportation			150
6. Miscellaneous expenses			<u>150</u> +
			<u>(1250)</u> —
			1000
III. Depreciation expenses			
1. Building			300
2. Machinery/equipment			200
3. Vehicle			<u>100</u> +
			<u>(600)</u> —
			400
Monthly operating profit (loss)			
400			
IV. Non-operating income and expenses			
1. Sales			100
2. Expenses			<u>(50)</u> —
			50
Monthly profit (loss)			
<u>450</u>			

Production expenses include such items as the mated females, feeds, fuel for the generator and other supplies directly related to production. This includes laboratory costs as well.

Maintenance covers upkeep on the buildings and repairs of machinery and equipment. Include such expenses as cleaning materials, paint and lubricants, repair costs and spare parts for machinery. Older machinery will require more repairs; at some point it will become more cost efficient to replace it with new equipment.

Transportation includes all public-transport costs as well as any vehicle expenses such as fuel, spare parts and repairs. This category will rise if the hatchery delivers its product to the tambak farmers or does marketing outreach.

The miscellaneous category is for representation, charitable contributions, bank charges, entertainment and whatever other "miscellaneous costs" the hatchery incurs during the month.

The Yearly Profit and Loss Statement

The yearly profit and loss statement is a compilation of the monthly profit and loss statements with an adjustment made for taxes that have been paid. This statement shows how well (or poorly) the business performed over the course of the past year. It is a cumulative statement. A sample annual profit and loss statement is on page 172.

The Annual Balance Sheet

The annual balance sheet is the second major annual financial statement. It is routinely produced at year's end, at the same time as the profit and loss statement. Unlike the profit and loss statement, which illustrates performance over a period of time, the balance sheet illustrates the state of the business at a moment in time. It is as if at midnight on the evening of December 31, all accounts were frozen and their status recorded. A sample annual balance sheet is on page 172.

Marketing

Marketing is the label given to the effort of selling a product. It brings to mind advertising campaigns with radio and newspaper announcements, but marketing is not limited to advertising; it encompasses such efforts as packaging, delivering and customer relations. The essence of marketing is knowing one's customer and convincing him/her that it is in their best interest to buy your product.

Packaging

A product that is effectively packaged is a good marketing tool. A good appearance can be presented by stamping the styrofoam containers with the hatchery's name or logo. Workers who sell the postlarvae to farmers should project professional capabilities, i.e. is their ap-

Sample Annual Profit and Loss Statement

January 1, - December 31,
(All figures are in '000 Rps.)
(1,000 rupiah = US \$1.17)

I. Sales			
1. Cash sales	24600		
2. Credit sales	<u>3000</u> +		
		27600	
3. Sales discount		<u>(600)</u> —	
			27000
II. Operating expenses			
1. Labour expenses		2400	
2. Office expenses		1800	
3. Production expenses		6000	
4. Maintenance		1200	
5. Transportation		1800	
6. Miscellaneous expenses		<u>1800</u> +	
			<u>(15000)</u> —
			12000
III. Depreciation			
1. Building		3600	
2. Machinery/equipment		2400	
3. Vehicle		<u>1200</u> +	
			<u>(7200)</u> —
	Net-operating profit (loss)		4800
IV. Non-operating income and expenses			
1. Sales		100	
2. Expenses		<u>(50)</u> —	
			<u>50</u>
	Net-operating profit (loss) before taxes		4850
V. Taxes			
			<u>850</u>
	Net-operating profit (loss) after taxes		<u>4000</u>

Sample Annual Balance Sheet

December 31,
(All figures are in '000Rps)
(1,000 rupiah = US\$1.17)

Current assets		Liabilities	
1. Cash	600	Acct. payable	580
2. Account receivable	400		
3. Supplies	<u>2500</u>		
Total current assets	<u>3500</u>	Owner's equity	<u>21000</u>
Fixed assets			
1. Land	8000		
2. Building	7200	Total liabilities and	
Accumulated depreciation expenses	<u>(360)</u>	owner's equity	
	6840		
3. Machinery/equipment	2400		
Accumulated depreciation expense	<u>(240)</u>		<u>21580</u>
	2160		
4. Vehicle	1200		
Accumulated depreciation expenses.	<u>(120)</u>		
	<u>1080</u>		
Total fixed assets	<u>18080</u>		
Total assets	<u>21580</u>		

pearance and manner consistent with the delivery of a quality product?

Delivery

An important part of marketing postlarvae is the actual delivery to the pond. Clear efforts to ensure that the product arrives healthy is very important. Clear efforts mean that the buyer is aware of the measures the hatchery takes to ensure healthy delivery. The delivery vehicle can carry the hatchery's name and logo for free and effective advertising.

Customer Relations

It is critical that the hatchery establish good relations with the farmers who are its customers. Not only is this necessary to ensure continued sales, it has the power to increase sales if present buyers advise their colleagues to also buy from you. The best way to make this happen is to deliver a quality product at the right price on a dependable basis. This means that postlarvae must be healthy and attractive, sold at market or below market prices and a good supply must be available when a buyer seeks it.

When To Do Marketing

When production exceeds sales there is a need for marketing. If there is more demand than the hatchery is able to supply, an additional marketing effort is not needed. In the common situation of seasonal demand, marketing is only needed during the low-demand season.

How Much Is Necessary

How extensive (and expensive) a marketing job the hatchery needs is defined by the value of the currently unsold shrimp, the available resources for the effort (people and capital), and the likelihood of a favorable response to the marketing effort (are buyers simply waiting to be convinced?).

Types of Marketing

Direct contact with the farmers who are prospective buyers is the simplest and probably the most effective type of marketing. It costs the hatchery time and travel expenses for management personnel and is most warranted during the low-demand season.

Such measures as a hatchery logo or the hatchery's name on the packages, delivery vehicles and/or clothing of workers dealing with the public is often effective. A simple, eye-catching design is easily remembered by buyers and others who see it.

Summary

The manager's role is to convert inputs into outputs in a way that optimizes profit over time. The manager should not assume that maximizing production is going to maximize profit.

Planning is the process in which the manager clarifies the goals for the hatchery and determines the means by which to achieve them. A business plan details the actions necessary to achieve specific goals. The annual budget outlines sales and cost figures for the upcoming year, coordinates realistic projections into a single document and authorizes the allocation of resources.

Accounting charts the capital flow from the investors into the hatchery and back. Internally-oriented cost accounting traces the hatchery's use of funds. Externally-oriented financial accounting contributes financial statements that chart the overall performance of the hatchery as a business. The profit and loss statements monitor performance on a monthly basis to keep a close watch on progress and annually to evaluate the past year's performance. The balance sheet provides a profile of the state of the business at year's end.

Marketing basically amounts to the distribution of postlarvae to the consumer at a price greater than the cost. Every hatchery does marketing of some kind. The packaging and selling of the product is marketing; so is sending a hatchery employee out to educate farmers of the benefits of hatchery postlarvae. Through farmer education and advertising, the hatchery can increase its sales.

An appropriate facility and a good production system are necessary but they are not enough. The hatchery must have effective financial planning. By concentrating on planning the correct application of funds and personnel, monitoring the distribution and expense of these resources and efficiently delivering a quality product to the consumers, the hatchery manager can best maximize profit over time. This will ensure the continued financial success of the hatchery.

The following pages are examples of typical cash outflow for start-up construction and operation of a 10 million larvae per month hatchery in the country of Ecuador follows (prices are in U.S. dollars).

Hatchery Cash Flow Example

Development Costs for a Maturation/Hatchery Facility to Produce 10 Million PL/mo. in Ecuador
Cash Outflow for Construction and Design

	Quantity	1 Year		Economic Life (years)	Sum Life
		Price (US\$)	Total		
SHOP EQUIPMENT					
Table Saw 10	1	580	580	10	
Drill Press	1	200	200	10	
Grinder	1	200	200	10	
Welder	1	300	300	10	
Torch	1	190	190	10	
Vise	1	65	65	10	1535
Generator (large)	1	10000	10000	8	
Air Compressor	1	450	450	7	
Battery Charger	1	50	50	7	
Jack 12 Ton	1	175	175	7	
Wheelbarrow	1	50	50	7	
Hand Tools	1	2000	2000	7	
Gen. Supplies	1	300	300	7	
Generator (small)	2	500	1000	7	4025
Hand Drill 3/8	1	120	120	3	
Drill 1/2	1	100	100	3	
Jigsaw	1	100	100	3	
Circular	1	150	150	3	
Ladder	1	50	50	3	
Miscellaneous	1	2000	2000	3	2520
SUBTOTAL			18080		
OFFICE					
Desk & Chair	1	300	300	12	
Conference Table	1	400	400	12	
Conference Chairs	4	30	120	12	
Blackboard	1	70	70	12	
Bookshelves	0	150	0	12	
Filing Cabinet	1	100	100	12	990
Computer	1	5000	5000	6	
Typewriter	1	300	300	6	5300
Radio	1	3000	3000	5	
Slide Projector	0	200	0	5	
Copy Machine	1	2500	2500	5	
Calculator	1	75	75	5	
Air Conditioning	2	500	1000	5	
Miscellaneous	1	901	901	5	7476
SUBTOTAL			13766		
LAND AND BUILDINGS					
Land (Ha)	2	20000	40000		
Buildings (Mat/Hatch)	20000	9	180000	20	
Staff Housing	2	25000	50000		
Miscellaneous	1	2250	2250	20	
SUBTOTAL			272250		
MATURATION EQUIPMENT					
Tanks (5MT)	10	2200	22000	15	
PVC Pipe	1	3500	3500	15	2550
Food Processor	1	90	90	10	
Spectrophotometer	1	1100	1100	10	
Pipets	2	75	150	10	
Air Collar	1	1100	1100	10	
Freezer	1	1500	1500	10	

Cash Outflow for Construction and Design (cont)

Misc. Lab	1	8000	8000	10	11940
Lighting	18	350	6300	7	
Small Pumps Utility	3	100	300	7	
O2 Meters	1	1100	1100	7	
Refractometer	2	300	600	7	
Triple Beam Balance	1	125	125	7	
Balance K	1	1600	1600	7	
Microscopes	2	900	1800	7	
Biofilter	22	500	11000	7	
Hemacytometer	2	90	180	7	
Miscellaneous	1	4231	<u>4231</u>	7	27236
SUBTOTAL			64676		
WATER SYSTEM					
Pipe Line	1	8000	8000		
Tanks (settling)	2	5000	10000	15	
Tank (storage)	1	10000	10000		
Water Heater Exchanger	1	2000	2000	10	
Solar Panels	15	90	1350		
UV Light	4	300	1200	10	4550
Pumps	1	400	400	9	
Filters	30	150	4500	9	
Plastic Tubing	1	2000	2000	9	
Miscellaneous	1	2762	<u>2762</u>	9	9662
SUBTOTAL			42212		
HATCHERY EQUIPMENT					
Tanks (10MT)	12	1000	12000	15	
Algae Tanks	15	180	2700	15	
PVC Pipe	1	3500	3500	15	18200
Air Conditioner	1	300	300	7	
Carboy Rack	1	150	150	7	
Aeration Blower	4	150	600	5	
Refrigerator	1	600	600	5	
Ph Meter	1	300	300	5	
Carboys Plastic	20	60	1200	5	
Carboys Glass	10	100	1000	5	
Miscellaneous	1	1565	<u>1565</u>	5	5265
SUBTOTAL			23915		
TRANSPORTATION					
Truck (1 ton)	2	15000	30000	5	
Hauling Tanks	2	500	<u>1000</u>	10	
SUBTOTAL			31000		
ANNUAL TOTAL			465898		

Monthly Cash Flow

Mat/Hat facility producing 10 mil/mo in 1.5 runs/mo.

	Jan	Feb	Mar	Apr	May	June	July	Aug	Sept	Oct	Nov	Dec
BEGINNING CASH	200000	334031	250596	164486	81051	10000	10001	4929	20957	12917	29299	84792
BALANCE INCOME												
Sale PL (\$12.00/1000)							24000	48000	74400	74400	74400	74400
TOTAL CASH INFLOW	200000	334031	250596	164486	81051	10000	34001	52929	95357	87317	103699	
159192												
CAPITAL OUTLAY												
Land	40000	0	0	0	0	0	0	0	0	0	0	0
Shop Equipment	3013	3013	3013	3013	3013	3013	0	0	0	0	0	0
Office Equipment	2294	2294	2294	2294	2294	2294	0	0	0	0	0	0
Bldg. Construction	38708	38708	38708	38708	38708	38708	0	0	0	0	0	0
Maturation Equipment	10779	10779	10779	10779	10779	10779	0	0	0	0	0	0
Water System	7035	7035	7035	7035	7035	7035	0	0	0	0	0	0
Hatch Equipment	3986	3986	3986	3986	3986	3986	0	0	0	0	0	0
TOTAL	105816	65816	65816	65816	65816	65816	0	0	0	0	0	0
OPERATING EXPENSES												
Fuel	200	200	200	200	200	200	200	200	200	200	200	200
Cons Repair	1316	1316	1316	1316	1316	1316	0	0	0	0	0	0
Insur Machines	5000	0	0	0	0	0	0	0	0	0	0	0
Labor (\$350./mo/labor)	3500	3500	3500	3500	3500	3500	3500	3500	3500	3500	3500	3500
Utilities (\$0.24/kwh)	2180	2180	2180	2180	2180	2180	2180	2180	2180	2180	2180	2180
Telephone	200	200	200	200	200	200	200	200	200	200	200	200
Supplies	500	500	500	500	500	500	500	500	500	500	500	500
Payroll Taxes (15%)	525	525	525	525	525	525	525	525	525	525	525	525
Social Security (7%)	245	245	245	245	245	245	245	245	245	245	245	245
Travel	300	300	300	300	300	300	300	300	300	300	300	300
Broodstock (\$10/animal)	0	0	0	0	0	0	9500	0	0	9500	0	0
Feed (Broodstock 7.2/yr)	0	0	0	0	0	0	1140	1140	1140	1140	1140	1140
Supplemental Feed	0	0	0	0	0	0	100	100	100	100	100	100
<i>Artemia</i>	0	0	0	0	0	0	180	180	180	180	180	180
Chemicals	0	0	0	0	0	0	200	200	200	200	200	200
Antibiotics	0	0	0	0	0	0	600	600	600	600	600	600
Other	0	0	0	0	0	0	300	300	300	300	300	300
TOTAL OPERATING EXP	13966	8966	8966	8966	8966	8966	19670	10170	10170	19670	10170	10170
FIXED COSTS												
Permits	2000	0	0	0	0	0	0	0	0	0	0	0
M/H Manager	3000	3000	3000	3000	3000	3000	3000	3000	3000	3000	3000	3000
Biologists (2)	3000	3000	3000	3000	3000	3000	3000	3000	3000	3000	3000	3000
Fringe Benefits: 25%	1500	1500	1500	1500	1500	1500	1500	1500	1500	1500	1500	1500
Property Tax (11%)	880	0	0	0	0	0	0	0	0	0	0	0
Legal & Accounting	0	0	2500	0	0	2500	0	0	2500	0	0	2500
Miscellaneous Expenses	1704	1153	1328	1153	1153	1328	1902	1237	1412	1902	1237	1412
TOTAL FIXED COST	12084	8653	11328	8653	8653	11328	9402	8737	11412	9402	8737	11412
SCHEDULED DEBT PAYMENTS												
Intermediate-Principal	0	0	0	0	0	0	0	0	0	0	0	34356
-Interest	0	0	0	0	0	0	0	0	0	0	0	58497
Long Term -Principal	0	0	0	0	0	0	0	0	0	0	0	0
-Interest	0	0	0	0	0	0	0	0	0	0	0	0
TOTAL CASH OUT	131867	83435	86110	83435	83435	86110	29072	18907	21582	29072	18907	21582
TOTAL CASH AVAIL	68133	250596	164486	81051	-2384	-76109	4929	34022	73775	58245	84792	137610

Monthly Cash Flow (cont)

NEW BORROWING												
Short Term	0	0	0	0	12384	86110	0	0	0	0	0	0
Intermediate	265898	0	0	0	0	0	0	0	0	0	0	0
Long Term	0	0	0	0	0	0	0	0	0	0	0	0
Total New Borrowing	265898	0	0	0	12384	86110	0	0	0	0	0	0
PAYMENTS SHORT TERM DEBT												
Principal	0	0	0	0	0	0	0	12384	57685	28425	0	0
Interest	0	0	0	0	0	0	0	681	3173	521	0	0
TOTAL SHORT TERM PA	0	0	0	0	0	0	0	13065	60858	28946	0	0
ENDING CASH BALANCE	334031	250596	164486	81051	10000	10001	4929	20957	12917	29299	84792	137610
SUMMARY DEBT OUTSTANDING												
Short Term	0	0	0	0	12384	102260	102260	86110	28425	0	0	0
Intermediate	265898	265898	265898	265898	265898	265898	265898	265898	265898	265898	265898	231542
Long Term	0	0	0	0	0	0	0	0	0	0	0	0

INCOME STATEMENT

SUMMARY OF INCOME FOR 1988 - 1991

CASH INCOME	<u>FIRST YEAR</u>				
<u>1990</u> <u>1991</u>			<u>1988</u>	<u>1989</u>	
PL Sales (12/1000)	369600		892800	1152000	1152000
TOTAL CASH INCOME	369600		892800	1152000	1152000
CASH EXPENSES					
VARIABLE EXPENSES					
Hatchery	16916		14232	14232	14232
Broodstock	19000		38000	38000	38000
Feed	8520		18180	18180	18180
Fuel	2400		2400	2400	2400
Maintenance (repairs)	7898		3000	3000	3000
Utilities (tel; elect.)	28560		28560	28560	28560
Labor	42000		42000	42000	42000
Other	1800		3600	3600	3600
TOTAL VARIABLE EXPENSES	127094		149972	149972	149972
FIXED EXPENSES					
Property taxes	880		880	880	880
Insurance	5000		5000	5000	5000
Interest on Debt	58497		50939	41718	16744
Manager	36000		36000	36000	36000
Assistant Biologists	36000		36000	36000	36000
TOTAL FIXED EXPENSES	136377		128819	119598	94624
TOTAL CASH EXPENSES	263471		278791	269570	244596
NET INCOME	106129		614009	882430	907404
NONCASH ADJUSTMENTS:					
DEPRECIATION					
Mach. and Equip.	18062		18062	18062	18062
Buildings	6500		6500	6500	6500
TOTAL DEPRECIATION	24562		24562	24562	24562
INVENTORY CHANGE					
Supplies	0		0	0	0
NET INVENTORY CHANGE	0		0	0	0

SUMMARY OF INCOME FOR 1988 - 1991

<u>FIRST YEAR</u>	<u>1988</u>	<u>1989</u>	<u>1990</u>	<u>1991</u>
<u>TOTAL</u>	<u>TOTAL</u>	<u>TOTAL</u>	<u>TOTAL</u>	<u>TOTAL</u>
137610	137610	661961	1445512	2229063
369600	892800	1152000	1152000	1152000
1572659	1030410	1813961	2597512	3381063
40000	0	0	0	0
18080	0	0	0	0
13766	0	0	0	0
232248	0	0	0	0
64676	0	0	0	0
42212	0	0	0	0
23915	0	0	0	0
434896	0	0	0	0
2400	2400	2400	2400	2400
7898	3000	3000	3000	3000
5000	5000	5000	5000	5000
42000	42000	42000	42000	42000
26160	26160	26160	26160	26160
2400	2400	2400	2400	2400
6000	6000	6000	6000	6000
6300	3156	3156	3156	3156
2940	1476	1476	1476	1476
3600	3600	3600	3600	3600
19000	38000	38000	38000	38000
6840	13680	13680	13680	13680
600	2000	2000	2000	2000
1080	2500	2500	2500	2500
1200	2400	2400	2400	2400
3600	7200	7200	7200	7200
1800	3600	3600	3600	3600
138818	164572	164572	164572	164572
2000	0	0	0	0
36000	36000	36000	36000	36000
36000	36000	36000	36000	36000
18000	18000	18000	18000	18000
880	880	880	880	880
10000	5000	5000	5000	5000
16919	15144	15144	15144	15144
119799	111024	111024	111024	111024
34356	41914	51135	62384	76109
58497	50939	41718	30469	16744
0	0	0	0	0
0	0	0	0	0
693513	368449	368449	368449	368449
879146	661961	1445512	2229063	3012614
98494	0	0	0	0
265898	0	0	0	0
0	0	0	0	0
364392	0	0	0	0
98494	0	0	0	0
4375	0	0	0	0
102869	0	0	0	0
137610	661961	1445512	2229063	3012614
0	0	0	0	0
231542	189628	138493	76109	0
0	0	0	0	0

The following section includes a description, production summary and proforma income statement for a large hatchery from 1980 and projected through 1995.

Large United States Hatchery Description

The primary business objective is the production of shrimp for sale as food. The species exclusively used is the Pacific white shrimp (*P. vannamei*). The current market is entirely in the continental United States. They also sell nauplii and postlarval shrimp to other shrimp farms in the United States, Central and South America.

The hatchery also supports 450 acres of grow-out pond. These range in size from 0.25 acre experimental ponds to the largest pond of 43 acres. There are ten nursery/grow-out pond combinations. The nursery ponds range in size from six to nine acres and the adjacent grow-out ponds range from 26 to 43 acres. There are two large grow-out ponds without adjacent nurseries.

The current maturation complex consists of 24 circular tanks supported by extensive biofilter and water-treatment facilities. There also is an indoor-raceway system capable of holding 1,000 brood. Using one 12-tank room for production with the second room as backup, the current nauplii production capacity is 2.5 million nauplii per day.

The larval-rearing section has 29 fiberglass tanks with a total water capacity of 310 tons. These range in size from 9,000 liters to 20,000 liters. In 1989 they were able to increase their survival rate from Nauplii to PL8 to an average of 70 percent. This has been accomplished simultaneously with a decrease in the use of antibiotics. Although the hatchery was not run at full capacity in 1989, full production was 25 million postlarvae per month in 1990. Full production was 20 million per month in 1988 when average nauplii survival to PL8 was 45 percent. By adding tanks in existing space and adding vessels to the existing algae-production room, the PL production capacity was increased by another 5 million per month without a substantial capital investment.

The hatchery also has an comprehensive water-treatment facility. This allows the facility to handle all but the most severe water quality variations.

The maturation, larval-rearing, and water-treatment facilities, as well as the administrative offices, are housed in a 48,000 square foot concrete building. The building was constructed in 1985, is positioned 18 feet above sea level and satisfies all coastal-building codes.

This will be the fourth year of operation for the 450 acre grow-out complex. Prior to 1986 the total acreage of ponds

had been gradually increased while management experimented with variations in pond size and design, stocking density and strategy as well as various techniques of feeding and distribution, water-exchange rates, and mechanical aeration.

Brood shrimp were selected from the ponds in 1983 and wintered for 1984 production. Late in 1983, a 30,000 square feet hatchery complex was constructed that included water treatment, maturation and 165 metric-ton larval-rearing areas. In late 1984 the maturation capacity was doubled in size and a brood-holding facility was constructed. This expansion increased the facility to its present size of 40,000 square feet.

In 1985 the larval-rearing tank capacity was increased to 230 tons. In 1986 the larval-rearing capacity was increased to 270 tons. In 1987 another expansion increased the larval-rearing capacity to 310 tons. In 1990 they increased the larval-rearing capacity to 370 tons. PL8-10 production at this rearing volume was 25 million per month. In late 1988 a research greenhouse facility was built to test head-starting postlarvae in 1989. As detailed below in postlarval disposition, the end production of the hatchery has progressed from PL2-3s in 1983 to PL8-10s in 1987 and 1988. The hatchery was sold to a new group in 1990.

Large Hatchery Postlarval Disposition

1982	No records
1983	10 million postlarvae 2-3s produced 10 million postlarvae 2-3s stocked
1984	26 million postlarvae 4s produced 20 million postlarvae 4s stocked 6 million postlarvae 4s sold
1985	35 million postlarvae 4-5s produced 23 million postlarvae 4-5s stocked 11 million postlarvae 4-5s sold 1 million postlarvae 4-5s research
1986	39 million postlarvae 5-6s produced 34 million postlarvae 5-6s stocked 3 million postlarvae 5-6s sold 2 million postlarvae 5-6s research
1987	122 million postlarvae 8-10s produced 54 million postlarvae 8-10s stocked 27 million postlarvae 8-10s sold 41 million postlarvae 8-10s research
1988	112 million postlarvae 8-10s produced 58 million postlarvae 8-10s stocked 10 million postlarvae 8-10s sold 44 million postlarvae 8-10s research

Large Hatchery Production Summary

Year	Nauplii Stocked (millions)	PLs Harvested	Overall Percent Survival	Pond Stocking Duration
1983	40.0	10.0	23%	Apr-Sep
1984	116.6	26.4	23%	Mar-Aug
1985	584.5	35.1	6%	Feb-Aug
1986	333.5	39.3	12%	Mar-Aug
1987	270.4	121.7	45%	Mar-June
1988	313.0	112.0	36%	Mar-June
1989	53.0	37.0	70%	Apr-June
1990		230.0 (estimate sales Feb-Sept 1990)		

Diseases encountered in the hatchery included bacterial infestations, fungus and filamentous-bacterial problems and a viral infection. Most of these diseases became problems when there were stresses on the animals caused by water, food, systems, or managerial problems. Correction of these stress-producing problems resulted in reduced incidence of disease.

Antibiotics and water sterilization are used to keep bacterial problems under control. Further investigations are underway to combat viral infections.

Large Hatchery Postlarvae Costs

Year	Stocking Density (1000) (PLs)	Acres	Total PLs (1000's)	Total \$ /1000	PLs
1989	150	98	14,700	\$5.00	\$73,500
1990	150	250	37,500	\$5.00	\$187,500
1991	165	643	106,095	\$5.00	\$530,475
1992	182	643	116,705	\$5.00	\$583,523
1993	200	643	128,600	\$5.00	\$643,000
1994	200	643	128,600	\$5.00	\$643,000
1995	200	643	128,600	\$5.00	\$643,000

Assumptions: 1. Stocking density will be increased 10 percent per year until 200,000/acre.
2. Postlarvae costs will remain constant at \$5/1,000 (transfer rate from company hatchery)

Large Hatchery Postlarvae Production and Disposition by Month in 1990

Month	Local Production	Central Ponds	Other Local America	OUTSIDE SALES			Excess
				Sales	S. Carolina	Mexico	
Jan	0.0						0.0
Feb	10.0		(5.0)			(5.0)	0.0
Mar	20.0	(5.0)		(5.0)		(10.0)	0.0
Apr	25.0	(15.0)		(10.0)			0.0
May	25.0	(15.0)		(10.0)			0.0
June	25.0	(2.5)		(10.0)	(12.5)		0.0
July	25.0		(25.0)				0.0
Aug						(10.0)	15.0
Sep	25.0					(10.0)	15.0
Oct	25.0					(10.0)	15.0
Nov	25.0		(25.0)				0.0
Dec	0.0						0.0
	230.0	(37.5)	(55.0)	(35.0)	(12.5)	(45.0)	45.0

Actual and Projected Large Hatchery Operating Costs 1989-1995

	1989	1990	1991	1992	1993	1994	1995
Personnel							
Biologists (2) @ 21,000	18,000	42,000	44,100	46,305	48,620	51,051	53,064
Biologist			22,050	23,153	24,310	25,526	26,802
Algae Technicians (2) @ 16,000	16,000	16,800	17,640	18,522	19,448	20,421	21,442
Worker/Technicians (10) @ 5.75/HR	28,700	30,135	31,642	33,224	34,885	36,629	38,461
Worker/Technicians (3)		45,203	47,463	49,836	52,328	54,944	57,691
Worker/Technicians (2)			31,642	33,224	34,885	61,061	64,115
Maturation Specialist (5) @ 5.75/HR	15,000	15,750	16,538	17,364	18,233	19,144	20,101
Maturation Spec		15,750	16,538	17,364	18,233	19,144	20,101
Water Supervisor @ 19,000	19,000	19,950	20,948	21,995	23,095	24,249	25,462
	<u>96,700</u>	<u>185,588</u>	<u>248,559</u>	<u>260,987</u>	<u>274,036</u>	<u>312,170</u>	<u>327,778</u>
Feeds							
Nauplii	30,000	75,000	86,625	90,956	95,504	100,279	105,293
Post Larvae	<u>7,000</u>	<u>17,500</u>	<u>22,969</u>	<u>24,117</u>	<u>25,323</u>	<u>26,589</u>	<u>27,919</u>
	<u>37,000</u>	<u>38,850</u>	<u>109,594</u>	<u>115,073</u>	<u>120,827</u>	<u>126,868</u>	<u>133,212</u>
Utilities							
Water	21,000	22,050	28,941	30,338	31,907	33,502	35,178
Nauplii	25,200	26,460	34,729	36,465	38,288	40,203	42,213
Post Larvae	<u>11,550</u>	<u>12,128</u>	<u>15,917</u>	<u>16,713</u>	<u>17,549</u>	<u>18,426</u>	<u>19,348</u>
	<u>57,750</u>	<u>60,638</u>	<u>79,587</u>	<u>83,566</u>	<u>87,744</u>	<u>92,132</u>	<u>96,738</u>
Supplies							
Water	20,000	50,000	65,265	68,906	72,352	75,969	79,768
Nauplii	3,000	7,500	9,844	10,336	10,853	11,395	11,965
Post Larvae	<u>6,000</u>	<u>15,000</u>	<u>19,688</u>	<u>20,672</u>	<u>21,705</u>	<u>22,791</u>	<u>23,930</u>
	<u>29,000</u>	<u>30,450</u>	<u>95,156</u>	<u>99,914</u>	<u>104,910</u>	<u>110,155</u>	<u>115,663</u>
Maintenance							
Water	7,500	15,000	17,325	18,191	19,101	20,056	21,059
Nauplii	6,000	12,000	13,860	14,553	15,281	16,045	16,847
Post Larvae	<u>4,500</u>	<u>9,000</u>	<u>10,395</u>	<u>10,915</u>	<u>11,460</u>	<u>12,034</u>	<u>12,635</u>
	<u>18,000</u>	<u>18,900</u>	<u>41,580</u>	<u>43,659</u>	<u>45,842</u>	<u>48,134</u>	<u>50,541</u>
Total Yearly Operating Costs	<u>238,450</u>	<u>334,425</u>	<u>574,476</u>	<u>603,199</u>	<u>633,359</u>	<u>689,459</u>	<u>723,932</u>
Pls to Ponds (\$5/1,000)	(73,500)	(187,500)	(530,475)	(583,523)	(643,000)	(643,000)	(643,000)
PI Sales Central America (\$7/1,000)	(38,500)	(385,000)					
Nauplii Sales (\$1/1,000)			(90,000)	(135,000)	(180,000)	(225,000)	(225,000)
PI Sales Outside (\$7/1,000)	<u>(144,000)</u>	<u>(647,500)</u>	<u>(647,500)</u>	<u>(647,500)</u>	<u>(647,500)</u>	<u>(647,500)</u>	<u>(647,500)</u>
Nauplii Sales Outside							
Unallocated Hatchery Costs	<u>(17,550)</u>	<u>(885,575)</u>	<u>(693,499)</u>	<u>(762,823)</u>	<u>(837,141)</u>	<u>(826,041)</u>	<u>(791,568)</u>

**1990-91 Equipment Price List for Central American Shrimp Hatchery (in U.S. \$) with a
Production Capacity of 10 Million Postlarvae per Month**

DESCRIPTION	UNIT PRICE (US\$)	UNITS	EXTENDED PRICE (US\$)
SEAWATER TREATMENT SYSTEM (TREATMENT EQUIPMENT)			
Intake Screens	250.00	2.00	500.00
Hatchery Pumps	1000.00	3.00	3000.00
Hydrocyclone Separators	1500.00	2.00	3000.00
Rapid Sand Filters (140 gpm)	831.00	3.00	2493.00
Pall Filters, 1.0 um	5000.00	1.00	5000.00
Contact Columns, 8.0 MT	2000.00	4.00	8000.00
UV Sterilizers	4500.00	2.00	9000.00
Ozone Generator, PH490	11315.00	1.00	11315.00
Spare Lamps	500.00	6.00	3000.00
Spare Quartz Sleeves	400.00	2.00	800.00
Spare Ballasts	500.00	4.00	2000.00
Compressor, Thomas	580.00	2.00	1160.00
Hydraulic Flowmeters	65.00	7.00	455.00
Pneumatic Flowmeters	40.00	4.00	160.00
Ozone Diffusors	250.00	4.00	1000.00
			TOTAL 50883.00
SEAWATER TREATMENT (PVC, VALVES, FITTINGS, ETC.)			
2" PVC Flange	7.26	13.00	94.38
2" PVC Pipe	\$73/100ft	288.00	210.24
2" PVC Ell 90	1.02	33.00	33.66
2" PVC Ball Valve	23.62	20.00	472.40
442 Red Tee	10.69	17.00	181.73
4" PVC Pipe	\$213/100ft	60.00	127.80
4" PVC Tee	11.22	4.00	44.88
4" PVC Caps	4.16	8.00	33.28
4" PVC Ball Valve	155.22	4.00	620.88
4" PVC Ell 90	7.21	2.00	14.42
2" PVC Tee	1.26	4.00	5.04
2" PVC Caps	0.52	11.00	5.72
1/2" PVC Flanges	3.07	4.00	12.28
Ozone Tubing	\$254/100ft	100.00	254.00
Ozone Diffusors	256.00	4.00	1024.00
1/2" PVC Valves	6.98	4.00	27.92
1/2" PVC Pipe	\$25/100ft	100.00	25.00
Condensation Trap	100.00	2.00	200.00
			TOTAL 3387.63
HATCHERY SEAWATER DISTRIBUTION			
12.0 MT Header Tank	2000.00	1.00	2000.00
4" PVC Pipe	\$213/100ft	310.00	660.30
4" PVC Ell 90	6.66	13.00	86.58
4" PVC Flanges	11.06	8.00	88.48
441 Red Tee	9.88	7.00	69.16
4X1 Red Bushing	5.00	2.00	10.00
4" PVC Cap	4.16	1.00	4.16
442 Red Tee	9.88	5.00	49.40
2" PVC Pipe	\$73/100ft	460.00	335.80
221 Red Tee	1.35	45.00	60.75

DESCRIPTION	UNIT PRICE (US\$)	UNITS	EXTENDED PRICE (US\$)
HATCHERY SEAWATER DISTRIBUTION con't.			
112 Red Tee	2.78	2.00	5.56
2" PVC Tee	1.26	9.00	11.34
2" PVC Ell 90	1.02	15.00	15.30
1" PVC Pipe	\$35.33/100ft	450.00	158.99
1" PVC Ell 90	0.35	36.00	12.60
1" PVC Cap	0.29	32.00	9.28
1" PVC Ball Valve	10.40	50.00	520.00
1" PVC Tee	0.46	6.00	2.76
Hydraulic Flowmeters	60.00	6.00	360.00
			TOTAL 4460.46
HATCHERY AERATION (MAIN BLOWER)			
Main Air Blowers	1500.00	2.00	3000.00
3" PVC Ball Valves	75.60	3.00	226.80
3" PVC Pipe	\$152/100ft	500.00	760.00
3" PVC Tee	5.94	6.00	35.64
3" PVC Ell 90	3.72	6.00	22.32
332 Red Tee	5.94	6.00	35.64
2" PVC Tee	1.26	14.00	17.64
2" PVC Ell 90	1.02	18.00	18.36
221 Red Tee	1.35	12.00	16.20
2" PVC Pipe	\$73/100ft	250.00	182.50
2" PVC Ball Valves	23.62	4.00	94.48
2" PVC Caps	0.52	8.00	4.16
1" PVC Pipe	\$35.33/100ft	150.00	60.00
1" PVC Ball Valves	10.40	16.00	166.40
1" PVC Ell 90	0.35	16.00	5.60
2.5" Plastipore	\$41.12/3ft	168.00	2302.72
1/2" Thr Hosebarb	0.25	22.00	5.50
1/2" id Tygon Tubing	\$197/200ft	200.00	197.00
1/2" PVC Ball Valve	6.98	22.00	153.56
1"X3" Airstones	2.80	40.00	112.00
3/16" Tygon Tubing	\$67.88/100ft	200.00	135.76
3/16" Thr Hosebarb	0.25	30.00	7.50
3/16" In-Line Valves	0.50	30.00	15.00
Blower Air Filter	100.00	2.00	200.00
Sidestream Injection Arr.	200.00	1.00	200.00
			TOTAL 7974.78
HATCHERY BLOWER AERATION (ALGAE CULTURE FACILITY, LAB)			
Air Blowers	1000.00	2.00	2000.00
Blower Filters	100.00	2.00	200.00
2" PVC Pipe	\$73/100ft	1000.00	730.00
2" PVC Tees	1.26	26.00	32.76
2" PVC Ell 90	1.02	20.00	20.40
3/16" Mipt	0.25	100.00	25.00
3/16" Tygon Tubing	\$67.88/100ft	1000.00	678.80
3/16" Valves	0.50	200.00	100.00
1"X2" Airstones	2.00	300.00	600.00
2" PVC Caps	0.52	1.00	0.52
3/16" PVC Four-Way	0.63	40.00	25.20
3/16" Ell 90	0.32	80.00	25.60
			TOTAL 4438.28

UNIT DESCRIPTION	PRICE (US\$)	UNITS	EXTENDED PRICE (US\$)
HATCHERY MATURATION FACILITY (MAT ROOM, LAB, SPAWNING)			
Maturation Tanks, 12ft. diam.	1000.00	6.00	6000.00
Overhead Lightbanks	100.00	6.00	600.00
Dip nets	16.84	6.00	101.04
Egg Collectors	20.00	6.00	120.00
Portable/subm Flashlight	100.00	2.00	200.00
Center Screen Standpipes	40.00	6.00	240.00
20 gal. Batch Cans	63.62	4.00	254.48
Pool Vacuum Kit	150.00	1.00	150.00
Hand Pump, Large Capacity	167.51	2.00	335.02
Assorted Brushes	NA	NA	100.00
Salinometer/Refractometer	360.00	1.00	360.00
Thermometers, Assorted	NA	NA	100.00
Dissecting Microscope	610.00	1.00	610.00
Dissecting Kit	48.50	2.00	97.00
HACH Ammonia Test Kit	100.00	1.00	100.00
Top Loading Balance	1195.00	1.00	1195.00
Triple Beam Balance	181.65	1.00	181.65
Refrigerator	750.00	1.00	750.00
Box Freezer	600.00	1.00	600.00
1.0 qt. Containers, Plastic	1.14	120.00	136.80
Assorted Glassware	NA	NA	300.00
Magnetic Stirrer	172.50	1.00	172.50
Spawning Tanks, Fiberg.	150.00	16.00	2400.00
Plastic Buckets, 30 qt.	5.70	5.00	28.50
Nauplii Harvesters	20.00	7.00	140.00
Wooden Shelves	1000.00	1.00	1000.00
Flashlight, Charg. Port.	40.00	1.00	40.00
Utility Cart, Rubberized	124.90	1.00	124.90
Portable Aerator	50.00	1.00	50.00
Assorted Cleaning Utensils	NA	NA	100.00
			TOTAL 16586.89
ALGAE CULTURE FACILITY			
Algae Culture Tanks, 1.0 MT	215.15	20.00	4303.00
Algae Culture Tanks, 500 ltr	125.00	7.00	875.00
Glass Carboys, 20 ltr	43.82	10.00	438.20
Aspirator Bottles, 2.0 ltr	9.47	20.00	189.40
Erlenmeyer Flasks, 250 ml	3.03	20.00	60.60
Erlenmeyer Flasks, 125 ml	1.94	40.00	77.60
Stock Culture Tubes	NA	48.00	50.00
Glass Petri Dishes	3.79	24.00	90.96
Bunsen Burner	27.00	2.00	54.00
4-Bulb Light Banks, 160 watt	100.00	35.00	3500.00
Inoculating Loops	22.13	2.00	44.26
Hand Counters	41.20	2.00	82.40
Disposable Pipet, 1.0 ml	0.14	500.00	71.40
Disposable Pipet, 2.0 ml	0.18	250.00	44.23
Test Tube Racks	19.30	2.00	38.60
Pipet Cannister, Autoclave	19.64	2.00	39.28
Hemocytometer	66.00	4.00	264.00
Compound Microscope	1408.00	1.00	1408.00
Salinometer	360.00	1.00	360.00
Air Conditioners	1500.00	4.00	6000.00
Carboy Culture Shelf	400.00/Unit	3.00	1200.00

DESCRIPTION	UNIT PRICE (US\$)	UNITS	EXTENDED PRICE (US\$)
ALGAE CULTURE FACILITY con't.			
Autoclave, Upright	5000.00	1.00	5000.00
Pressure Cooker	230.00	2.00	460.00
Utility Cart, Rubberized	124.90	1.00	124.90
Jerrican, w/spigot	26.75	10.00	267.50
Round Nutrient Bottles	1.24	12.00	14.84
Wooden Transfer Hood	50.00	1.00	50.00
Refrigerator w/freezer	600.00	1.00	600.00
Submersible Pump	124.00	2.00	248.00
Miscellaneous Glassware	NA	NA	200.00
Miscellaneous Plasticware	NA	NA	200.00
Miscellaneous Cleaning	NA	NA	100.00
Miscellaneous Nutrients/Chemicals	NA	NA	750.00
			TOTAL 27206.17
GENERAL HATCHERY LABORATORY			
pH Meter, Stationary	1570.00	1.00	1570.00
pH Meter, Portable	495.00	1.00	495.00
ORP Probe for pH Meter	135.00	1.00	135.00
ORP Test Solution	25.00	1.00	25.00
Assorted pH Buffers	NA	NA	50.00
Oxygen Meter, Portable	1195.00	1.00	1195.00
Salinometer	360.00	1.00	360.00
HACH Drel 7 Kit	2500.00	1.00	2500.00
Compound Microscope	1408.00	1.00	1408.00
Bacteriological Test Kit	595.00	1.00	595.00
Aquaculture Test Kit	350.00	1.00	350.00
Magnetic Stirrer	172.50	2.00	345.00
Refrigerator	600.00	1.00	600.00
Top Loading Balance	1895.00	1.00	1895.00
Miscellaneous Glassware	NA	NA	200.00
Miscellaneous Plasticware	NA	NA	200.00
Miscellaneous Chem/Nutrients	NA	NA	300.00
			TOTAL 12223.00
LARVICULTURE			
6.0 MT Larval Rearing Tanks	1000.00	16.00	16000.00
Center Screens	75.00	16.00	1200.00
Postlarvae Harvesters	150.00	4.00	600.00
Submersible Heaters	250.00	16.00	4000.00
Protein Skimmers	45.00	16.00	720.00
Artemia Tanks, 100 ltr.	75.00	16.00	1200.00
Magnetic Stirplate	172.50	1.00	172.50
Triple Beam Balance	181.65	1.00	181.65
Blenders	50.00	2.00	100.00
Various Sieves	NA	NA	200.00
Miscellaneous Plasticware	NA	NA	200.00
Miscellaneous Cleaning	NA	NA	100.00
Additional Nitex Screen	NA	NA	200.00
			TOTAL 24874.15
QUARANTINE/DISINFECTION			
4.0 MT Quarantine Tanks	400.00	4.00	1600.00
Ozone Gen., Portable PH190	3551.00	1.00	3551.00
Small Thomas Compressor	350.00	1.00	350.00
Aeration Inj. System	300.00	1.00	300.00
Center Screens	50.00	4.00	200.00

DESCRIPTION	UNIT PRICE (US\$)	UNITS	EXTENDED PRICE (US\$)
QUARANTINE/DISINFECTION con't.			
Chlorine Drain Dispensor	150.00	1.00	150.00
Dissecting Microscope	610.00	1.00	610.00
Triple Beam Balance	181.65	1.00	181.65
Miscellaneous	NA	NA	300.00
			TOTAL 7242.65
OFFICE FURNITURE (office, other areas)			
Small 640K Computer, etc.	1000.00	1.00	1000.00
Citizens Band Set-up	750.00	1.00	750.00
Office Furniture	NA	NA	1500.00
Notebooks, Records	NA	NA	300.00
Whiteboard	75.00	1.00	75.00
Overhead Projector	350.00	1.00	350.00
Miscellaneous	NA	NA	500.00
			TOTAL 4475.00
STORAGE AREA			
Storage Shelves, Hand-built	NA	NA	1000.00
Plastic Nesting Bins	NA	NA	500.00
PVC Inventory	NA	NA	2000.00
Artemia Cysts, Cases	480.00	5.00	2400.00
Counter Top	250.00	1.00	250.00
Dollies, Carts, etc.	NA	NA	200.00
Miscellaneous Hardware	NA	NA	2000.00
glue, hammers, PVC cement, crowbars, hand saws, nails, skill saws, screws, drills, bolts, levels, silicon, screw drivers, tap and dye kit, fiberglass, tape measures, chlorine Alconox, nitex scree, paint, paint brushes, sandpaper, wrenches, ratchet set, files, wood rasps, wood, cutting torch, bottled O2, regulators, batteries (various), clamps, chisal voltmeter, wire, solder gun, solder, pliers, power cords			
			TOTAL 8350.00
WORKSHOP (FIXED ITEMS, NON-REMOVABLE)			
Work table, heavy-duty	300.00	1.00	300.00
Vises (heavy)	100.00	3.00	300.00
Table Saw	400.00	1.00	400.00
Drill Press	400.00	1.00	400.00
Brooms	25.00	2.00	50.00
Compressor, Cart-Type	400.00	1.00	400.00
Miscellaneous	NA	NA	200.00
			TOTAL 2050.00
SUPPORT AND ADMINISTRATION			
Light-Duty Truck	10000.00	1.00	10000.00
Automotive Supplies	NA	NA	200.00
30 kva Gen-Set	10000.00	1.00	10000.00
Fuel Storage Tank	500.00	1.00	500.00
Trash Bins	100.00	4.00	400.00
Incinerator	250.00	1.00	250.00
			TOTAL 21350.00
			GRAND TOTAL 195502.01

Aquaculture Equipment Suppliers

A list of equipment suppliers to the aquaculture industry can be found in Aquaculture Magazine's "Buyer's Guide" which comes out yearly, or in other publications such as "The North American Directory of Aquaculture" published in Canada.

New Research Developments of 1993

The Addition of Paprika (Nature's Highest Source of the Carotenoid, Astaxathin)

Researchers, at the Oceanic Institute in Hawaii, have noticed that after broodstock have been in a maturation

system for several months, the female ovaries begin to bleach from a bright red color, which produces high quality larvae, to a whitish color, with 10-20 percent lower survival to second stage zoea. In addition, the females' shell softened and turned a bluish color. In other shrimp, a blue color has been diagnosed as a carotenoid deficiency, suggesting that there is not enough pigment in the broodstock diet. Carotenoid was incorporated into the broodstock diet with the addition of paprika, nature's highest source of carotenoid, astaxanthin. This is done by marinating squid in paprika before feeding. As a result, larval quality and survival, as well as broodstock ovary color and shell hardness have improved.

Adding Enteromorpha to Broodstock Diet

The addition of Enteromorpha to the feeding regime is recommended by some hatcheries. Enteromorpha (green algae) can be collected fresh from rocks below the tide level. Microwaving is suggested to pasteurize the algae before feeding it.